

NEW * High Dynamic Range 70CM Transverter Kit *** NEW**
 DEM Part Number 432-28

Operational Overview

The New DEM 432-28 is a 70cm to 28 MHz transverter with a list of new features that allow it to be more versatile in operation. It will operate with all 28 MHz. transceivers with transverter ports and with a simple option, it will be compatible with any 28 MHz. transceiver with 10 Watts or less output power. The 432-28 has a maximum linear output power of 30 watts and can be limited with an adjustable attenuator to preset the output power if you chose to use an additional power amplifier. The most noticeable improvement in the transverter is in the receive section. Additional filtering, (two separate helical filters) a high biased GaAs-FET preamplifier coupled with the existing high level mixer (+17 dBm Local Oscillator), provide a sensitive, yet over-load proof front end with superior out of band rejection. This is the best receive converter on the market today! The 432-28 has a built in transmit / receive relay but provisions have been made to allow separating the transmit and receive ports to add a high power amplifier or to interface the transverters additional receive filtering with a external or mast-mounted preamplifier. Additional options have been included to custom tune your receive gain requirements to obtain the best performance (sensitivity and IMD) possible.

Dual oscillators are provided for operation in the satellite portion of the band. Keying options for +1 to + 15VDC, PTT-H or a closure to ground, PTT-L, have been provided. Auxiliary relay contacts to control external transmit and receive functions are available. A common IF option that will operate at drive levels between -20dBm and 10 watts may be purchased separately. All IF connections are BNC connectors. The control, power, and auxiliary connections are RCA jacks, and the 70cm connectors are Type 'N' (2 supplied). The 432-28 is housed in a 8.7" x 5.7" x 2.2" aluminum die cast enclosure with an external 8 1/2" x 4" x 3/4" heat sink to provide cool operation under any condition.

DEM 432-28 Operating Specifications

Operating Voltage	11.0 - 16.5 VDC, 13.8 nominal
Current Drain	6 amps maximum on Transmit, 600 milliamps on Receive
Output Power (Standard)	Maximum 30 W linear. Output has 25 dB of adjustable range. Minimum 1 mW (0dBm) for 10 watts output power.
Output Power (Optional)	The same output power can be achieved, with -20 dBm or up to 10 watts of drive depending on the option used
Receive Noise Figure and gain	1.0 dB maximum, 0.8 dB nominal, @ 17 dB conversion gain for best receive intermod performance. Other gain options are available that will affect system noise figures, and IMD performance.

Assembly Options

Common IF input/output option	1 - 10 Watt IF drive option
External TR switching control	-20 dBm IF drive option
Separate Transmit and Receive ports	External preamplifier option
+1 to 15 V TTL or PTT ground keying	Factory alignment available on all kits

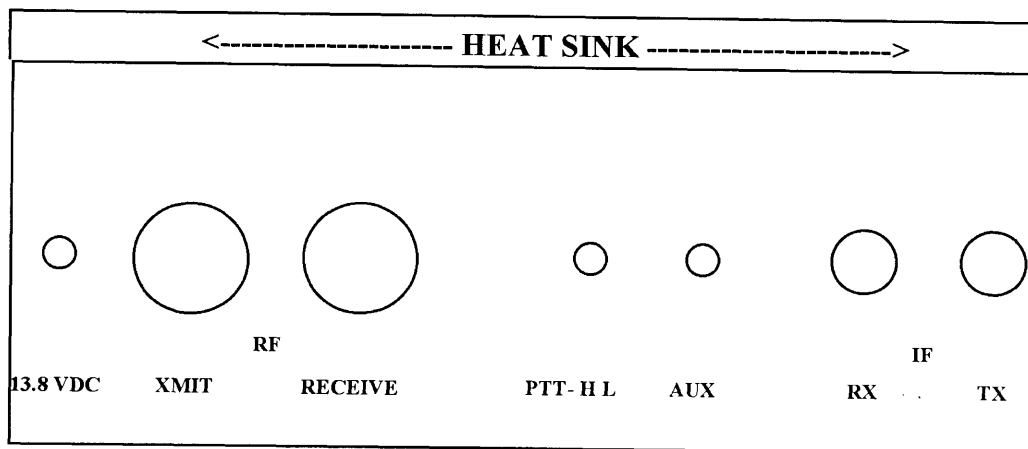

Connect your transceiver to the transverter:

Interfacing the transverter to the transceiver is easy. If your transceiver requires a DEM TIB, follow those instructions for interfacing. If the transverter was configured for direct connection to your transceiver, follow the steps listed below.

1. Open lid of transverter by removing 6 screws.
2. Depending on the make and model of your transceiver, it may or may not be necessary to enable the transverter ports. Follow whatever instructions you have in your transceiver's operation manual to enable transverter operation. If it requires a special connector or cable assembly, it should be made now or contact Down East Microwave for assistance.
3. Connect all IF cables. Both receive and transmit are BNC connections on the transverter. Use good quality coax cable to connect the 28 MHz. transverter ports from your transceiver to the TXIF and RXIF connectors on the transverter.
4. Connect the Push to Talk line out of your transceiver to the transverter. It is labeled PTT-H or PTT-L on the transverter and uses a RCA connector. The correct keying type is already configured for your transceiver.
5. Connect the 70cm antenna system or a dummy load with a power meter to the transverter. If one of the "N" connectors is labeled 'Antenna' then the internal transfer relay in the transverter is installed. Both transmit and receive functions will be provided through this connector. If the "N" connectors are labeled "Transmit" and "Receive", the internal transfer relay has been bypassed and the separate ports will provide the labeled functions.
6. Connect the DC power to the transverter. It uses a RCA type connector. 13.8 volts is optimum but the transverter will operate normally from 12 to 15 volts.
7. Preset the TXIF and RXIF gain controls. Turn the TXIF fully counter-clockwise (maximum attenuation) and the RXIF fully clockwise(minimum attenuation).
8. Power your transceiver on and leave it in the Receive mode on 28.100 MHz.
9. Apply power to the transverter and turn on the power switch. The power LED should light and the transmit LED should not. Set the local oscillator switch to 432MHz.
10. Adjust the RXIF gain control counter-clockwise until a slight noise increase is heard in the transceiver or just a slight movement in the "S" meter is detected. Power the transverter on and off to verify the change. The RXIF gain may be increased beyond this point, but it will start to degrade the dynamic range of your transceiver. Find a signal on the band or use a signal generator to determine correct

Printed Circuit Assembly Notes:

Your kit is provided with easy to read component placement diagrams that show the component placement and the reference designators that correspond to the provided component list (Bag 1 - Bag 4). Each side of the printed circuit board (PCB) is also shown to eliminate mirror image assembly errors. The top and bottom side assembly operation should always begin by aligning the PCB outline with the outline of the component placement diagrams. Use the notches on the longer sides of the PCB board as a key. You may also use the printed lettering on the top side of the PCB board for an indicator. You will also notice on the assembly diagram that there are circles, double circles, and "X" shown. These are shown to provide locating help when installing components. Components are mounted in the single holes. **Double Circles are Mounting Holes and Holes with "X" are for Wire installation only!**

Assembly Tips:

Soldering surface mounted active components (transistors etc.):

- The DOTS on the MMICs (IC1 - IC4, IC6 - IC8) determine their orientation and must be observed and positioned correctly prior to soldering. The GaAsFET (Q6) and Bipolar (Q5) orientation is determined by their lead formation, either longer or angle cut. The GaAsFET (Q6) angle cut lead or dot is the Gate side which corresponds to the assembly diagram (See Figure 1B). The long lead on the Bipolar (Q5) is the collector and corresponds to the assembly diagram (See Figure 1A). Leads on all active surface mounted components should be somewhat flat against the mounting surface, if they are not, a tool such as a small bladed screw driver can be used to flatten them. (See Figure 2).
- Align the component in place based on the diagram.
- While holding the component in place, solder one lead to hold the component in place and observe the alignment of all leads.
- If the alignment is acceptable, solder the remaining leads. You need enough solder to cover the lead and mounting surface for the entire lead length. Additional amounts results in a smaller solder roll! (See Figure 2 shaded areas)

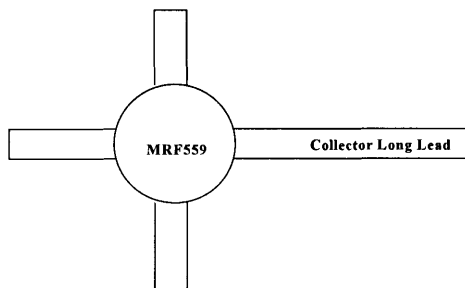

Q5 Figure 1A

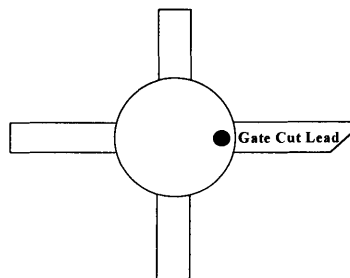

Q6 Figure 1B

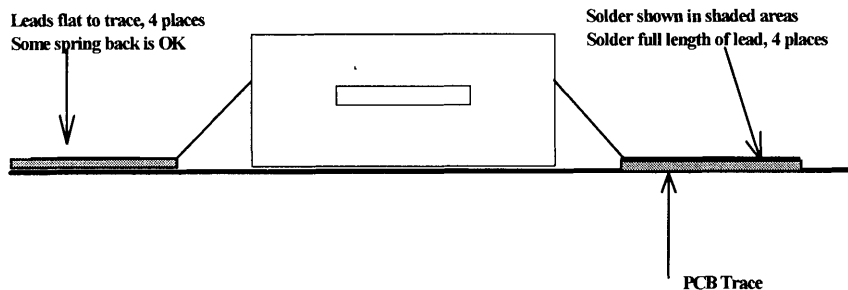

Typical side view of four leaded surface mounted device, lead bending close to body
Figure 2

Soldering surface mounted passive components (chip resistors / capacitors):

- Determine the component mounting position based on the assembly diagram.
- Without the component in place, heat one side of the mounting area and flow a small amount of solder on it.
- Place the component in the correct position per the assembly diagram, it should now have one end over the previously melted solder.
- Holding the component in place with tweezers or other soldering aid, heat the end with the previously melted solder and allow it to flow into the solder, once solidified, remove holding tool.
- Now heat and flow the solder to the other side of the component and your done!

Soldering leaded components (resistors, capacitors, diodes, etc.):

Depending on your available tools, you can solder your transverter's components from either the top or bottom of the PCB. It is suggested for the home assembler to use a method that is comfortable. A simple holding vise can be utilized to allow the components to be 'dropped in' from the top side and soldered on this side without flipping over the assembly. As an alternate method, you can insert one component at a time in the correct mounting location and gently push down to the circuit board, while holding the component, flip over the circuit board and bend the leads over in opposite direction to hold the component in place. Although this is the most reliable method, there are some draw backs if the component must be removed when the PCB is installed in the enclosure.

Rework of soldered components if needed:

The easiest method to rework soldered components is to employ a de-soldering braid that is specifically designed for this purpose. It can be purchased at any electronics store. Place the de-soldering braid on the lead that you are removing and apply heat to it. Without excessive pressure the solder will melt and flow into the braid leaving the lead or component ready to be removed.

The DEM 432-28 is fairly easy and fun to assemble even for the first time kit builder and can be completed in any order that is comfortable, however DEM Inc. suggests the following assembly procedure to minimize errors and possible frustration.

Surface Mount Component Suggested Assembly:

Referring to the PCB assembly diagrams you will see that there are six (6) surface mounted active components (MMIC, transistors) on the back side and three (3) on the top. All three of these top side active components may be installed as options depending on whether your application requires them or not. See page 11 for details of these options.

The assembly operation should begin by orienting the PCB with the top side assembly diagram. Orientation can be determined by observing the notches on the long sides of the PCB. *Observed polarity using either the DOTS or lead configuration as explained in the Assembly Tips section.*

Surface Mount Component Suggested Assembly;

1. On the **TOP** side, depending on your requirements, install and solder Q4, IC7 and IC8.
2. On the bottom side, Solder Q5 in place, then install and solder the balance of the bottom side active components IC1 - IC4, IC6.
3. Recheck orientation of all active devices installed with component placement diagram.

General Assembly

Install C46 - C51, C54 - C56, C59 - C61, R24, R25 & R26. These are surface mounted components located on the top side of the PCB. Follow the surface mounted passive component assembly tips presented earlier in this document.

L1, L6, L12, L13, L17, L18, L19, L20, and L22 must be formed prior to installation. The coils should be wound around the 1/8" wooden mandrel. Winding coils is not an exact science and you should not be intimidated by it. Using the supplied #24 enamel wire, extend about 1/4" in a perpendicular direction off of the mandrel and wind the wire around it, counting each evolution as one turn. When the total number of turns is completed (BAG 3 component list) cut the wire an additional 1/4" beyond the mandrel. Form the two leads so they are pointing in the directions shown in the forming side view details.

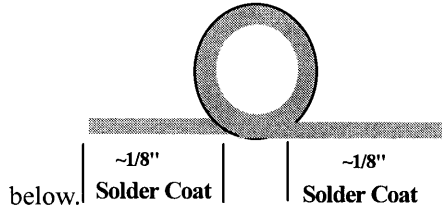

L17, L18, L19, & L20

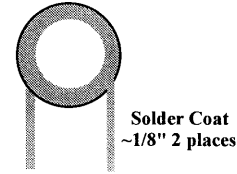

L1, L6, L12, L13, & L22

Dress the turns together if they are out of shape from winding, remove the coil from the drill bit. The coil forming is complete! To ensure a positive solder connection, the 1/8" leads should have the enamel insulation removed prior to soldering. This can be accomplished by applying solder to a hot soldering iron tip and placing the lead in the molten solder, you will see the insulation bubble indicating that it has melted (The tinned lead should be a silver color indicating that the insulation has been removed and the solder has tinned the base metal, if not repeat the process). As an alternative, the enamel can be removed by scraping the 1/8" leads with a razor blade until the base metal is exposed. Solder coat the exposed base metal, do not allow the outside diameter to increase so that the coil will not fit in the mounting hole.

Install and solder all prepped inductors as shown on the component placement diagram. Surface mount and through hole.

Now assemble and solder the components in the following suggested order as shown on the component placement diagram.

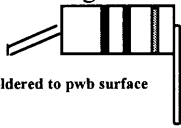
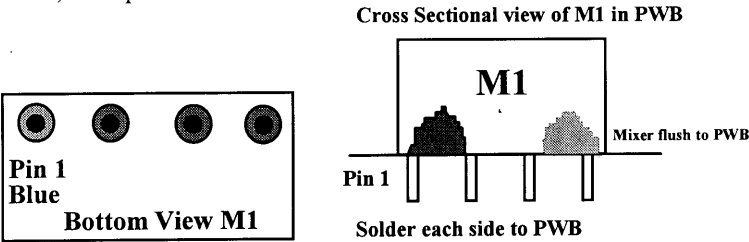
STEP	OPERATION and NOTES
1	Form, install and solder CR1 - CR10 Note: Ensure proper polarity
2	Form, install and solder L2 - L5, L7 - L11, L14 - L16, L21, L23 - L28 molded Chokes
3	Install and solder C2 & C13. The leads may have excess solder on them and may not fit into PCB holes.
4	Form, install and solder all leaded resistors including R35 and R38. Surface mount one lead of R27. <div style="text-align: center;">  Forming Detail of R27 </div>
5	Form, install and solder all leaded capacitors. Note: Ensure proper polarity on all tantalum capacitors as shown on the assembly document
6	Install and solder Q1 - Q4, Q7, VR1 - VR4 Note: Ensure proper polarity
7	Install Y1. Install Y2 crystal if ordered as an option. Second Xtal. may be installed at a later date.
8	Looking at the exit point of the leads of mixer M1, notice that one is colored blue (see below), this is pin 1 and should be installed in the Pin 1 hole on the PCB. Solder the leads, then on the top side apply solder from the case to the PCB surface, one spot on each side <div style="text-align: center;">  Cross Sectional view of M1 in PWB Bottom View M1 </div>
9	Install Relays K1, K2
10	Install Filters F1 - F4. Do not bend over the case tabs. Solder all leads on the bottom side

Install and solder wires in the shown areas on the component placement diagram (holes with an "X") per the table below. Do not lay wires directly on the board or route underneath the PCB. Even though this makes for a neater assembly, doing either will cause undesired oscillations and spurious responses.

Strip $\approx 1/4$ " from each end and solder tin the end prior to installing the wires. **NOTE:** Flying leads are wires that will be connected later in the assembly process.

WIRE	FROM	TO	SIZE
#26 Teflon	TXON near R31	TXON near C44	6"
#26 Teflon	+13.8 SW bus near R41	Flying Lead (for Power Switch)	2"
#26 Teflon	+13.8 SW bus near R41	Flying Lead (for LO switch)	4"
#26 Teflon	+13.8 SW near CR7	+13.8 SW near K2	3 "
#26 Teflon	+13.8 SW bus near R41	+13.8 SW near K1	3 1/2"
#26 Teflon	+13.8 SW bus near R41	+13.8 SW near R16	3 1/2"
#26 Teflon	TXLED	Flying lead	2"
#26 Teflon	LO1	Flying lead	2"
#26 Teflon	LO2	Flying lead	3"
#22 Teflon	RXIF	Flying Lead	1 1/4"
#22 Teflon	TXIF	Flying Lead	1 1/4"
#26 Teflon	RXON near R32	RXON near VR4	3 1/2"
#26 Teflon	TR near Q7	TR near K2	3"

Select the type of keying function for the transverter. This input is required for keying the transverter and will depend on your transceiver. **Consult your transceiver's manual for details if you are not sure.** Either a PTT- High (+1 to +15 VDC) transmit keying or a PTT - Low (Push To Talk to ground) are the choices. Install and solder a 4" #26 Teflon wire in the desired connection and leave it as a flying lead. If you plan to use an external amplifier or preamp that requires a transmit key line, the extra set of contacts in relay K1 may be utilized. The contacts are marked C (Common) NO (normally open) and NC (normally closed) and are referenced to Receive. You may connect the C to either ground, (any via hole) or a voltage (+13.8SW) if required. Use the supplied #26 Teflon wire. Then depending on your requirements, either the NO or NC may be connected to the AUX jack on the back wall of the transverter after the PCB is installed.

Post soldering

All leads including wires extending through to the bottom side of the PCB should be **trimmed as short as possible** to eliminate possible shorting to the enclosure when installed. Look over your work for solder bridging to adjacent traces, incorrectly installed components, and missing components.

Now refer to the bottom side component placement diagram and review the positioning of the brass angle. Position it as shown and solder it to the ground plane. It is suggested to re-flow the solder under the F2 filter. This may be a high spot on the board and it is important to not have any gaps between the brass angle and the ground plane but also have the brass as flush to the ground plane as possible. The printed circuit is now ready for testing.

PCB assembly into the enclosure.

The heat sink and enclosure are machined at the factory for your convenience. Notice that the heat sink, enclosure and the PCB have corresponding holes which are directional and must be aligned correctly. The heat sink and the enclosure are attached with a common screw / nut combination. Installation in the enclosure is easy if the suggested assembly steps are followed.

If not already done, remove the cover from the enclosure and wipe the inside clean to remove any remaining metal particles that may have been trapped during machining.

Aligning the enclosure's and heat sink's machined holes, place the heat sink on the enclosure. Then insert one # 4-40 cap screw in a machined hole from the "fin" side of the heat sink. While holding the screw in the heat sink with the provided Allen Key wrench, start a 4-40 nut on the screw threads inside of the enclosure and hand tighten only. Install one more screw in a diagonal location from the last screw and hand tighten only. Install the balance of the screw / nut combinations and tighten nuts. Do not install cap screws in the threaded holes of the heatsink!

Now install all of the connectors in the enclosure. Using Figure 3A and 3B, install the type "N" connectors as shown. Cut the center pins to 1/8" in length. The coaxial cable will be installed on the connector after it is attached to the PCB. Refer to Figure 3B. for this at a later time.

Now install the remaining rear wall mounted connectors, per the location in Figure 4:

Prepare the solder lug as shown prior to installing

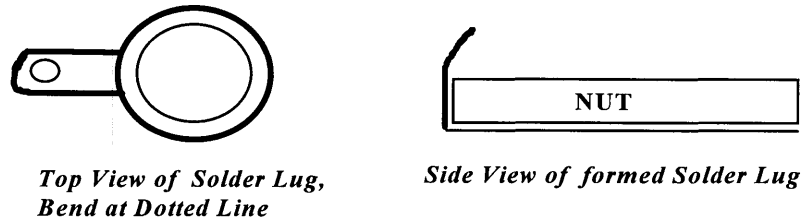

Figure 3A

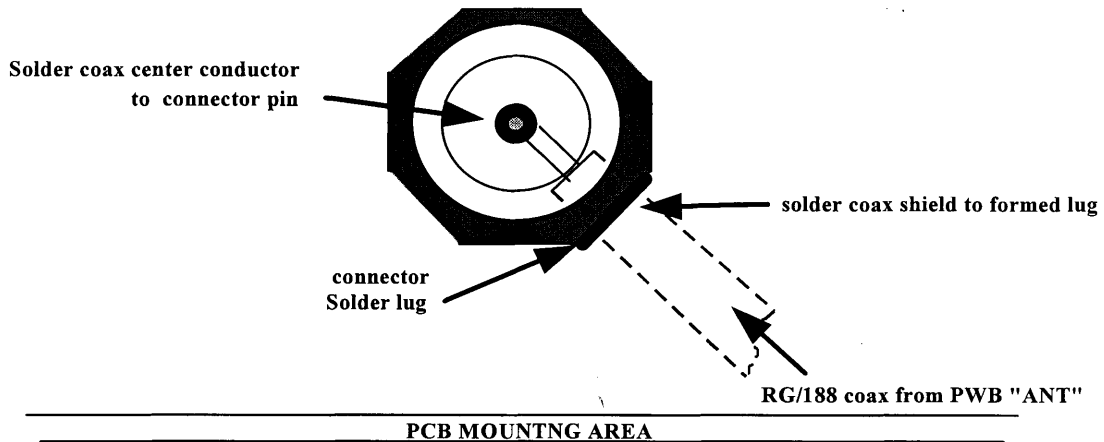

Figure 3B Inside View of Enclosure, Solder Lug Installation on the 'N' or UHF Connector

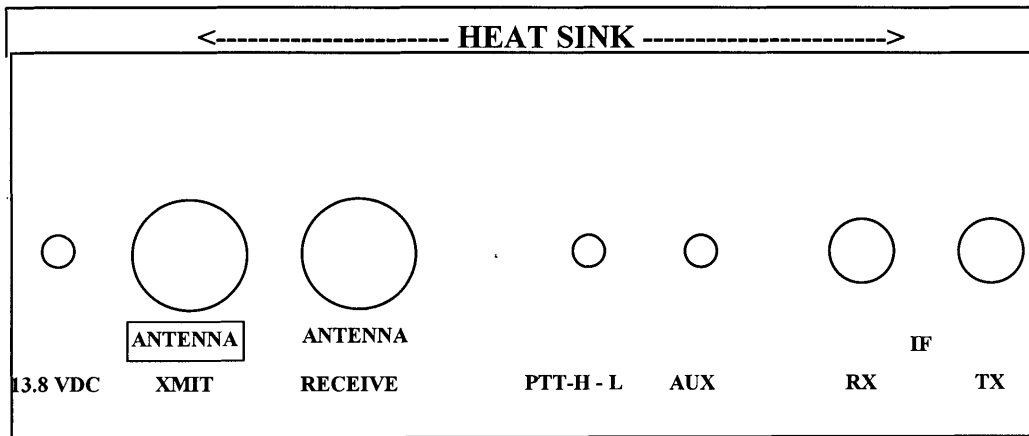

Figure 4 Jack Mounting Positions Outside View

- 2 - BNC connectors at the RXIF and TXIF positions using the supplied 3/8" nuts. If washers are supplied, install them on the inside of the enclosure. Do not install solder lugs. If you have difficulty tightening the connector, connect an adapter or cable connector and hold this while tightening to keep it from spinning.
- 3 - RCA connectors for AUX, PTT-H-L and 13.8VDC using the supplied hardware. The flat washer should be installed under the solder lug on the inside of the enclosure. After tightening, the lug should be bent away from the wall.

PCB assembly into the enclosure, continued.

Place the finished circuit board over the twelve 4-40 screw / nut combination and gently push flat against the nuts. Place two nuts on opposite corners on the screws extending through the PCB and tighten evenly. If any miss-alignment occurs with the 4-40 screws and the PCB mounting holes, simply note the position of the screw relative to the PCB and loosen that screw only. Replace the PCB and use it as a guide for alignment. Then tighten the loose screw and proceed.

- 1 -Mount the POWER switch using the supplied hardware. Mounting of the switch should be so it is toggled per Figure 5.
- 2 -Mount the LO2-432 switch using the supplied hardware. Mounting of the switch should be so it is toggled per Figure 5.

At this point, some of the flying wires will need to be connected in the enclosure to allow preliminary electrical testing.. Refer to Figures 4 and 5 for correct connectors.

Connect the #26 Teflon (PTT-L or PTT-H) wire to the wall mounted RCA jack, then connect a 1000pF capacitor (labeled "102") to the center pin and solder lug and solder. (See Figure 4 for jack location).

Connect and solder the #26 Teflon wire from LO2 on the PCB to the lower terminal on the LO switch. This terminal will be closest to the printed circuit board.

Connect and solder the longest #26 Teflon wire from the +13.8SW bus near R41 to the middle terminal on the LO switch.

Connect and solder the #26 Teflon wire from LO1 on the PCB to the terminal closest to the opening on the wall mounted LO switch.

Connect and solder the #26 Teflon wire from the +13.8V on the PCB (near C53) to the middle terminal on the wall mounted POWER switch and solder.

Connect and solder the last #26 Teflon wire from the +13.8SW bus (near R41) to the terminal on the wall mounted POWER switch that is closest to the opening in the enclosure.

Connect a 3" piece of #18 Teflon wire(Blue) and strip 3/8" on each end. Solder to the center of the wall mounted DC power jack (13.8VDC) then route the other end the wire to the pad labeled +13.8V, near C53. This end of the wire will be placed on the surface and soldered. There are no holes to insert the wire in on this pad. Then Connect and solder the 100µF capacitor to the DC power jack, observed polarity, positive lead to the center pin of the jack, negative to the ground terminal.

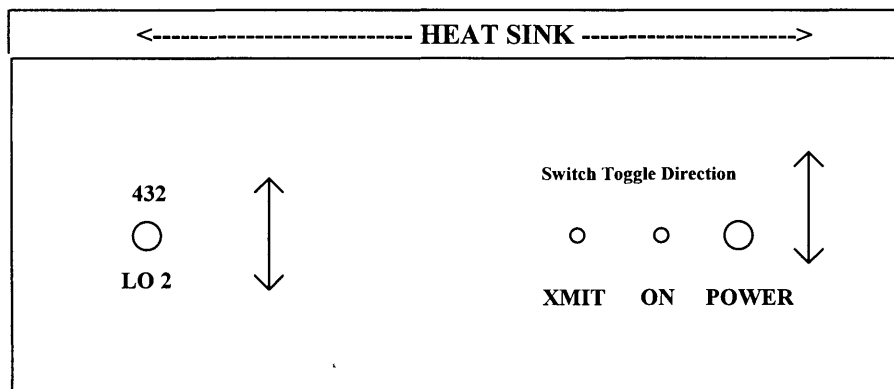

Figure 5 Switch / LED Mounting Positions

Electrical Test Verification of PCB. Receive only:

Apply 13.8 volt, current limited supply (.5 amps) to the RCA DC Power jack. The center pin is positive. Turn on the power switch. The transverter will now be in the receive mode. Check the voltages in the order shown, on the test table then continue by checking the oscillator section. Voltages are referenced to ground which is the enclosure. Use the component placement diagram for test point location.

TEST	Test Point Location	VOLTAGE
RX1	+13.8SW	Power supply Voltage
RX2	Junction of C63 & R27	9.0 ± 0.5VDC
RX3	Junction of R27 & Q6	1.5 - 4.5 VDC ❖
RX4	Junction of R28 & L21	5.0 ± 1.0VDC
RX5	Leg of C62, L21 side	1.8 ± .5VDC
RX6	Junction of R17 & C31	5.0 ± 1VDC
RX7	Leg of C29, R17 side	1.5 ± .5VDC
RX8	Junction of R16 and C29	5.0 ± 1VDC
RX9	Leg of C28, R16 side	1.5 ± .5VDC
RX10	Junction of R15 and C24	2.0 - 7.5 VDC
RX11	Leg of C23, R15 side	1.5 ± 1.0VDC
RX12	Verify LO1 and LO2 correspond to Switch	Power supply voltage
RX13	Junction of R32 and IC8 (if installed)	5.0 ± 1VDC
RX14	Junction of C77 and IC8 (if installed)	1.8 ± .5VDC

❖Due to variances in the GaAs FET devices you may need to adjust the Drain current. Optimal performance occurs between 50-65 mA as measured across R27 as $I \text{ in mA} = E \text{ (voltage drop across R27)} \div R27$. The current may be adjusted by either removing either R25 or R26 (to lower current) or adding an extra 24 ohm resistor (to increase current).

RX Test Trouble shooting

Failed TEST	Probable causes
RX1	+13.8SW shorted to Ground, Power supply in current limit, Missing wire.
RX2	Missing +13.8SW jumper, Output on VR4 shorted to ground.
RX3	If voltage higher than 5.0V, Q6 is damaged. Check R25,26. If voltage too low, increase Q6 source resistance
RX4	Check value of R28. L21 open or shorted to ground. IC6 shorted to ground, defective, or installed incorrectly.
RX5	If RX4 test failed, replace IC6. If RX4 test OK, C62 is shorted or the input of IC6 is shorted to ground.
RX6	Missing +13.8SW wire. R17 wrong value or shorted. IC3 shorted to ground, defective, or installed incorrectly.
RX7	If RX6 test failed, replace IC3. If RX6 test OK, C29 is shorted or the input of IC3 is shorted to ground.
RX8	R16 wrong value or shorted. IC2 shorted to ground, defective, or installed incorrectly.
RX9	If RX8 test failed, replace IC2. If RX8 test OK, C28 is shorted or the input of IC2 is shorted to ground.
RX10	R15 wrong value or shorted. IC1 shorted to ground, defective, or installed incorrectly.
RX11	If RX10 test failed, replace IC1. If RX10 test OK, C23 is shorted or the input of IC1 is shorted to ground.
RX12	Switch wired wrong. If low voltage, wire, capacitor or regulator shorted to ground on the LO input on PCB.
RX13	R32 wrong value or shorted. IC8 shorted to ground, defective, or installed incorrectly.
RX14	If RX13 test failed, replace IC8. If RX13 test OK, C77 is shorted or the input of IC8 is shorted to ground.

If any of the above tests fail, repair or consult Down East Microwave before proceeding with the oscillator testing

Local Oscillator 1 (432) Testing:

Verify that there is a 101.000 MHz. crystal in the Y1 position. If there is only one crystal installed, it should be in the LO1 oscillator position. This test will not work if a crystal is not installed. Switch the LO switch to the 432 position. Probe TP1 with the positive lead of a Voltmeter. Adjust C2 for maximum voltage, note where the capacitor is positioned. A midrange position is preferred (see C2 or C13 diagram). If the capacitor is at the maximum position, spread coil L1, 1 to 2 turns and readjust C24 for maximum voltage, the capacitor should be near midrange, if not repeat. If the capacitor is at minimum position, repeat process but this time compress coil L1 and if necessary, you may need to wind a new coil with an extra turn and replace it. The final voltage at TP1 should be approximately 1.0 - 2.0 volts. If a frequency counter is available probe TP1 and adjust C2 for 101.00000MHz. If your frequency counter is capable of measuring up to 500Mhz you can also probe the junction of C31 and R17 to verify that four (4) times the fundamental frequency of the crystal.(404.00000 MHz.) is present. You may skip the rest of this test and start the LO2 test if you have installed a crystal in the Y2 position. If not proceed to the TX testing. If the frequency can not be obtained, skip to step #8 . If the specified voltage at TP1 cannot be obtained please continue the LO testing on the next page

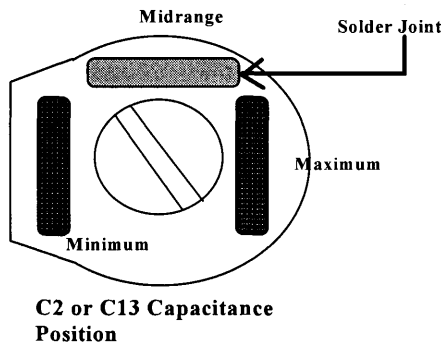

Local Oscillator Trouble Shooting Section:

It is possible that the voltage at TP1 may be low, but the oscillator is working perfectly. The crystals used in this circuit are 5th overtone design. If L1 is distorted enough or components are installed incorrectly, you may cause the oscillator to operate on a different overtone. **Crystal failure is a very rare occurrence!** If there is any voltage peek at TP1 while adjusting C2, and L1 does not vary much from its specifications, it should be assumed that the oscillator is operating correctly. For verification of this, perform the following tests 1 - 8. If the oscillator is off frequency, (404.00000) but it is close, skip to test #8.

1. Verify voltage at the junction of L5 and CR1. This should be 0.7VDC \pm 0.3 VDC. If it is high, CR1 is missing, installed backwards, damaged, or L11 is missing or open. If it is 0VDC, check for a short in the circuit after R7. Use schematic and component placement diagram. If you find an error in assembly, correct it and restart the oscillator test.
2. If the voltage is correct at the junction of L5 and CR1, probe the junction of R15 and C24 with a volt meter while adjusting C2. The voltage should vary. Adjust C2 for minimum voltage. If less than 4 volts can be achieved, the multiplier section of the oscillator is working correctly. If the voltage stays high (6 - 7 volts) and doesn't vary downward during the adjustment, the problem is in the main oscillator circuit.
3. With the volt meter, probe the junction of R5 and Q2. This voltage should vary when C2 is adjusted. If it does not vary, then the problem is in the Q1 circuitry. If it does vary and there is no change of voltage on TP1, then the problem is either a defective Q2 or its bias circuitry. Verify the suspected transistor by following step 4.
4. To verify the bias voltages of transistors Q1 and Q2, you do not need to measure these voltages at the transistors leads. It would be difficult and a mistake could occur by shorting 2 leads together and it would destroy the transistor. Examine the schematic and component placement diagram for exposed leads of other components that are connected to the desired test points. Start by verifying the output of the 9 Volt regulator, VR 1. Then check Q1. Collector = 9 volts. Base = 1.5 - 2.5 volts. Emitter = 1.3 - 2.2 volts. For Q2, collector = 9 volts. Base = 1.3 - 2.2 volts. The Emitter is TP1.
5. If these voltages do not check out correctly, you need to make the determination if the bias resistors, chokes and L1 are installed correctly. They may also have a solder bridge on the bottom side of the PCB. Remove the board from the enclosure and check. All of the resistors should check out with a ohm meter except R2 which is shorted with L1. Also verify the placement of Q1 and Q2. If the transistors are found to be installed incorrectly, or a solder bridge caused a wrong bias voltage (higher than specified) assume that the transistor is destroyed. You may still try it after repair, but it is unlikely!
6. If the voltages check out OK, verify that C4, C5 and C2 are installed correctly and do not have any solder shorts. Measure with an ohm meter.
7. If they check out OK, its time for the final test. Remove the Y1 crystal and L2 inductor. Be careful with L2. It is brittle! Now install a 51 ohm (36 - 75 ohm will work) resistor in the Y1 position. Apply power to the circuit and probe TP1. If you can obtain a voltage swing by varying C2, then verify what frequency it is operating on with a frequency meter or a FM broadcast radio. You should be able to adjust C2 for 101 MHz. If not, stretch and/or compress L1. If the frequency can not be obtained with the specified L1 size, then the oscillator circuit is assembled wrong or Q1 is defective. If you can not obtain any oscillation, also assume the same if all bias voltages are correct. If you can adjust the frequency, set L1 (stretch and/or compress) so that C2 is in the mid position. Leaving everything adjusted correctly, power down the circuit and remove the resistor in the Y1 position and re-install Y1 and L2. Power the circuit up. If it doesn't oscillate, you have a defective crystal.
8. If the oscillator is operating but the frequency can not be netted, verify that C2 is in mid position. If not re-adjust L1 to do so. If the oscillator shuts down when the frequency gets close, and C2 is in mid position, allow the oscillator to run at any frequency for 24 hr. before attempting re-adjustment again. You may continue the testing and assembly of your transverter. Just don't do the final assembly. If after re-adjustment, and you are sure of your frequency calibration (do not use a FM radio or HT for calibration!!!) and the L1 and C2 circuitry adjustment is correct, return the crystal for replacement.

Local Oscillator 2 Testing:

Only perform this test if there is a crystal installed in the Y2 position. Switch the LO switch to the LO2 position. Connect the positive lead of a Voltmeter to TP2. Adjust C13 for maximum voltage, note where the capacitor is positioned. A midrange position is preferred (see diagram above). If the capacitor is at the maximum position, spread coil L6, 1 to 2 turns and readjust C13 for maximum voltage, the capacitor should be near midrange, if not repeat. If the capacitor is at minimum position, repeat process but this time compress coil L6. You may need to wind a new coil with an extra turn and replace L6 with it. The final voltage should be approximately 1.0 - 2.0 volts. If a frequency counter is available probe TP2 and adjust C13 for your crystal frequency. If your frequency counter is capable of measuring up to 500MHz you can also probe the junction of C31 and R17 to verify four (4) times the frequency of the crystal is present. If the voltage or frequency can not be obtained, go back to the Local Oscillator Trouble Shooting Section. The LO 1 and LO2 circuits are identical. Use the LO1 trouble shooting section as a guide by substituting the correct designators on the component placement and schematic.

Transmit Electrical Test :

The voltage checks listed below are for the transverter in the TX mode with any oscillator enabled. After verifying that the DC power is connected to the transverter and the power switch is in the on position, place the transverter in the Transmit mode. This is done by keying the PTT-L or PTT-H circuit. Either ground or the +13.8V supply will work. This will also depend on how you have configured your transverter. As you enable the TX mode, a "click" may be heard from the relays on the PCB. All voltages are referenced to ground. (the enclosure)

TEST	Test Point Location	Correct Test Results
TX1	TR connection near Relay K1	0.7 VDC ±0.5VDC
TX2	ANT connection near K2 and K2 side of C56	Measure short with Ohm meter
TX3	TXON connections - All Positions	Power supply voltage
TX4	RXON connections - All positions	0 VDC
TX5	TXLED connection	Power supply voltage
TX6	Junction of C45, C46, and C47	9.0± 0.5VDC
TX7	Across R23	0.6 - 1.1VDC
TX8	Junction of C37 and R19	5.0 ± 1VDC
TX9	Leg of C35 closest to R19	1.5 ± .5VDC
TX10	Junction of L22 and CR5	0.8± 0.5VDC
TX11	Junction of L27 and CR10	0.8± 0.5VDC
TX12	Junction of R33 and IC7 (if installed)	3.5 ± 1VDC
TX13	Junction of C83 and IC7 (if installed)	1.5 ± 0.5VDC

TX Test Trouble shooting

Failed TEST	Probable causes
TX1	Missing +13.8SW or TR jumper wires. Missing or defective Q7 , R29, or CR8
TX2	Defective K2
TX3	Defective K1, shorted TXON voltage to ground, If defective all other tests will fail.
TX4	Defective K1
TX5	R20 missing or shorted
TX6	VR3 Missing or shorted to ground. C45 installed backwards
TX7	If low, decrease the value of R22, If High, Check value of R23 then if OK increase the value of R22
TX8	If high, R19 wrong value. If low, R19 shorted or IC4 installed incorrectly.
TX9	If high, or low IC4 defective or installed incorrectly
TX10	If low, R18, L14, L22, missing .CR4 is backwards, damaged or missing. If high, CR5 is backwards or damaged
TX11	If low, R31, L28 missing. CR9 is backwards, damaged or missing. If high, CR10 is backwards or damaged
TX12	If high, IC7 defective. If low, missing jumper wire, defective IC7, solder short, wrong value R33
TX13	If low defective IC7 or installed incorrectly. If high IC7 defective

****If any of the Transmit tests fail, repair or consult Down East Microwave before proceeding with the Kit!!!****



If all the test pass, go to page 18 of this document for instructions of mounting the PTC-50 Thermistor. The Thermistor is used for frequency stability and does not need to be installed at this time but it is convenient. If you wish to install it at a later time, install the rest of the 4-40 nuts on the top side of the PCB and repeat a few of the electrical tests to verify that nothing was shorted on the PCB after assembly. The proceed below wit the power module installation.

POWER MODULE INSTALLATION

Place the power module (IC5) on the enclosure floor in its mounting location and trim the leads so they do not extend past the mounting pads, they should be approximately 3/8" long once trimmed. Wipe the mounting surfaces of the enclosure floor and flange of IC5 to *verify the surfaces are free any foreign matter and deep scratches before applying a thin even coating of thermal compound* to the mounting flange. Place IC5 on the enclosure floor while lining up the leads with the traces of the circuit board. Install two 6-32 x 3/8" screws through the mounting flange into the enclosure floor and tighten evenly. Then forming the leads flat to the traces, solder all leads of IC5 to the circuit board.

LED INSTALLATION:

Note: The longer lead on the LED is positive.

- Prepare the "XMIT" LED by supporting the **SHORT** lead (negative) at the LED body, bend the lead 90° away from the longer lead.
- Place the "XMIT" LED in the wall mounting hole (see Figure 5) and place the previously formed lead on the ground plane circuit close to the edge of board and solder.
- Cut the positive lead of the "XMIT" LED to approximately 3/8". Form a "J" in the lead by bending with pliers.
- Connect the #26 Teflon wire from the hole in the PCB near labeled TXLED, to the "J" formed positive lead on the "XMIT" LED.
- Place the positive lead of the "ON" LED in the hole by R41 labeled ON LED.
- Form the "ON" LED so that the body fits into the hole in the enclosure.
- Tack solder the ground side of the "On" LED to the ground plane

PCB assembly into the external enclosure, continued

- Connect a piece of #18 Blue Teflon wire from the wall mounted DC power jack (13.8VDC) and solder, then route the wire to the pad labeled +13.8V near the power output module and L16. Solder it to the surface (Note: There is a wire there already.) Connect and solder the 100µF capacitor to the DC power jack, observed polarity, positive lead to the center pin of the jack, negative to the ring ground terminal.
- Connect the #22 Teflon wire from the stand alone hole in the PCB labeled RXIF to the BNC RX jack and solder.
- Connect the #22 Teflon wire from the stand alone hole in the PCB labeled TXIF to the BNC TX jack and solder.

DEM 432 - 28 User Options

The following final assembly instructions cover all of the options that are available for this kit. This list of suggestions will help you decide which options you will want to install.

Common Antenna for both transmit and receive. If you plan to connect a antenna directly to the transverter or use a solid state amplifier with antenna switching built in, do this assembly.

Add an external preamplifier and bypass the internal GaAs-FET. If you plan to use a external or mast mounted preamplifier, this option is suggested. Any additional gain in front of the stock transverter will degrade the IMD performance, and reduce the dynamic range of the transverter by the amount of additional gain.

Common IF option. If you use and transceiver with a single transverter port or a transceiver with a power level up to 10 watts.

Split RX / TX Ports for high power amplifier use. If you plan to use a tube type amplifier with external preamplifier and sequenced switching schemes, such as a EME station, assemble this option.

Auxiliary Switching contacts. Used for external switching circuits or to hard key a solid state amplifier.

Install the TXIF or RXIF gain stages. Only if the TX drive is low from the transceiver. Only if RX gain is desired.

Common Antenna for both transmit and receive

Prepare the common output coaxial cable as follows: (See Figure 6)

Cut the coax 2" - 2 1/32" long.

Remove the outer insulation 1/2" from one end and 1/4" from the other.

Remove the braided shield 1/4" from the 1/2" stripped side.

Remove the braided shield 1/8" from the other side.

Remove the center conductor insulation from each end allowing an extension out of the remaining shield. Cut the center conductor wire to ~1/16" to prevent shorting.

Solder tin the center conductor on both ends and solder tin the shield on the 1/2" end.

Bend the center conductor on the longer stripped end 90°

Position the 1/2" stripped end on the circuit board by placing the center conductor in the hole on the board labeled "ANT". This hole is located near relay labeled K2.

Angle the coax so that it is facing K1. (See Figure 7)

Solder the shield to the ground area adjacent to the "ANT" hole for the center conductor, then solder the center conductor in the "ANT" hole.

Route the coaxial cable around the relay to the solder lug on the wall mounted 'N' connector screws.

Solder the shield to the solder lug, then solder the center conductor to the 'N' connector center pin as in figure 3A.

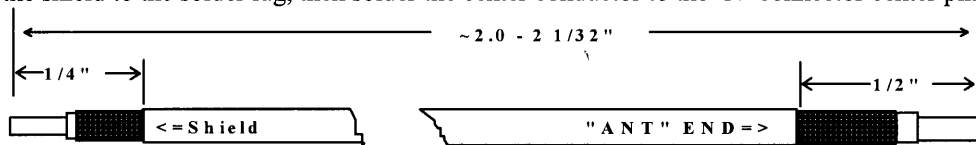

Figure 6 Cable shown broken for clarity

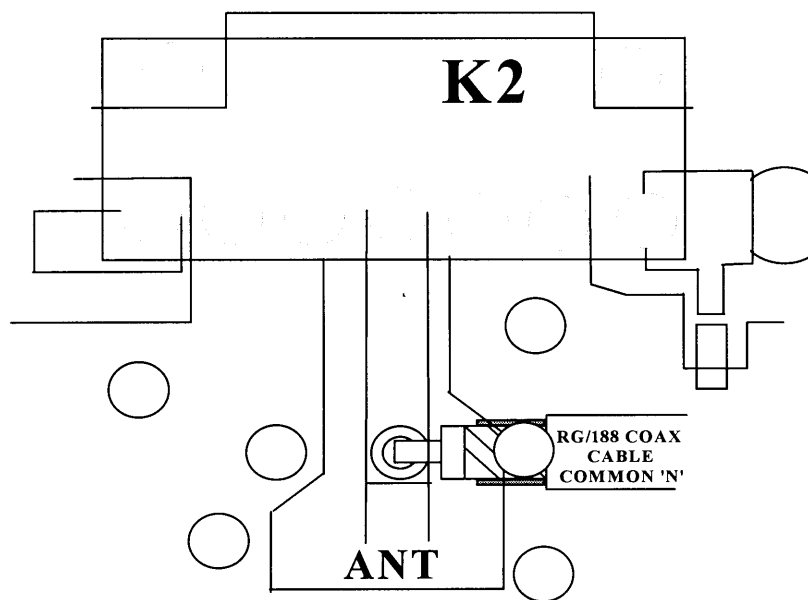
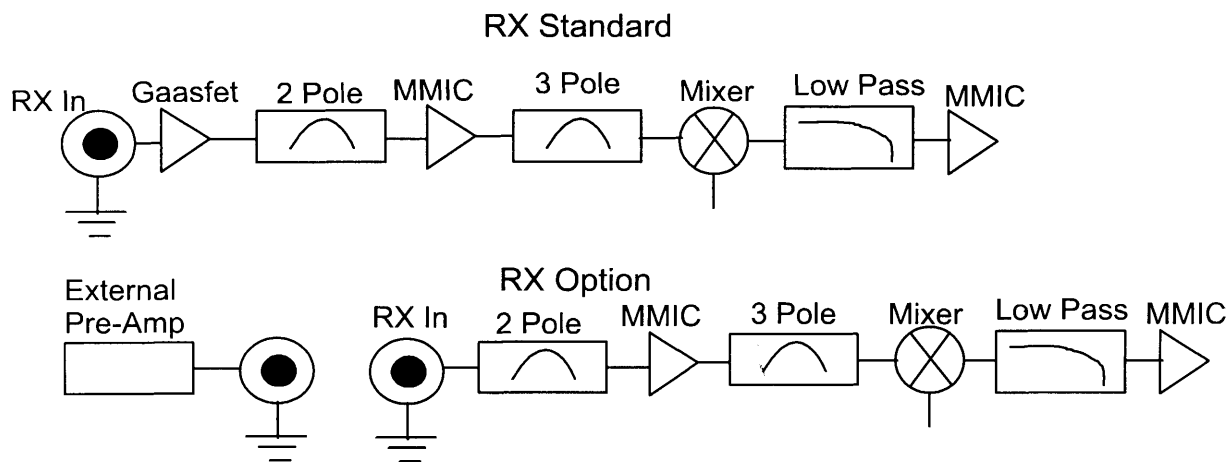

Figure 7 Coaxial Cable mounting on PCB shaded areas are solder points

Add an external preamplifier and bypass the internal GaAs-FET

On the following page is block diagram of the receive converter. It shows the standard and an option of using an external preamplifier. It is recommended that if you use an external or mast mount preamplifier, you should bypass the internal one. The transverter may be configured this way very easily.

1. Refer to the component placement diagram and reposition C61 to connect F4 to the unused pad by F4. This is now the RX input. Unsolder and lift up the end of R27 that is attached to Q6.
2. If you do not wish to have the receive signal routed through the T/R relay in the transverter, use a small length of coax to connect the new RX input to the spare N connector.
3. If you wish to still use the T/R relay in the transverter, remove R24 and C57 from the PCB. Then run a jumper coax from the R24 pad to the new RX input.



Common IF option

A common IF option is available for this transverter. If interested it can be supplied as a kit. Please consult Down East Microwave Inc. for details. Options with up to 10 watts input power are available. It is easily installed and comes complete with a new component placement diagram.

Split RX / TX Ports for high power amplifier use

1. Remove chip capacitor C56 from original position and place where shown on diagram below.
2. Prepare a 2" piece of RG/188 coax or similar and attach it to the new C56 placement as shown.
3. Attach the other end of the coax to the spare type "N" connector. Use the other connector as a sample.

The RX input can be left assembled the way it is. This will provide additional receiver isolation during transmit. The K2 relay will function normally and will open the circuit to the RX input. But this will not protect an external preamplifier. If you decide to remove the K2 relay from the circuit do step 4 and 5.

4. Remove and replace C57 and R24 as shown in diagram below.
5. Remove the coax from the ANT connection on the PCB and attach it to the new position shown.

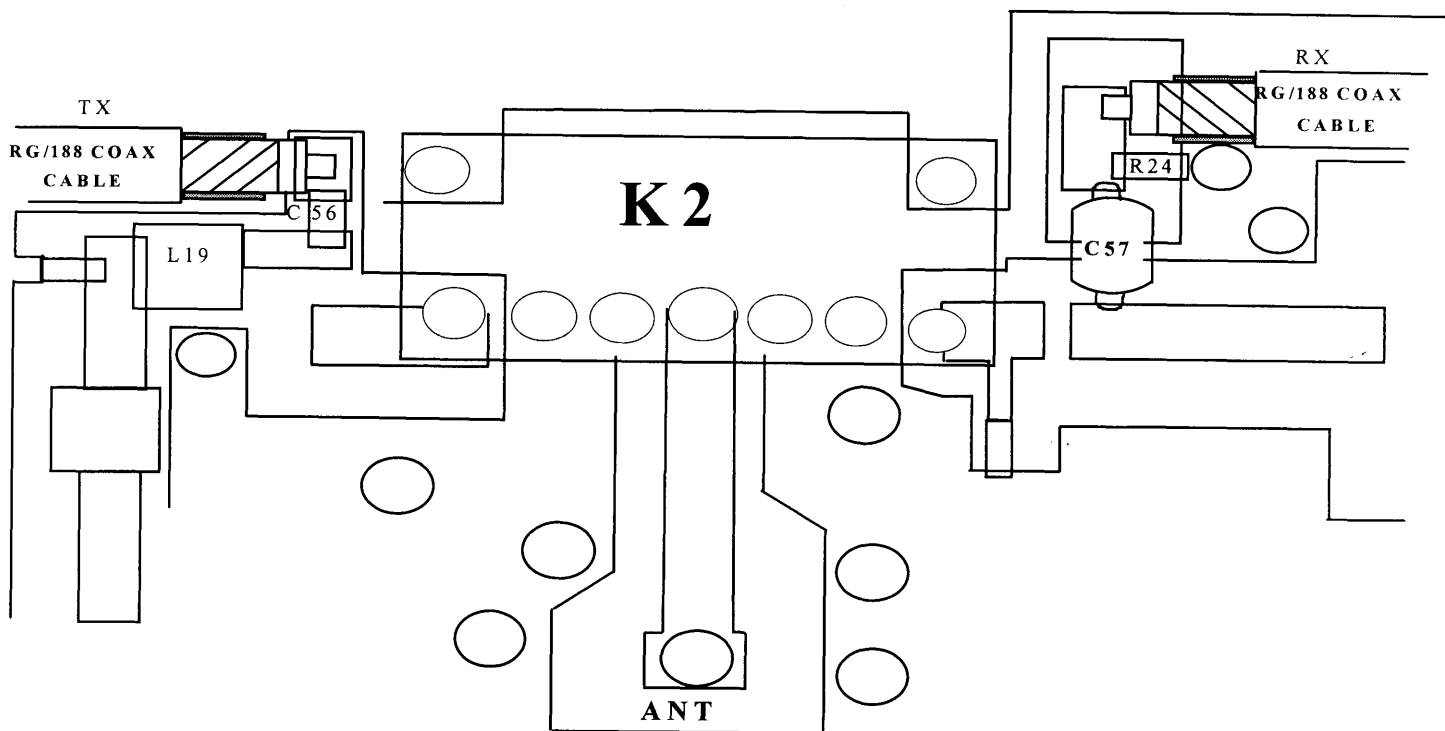

Auxiliary Switching contacts.

The auxiliary contacts in K1 are labeled C (common) NO (normally open) and NC (normally closed). The C connection can be wired to ground or +13.8 VDC. This will then be connected or dis-connected depending on whether the transverter is in transmit or receive. The contacts are marked for the receive mode. The NO or NC can be wired to the AUX connector on the enclosure.

Install the TXIF or RXIF gain stages.

You may require additional gain on either the TXIF or RXIF and want to install either IC7 or IC8. If your transceiver has less than 1 mW output on its transverter port, install IC7 will enable the transverter to produce full output power. All of the associated bias components are installed and tested. Refer to the component placement diagram and locate IC7. Then remove the ribs as shown below. Cut them with a razor knife and heat with a solder iron. They will jump off the board! Then form the leads of the IC7 so that it lays flat on the circuit board. Solder it into place paying attention to the Dot on the IC.

The same thing may be done with RXIF. Note the dot on the IC before installing. **Caution!** Installing this gain stage will increase your IF gain and will not improve your system's noise figure. Refer to the circuit description. This stage will decrease your systems dynamic range if you have already installed a external preamplifier.

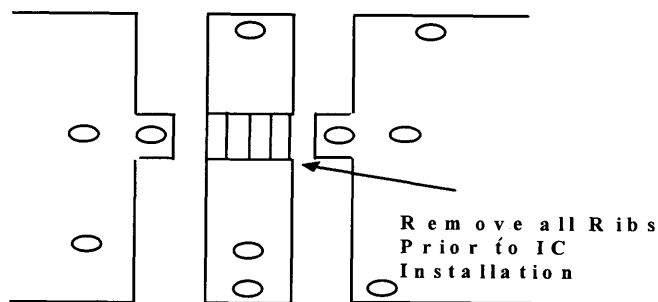

IC7 & IC8 Installation

Transverter Final Tune Up

The assembly portion of your kit is complete. You will now proceed with the final tune up as follows, after connecting your transverter to your IF rig:

Connect your transceiver to the transverter:

Interfacing the transverter to the transceiver is easy. If your transceiver requires a DEM TIB or AOS, follow their instructions for interfacing. If the transverter was assembled for direct connection to your transceiver, follow the steps listed below.

1. Depending on the make and model of your transceiver, it may or may not be necessary to enable the transverter ports. Follow whatever instructions you have in your transceiver's operation manual to enable transverter operation. If it requires a special connector or cable assembly, it should be made now or contact Down East Microwave for assistance.
2. Connect all IF cables. Both receive and transmit are BNC connections on the transverter. Use good quality coax cable to connect the 28 MHz. transverter ports from your transceiver to the TXIF and RXIF connectors on the transverter.
3. Connect the Push to Talk line out of your transceiver to the transverter. It is labeled PTT-H or PTT-L on the transverter and uses a RCA connector. The correct keying type should have been configured for your transceiver during assembly.
4. Connect the 70cm antenna system or a dummy load with a power meter to the transverter. If you chose to assemble split transmit and receive sections one of the "N" connectors is the transmit side. Put the power meter or load there. Place a signal generator or an antenna on the receive connector.
5. Connect the DC power to the transverter. It uses a RCA type connector. 13.8 volts is optimum but the transverter will operate normally from 12 to 15 volts.
6. Preset the TXIF and RXIF gain controls. Turn the TXIF fully counter-clockwise (maximum attenuation) and the RXIF fully clockwise. (minimum attenuation)
7. Power your transceiver on and leave it in the Receive mode on 28.100 MHz.
8. Apply power to the transverter and turn on the power switch. The power LED should light and the transmit LED should not. Set the local oscillator switch to 432MHz.
9. Adjust the RXIF gain control counter-clockwise until a slight noise increase is heard in the transceiver or just a slight movement in the "S" meter is detected. Power the transverter on and off to verify the change in noise. The RXIF gain may be increased beyond this point, but it will start to degrade the dynamic range of your transceiver. Find a signal on the band or use a signal generator to determine correct frequency, or minimum detected signal level. Out of band signals such as local repeaters will be attenuated if their output frequency is above 438 MHz or below 430 MHz.
10. To test the transmit section, place your transceiver in the CW mode. It is recommended to test the transverter in the CW mode because most transceivers have carrier level controls in this mode only. If your transceiver has FM, it may be used to test the transverter if it has a power output control. Do not use SSB or AM because it is not possible to obtain maximum output power with a transceiver in these modes. Set the carrier/output power control to minimum or "0" output power. Place the transceiver into transmit. Note the transmit LED on the transverter. It should be on. While observing the power meter on the 70cm system, slowly increase the carrier control (with key down) or power output control to maximum on the transceiver. If the transverter is configured correctly for your transceiver, minimal power may be detected on the 70 cm power meter. Now slowly adjust the TXIF control in the transverter in a clockwise direction while observing the power meter. Set it to obtain a maximum of 30 watts maximum. If a power meter is not available, you may use a current meter on the DC power line to determine if the transverter is transmitting. A maximum of 6 amps should be obtained and it should vary as the TXIF control is varied. If 30 watts can not be obtained with 6 amps of current drain, then with an insulated tool, stretch or compress the L17, L18, and L19 inductors in the output low pass filter. This will also help efficiency. After proper power is obtained, switch the transceiver to USB and make a transmission. The power output and current drain should correlate to your speech pattern. If a minimum of 25 watts can not be obtained, it could be a IF drive problem. Please consult Down East Microwave Inc.
11. You may re-adjust both RXIF and TXIF again if desired. The adjustments of the receive preamplifier and local oscillator frequency do not need to be touched but you may if you wish. Do not adjust any of the helical filters unless you have access to a spectrum analyzer at minimum.
12. Put the top on the enclosure and install the screws. Your transverter system is ready to use. Connect as you wish to use it in your 70cm system and have fun!

DEM 432-28 Component List

BAG 1

Resistors values are in Ohms and are ¼W unless otherwise specified. CC = carbon composition. Capacitors are chips and the values are pF unless otherwise specified. All chips are attached on a separate card in Bag 1.

R1 470	R12 47	R23 10	R34 220	C50 0.1µF CHIP
R2 680	R13 100	R24 1K CHIP	R35 1K POT	C51 1000 CHIP
R3 1.5K	R14 1K	R25 24 CHIP	R36 220	C54 6.8 CHIP ATC
R4 100	R15 330 ½ W CC	R26 24 CHIP	R37 220	C55 6.8 CHIP ATC
R5 47	R16 220 ½ W	R27 100 ½ W CC	R38 1K POT	C56 100 CHIP ATC
R6 100	R17 180 ½ W CC	R28 180 ½ W	R39 220	C59 0.1µF CHIP
R7 1K	R18 1K	R29 1K	R41 1K	C60 0.1µF CHIP
R 470	R19 240	R30 47	C46 1000 CHIP	C61 1000 CHIP
R9 680	R20 470	R31 1K	C47 0.1µF CHIP	
R10 1.5K	R21 100	R32 180 ½ W	C48 0.1µF CHIP	
R11 100	R22 1.5K	R33 330	C49 1000 CHIP	

BAG 2

All capacitors are disc ceramic and are pF unless otherwise specified. "ELECTR" = Electrolytic "Trimmer" = Variables "SM"=Surface Mount "TH"=Thru-Hole

C1 1000 (102)	C16 39	C31 120	C52 2.2µF ELECTR	C73 120
C2 1-6 Trimmer TH	C17 1000	C32 0.1µF	C53 2.2µF ELECTR	C74 1000
C3 1000	C18 1000	C33 120	C57 1-6 Trimmer SM	C75 270
C4 15	C19 2.2µF ELECTR	C34 120	C58 1-6 Trimmer SM	C76 270
C5 39	C20 2.2µF ELECTR	C35 120	C62 120	C77 1000
C6 1000	C21 1000	C36 1000	C63 120	C78 0.1µF
C7 1000	C22 1000	C37 120	C64 2.2µF ELECTR	C79 1000
C8 2.2µF ELECTR	C23 120	C38 1000	C65 2.2µF ELECTR	C80 1000
C9 2.2µF ELECTR	C24 120	C39 0.1µF	C66 1000	C81 1000
C10 1000	C25 0.1µF	C40 1000	C67 120	C82 0.1µF
C11 1000	C26 10	C41 1000	C68 1000	C83 1000
C12 1000	C27 10	C42 120	C69 1000	C90 1000
C13 1-6 Trimmer TH	C28 120	C43 120	C70 1000	PTC-50
C14 1000	C29 120	C44 2.2µF ELECTR	C71 39	
C15 15	C30 0.1µF	C45 2.2µF ELECTR	C72 18	

BAG 3

Hand wound (HW) inductors are #24 enamel wire, close wound. All molded chokes have GOLD or SILVER multiplier and tolerance bands. Please identify desired value by the significant color band combination.

L1 9 Turns 1/8" ID (HW)	L11 1.0µH (Black Body)	L21 0.47µH (YELLOW/VIOLET)
L2 0.33µH (ORANGE/ORANGE)	L12 4 Turns 1/8" ID (HW)	L22 3 Turns 1/8" (HW)
L3 1.0µH (Black Body)	L13 3 Turns 1/8" ID (HW)	L23 0.33µH (ORANGE/ORANGE)
L4 1.0µH (Black Body)	L14 1.0µH (Black Body)	L24 0.22µH (RED/RED)
L5 1.0µH (Black Body)	L15 0.47µH (YELLOW/VIOLET)	L25 0.22µH (RED/RED)
L6 9 Turns 1/8" ID (HW)	L16 1.0µH (Black Body)	L26 0.22µH (RED/RED)
L7 0.33µH (ORANGE/ORANGE)	L17 2 Turns 1/8" ID (HW)	L27 0.33µH (ORANGE/ORANGE)
L8 1.0µH (Black Body)	L18 3 Turns 1/8" ID (HW)	L28 1.0µH (Black Body)
L9 1.0µH (Black Body)	L19 2 Turns 1/8" ID (HW)	4' #24 Teflon Wire
L10 1.0µH (Black Body)	L20 3 Turns 1/8" (HW)	2' #24 Enamel wire

DEM 432-28 Component List continued

BAG 4

M1 TUF-1H Mixer	IC1 MAR8
Q1 2N5179 Metal can	IC2 MAR3
Q2 MPS5179	IC3 MAV11
Q3 2N5179 Metal can	IC4 MAR3
Q4 MPS5179	IC6 MAV11
Q5 MRF559 or 940P1 or 1359-1	IC7 MAR6 (TXIF Gain, optional)
Q6 ATF21186	IC8 MAV11 (RXIF Gain, optional)
Q7 PN2222	VR1 78L09
CR1 MPN3404	VR2 78L09
CR2 MPN3404	VR3 78S09CV
CR3 <i>H5M52800</i>	VR4 78L09
CR4 MPN3404	F1 TOKO 1547
CR5 MPN3404	F2 TOKO 1354
CR6 1N4000 type	F3 TOKO 2537
CR7 1N4000 type	F4 TOKO 2537
CR8 1N914 or 1N4148 (ORANGE GLASS BODY)	Y1 Crystal 101.000 MHz 5 th Overtone HC 18/U
CR9 MPN3404	K1 G5V-2
CR10 MPN3404	K2 <i>G6Y</i>

HARDWARE KIT

(2) 1000pF Capacitor	(4) Adhesive Backed Rubber Feet
(1) 100µF Capacitor	#22 Teflon Wire 4"
(2) LED, RED	#18 Teflon Wire 4"
(2) Switch SPST	RG/188U Mini Coax 6"
(2) BNC Female UG1094/U Connectors	(1) Machined Die cast enclosure
(3) RCA Jacks - Control, Aux., Power	(1) 3/32" Allen key wrench
(2) Type "N" Connector and hardware	(1) Machined Heatsink 8 1/2"
(2) 6-32 x 3/8" Machine Screws for Power Module	(1) Label Set
(13) 4-40 x 5/8" Cap Screws	(1) Thermal Grease
(26) 4-40 Nuts	(4) Cover screws
(1) Brass angle	

Miscellaneous Parts: (1) RF Power Module IC5, M57745 (1) Printed Circuit Board

MPN3404 diode

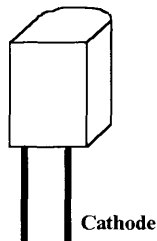

MPS5179 Transistor

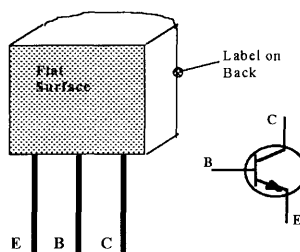

78L09 Regulator

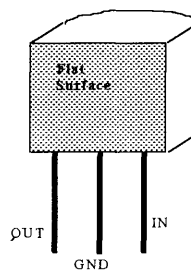

2N5179 Transistor Metal Can

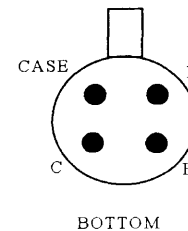

PTC-50 Thermistor installation

Although installation of the PTC-50 thermistor may be done at any time, it is most convenient to do it before the final wiring is completed. Because it is important to determine if the oscillator circuit is 100% functional before installing the thermistor, some double work is required. You may complete the assembly of the transverter then install the thermistor or install it now. We at the Down East Microwave Inc. Factory install the thermistor after complete assembly and the oscillator has aged for 24 hours. (a burn in period) You may do the same but it is not required. Just expect to see some frequency drift for the first 24 hours of operation.

To install the thermistor correctly, remove the PCB from the enclosure. To do this, un-solder the PTT wire, and the 3", #18 wire from their RCA jacks. Then remove both the LO and the Power switches from the enclosure. Next remove the 2, 4-40 nuts and the PCB should come out of the enclosure.

Locate the thermistor and remove one of the attached wires with some heat from a solder iron. Then review the diagram below. Note that the thermistor is attached by solder to the crystal. Start by tinning the case of the crystal. Heat the case with an iron and flow some solder on it. Then while still heating the case, place the side of the thermistor without the wire in the molten pool of solder and remove the iron. Now before allowing the crystal / thermistor assembly to cool, note where the crystal and Q1 almost touch Heat the case of Q1 with your iron and flow a bead of solder so that it attaches to the crystal. Allow to cool and then inspect for a good solid connection. If in doubt, re-flow and add more solder. If the second local oscillator is used, a thermistor may be installed to that crystal also but if the second oscillator is used for satellite operation, the frequency stability may not be that important because of the Doppler shift.

You may now re-install the PC board in the enclosure and continue the assembly on page 11. Only now include the attachment of the thermistor wire to the center post of the LO switch. If the second thermistor is installed, the wire may also be attached to the center of the LO switch of in the extra hole on the PC board marked with an + by the LO2 connection. Connecting the thermistor wire to the center post will always keep both oscillators in "Hot standby" as long as the transverter is on.

Some important notes. The crystal needs to be attached to the Q1 or Q3 transistor for 2 reasons. One is to provide a DC path for the thermistor through the case ground of the transistor and the other is to maintain a constant temperature of the oscillator transistor. If the solder bead is not attached to the transistor, the thermistor will not heat up!

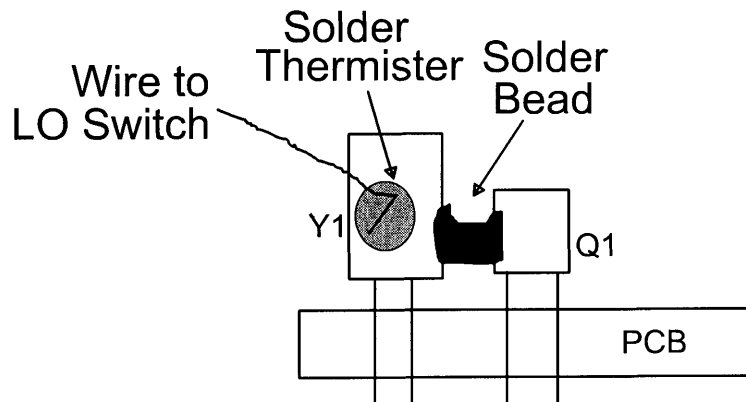

Proper Attachment of Thermistor to Crystal

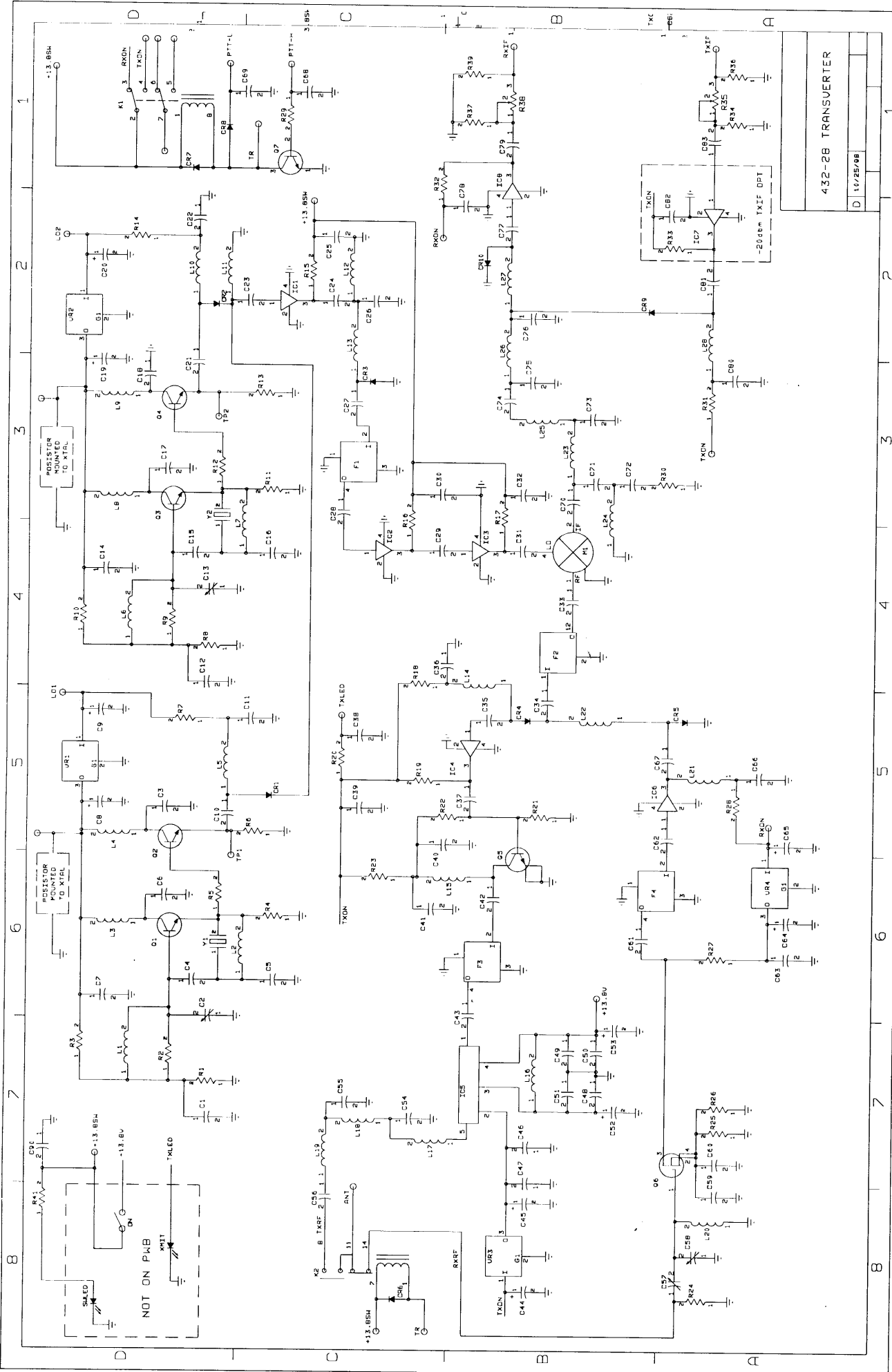

432-28 TRANSVERTER

D 10/25/98

432-28
BOTTOM ASSEMBLY
10/25/98

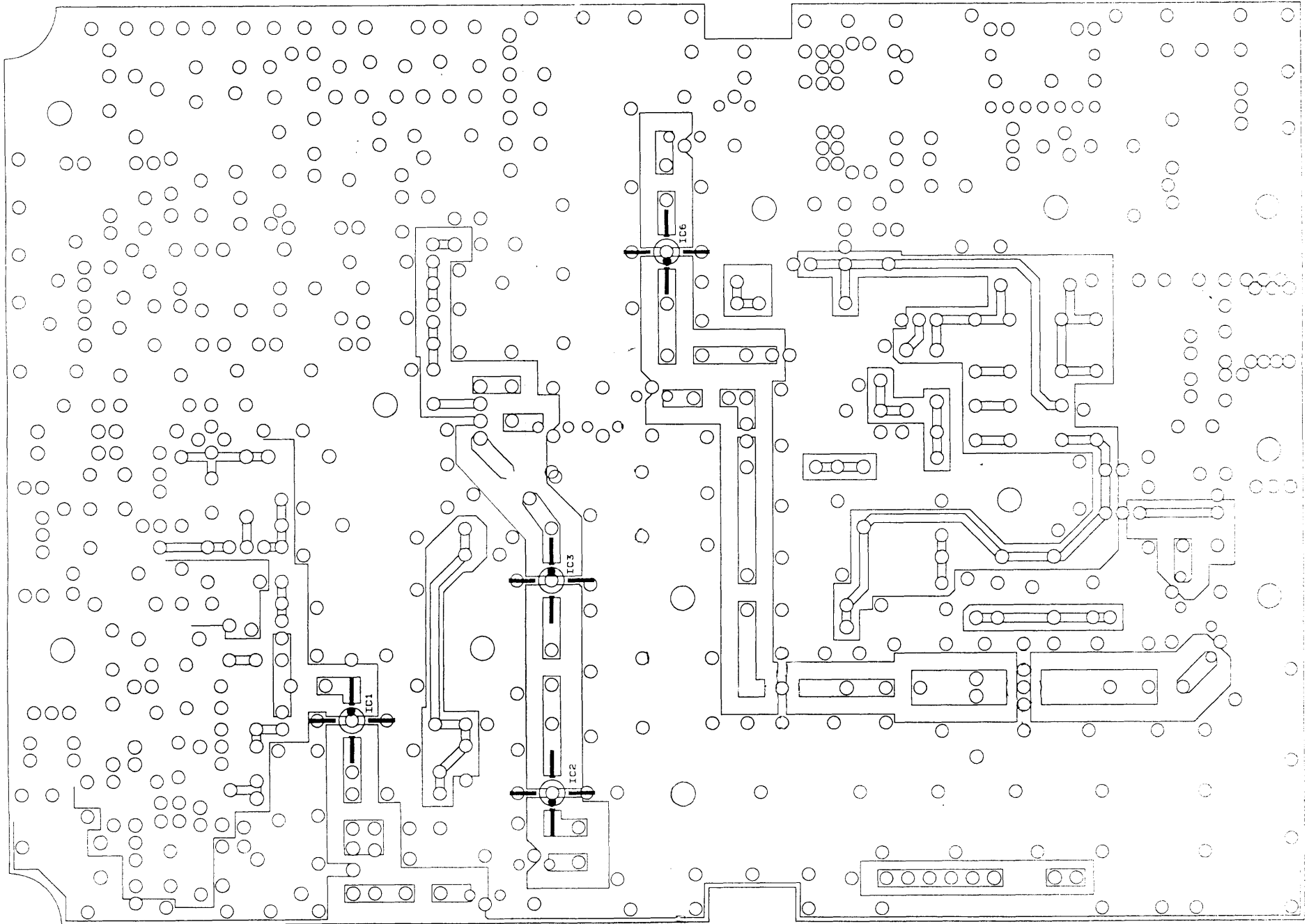

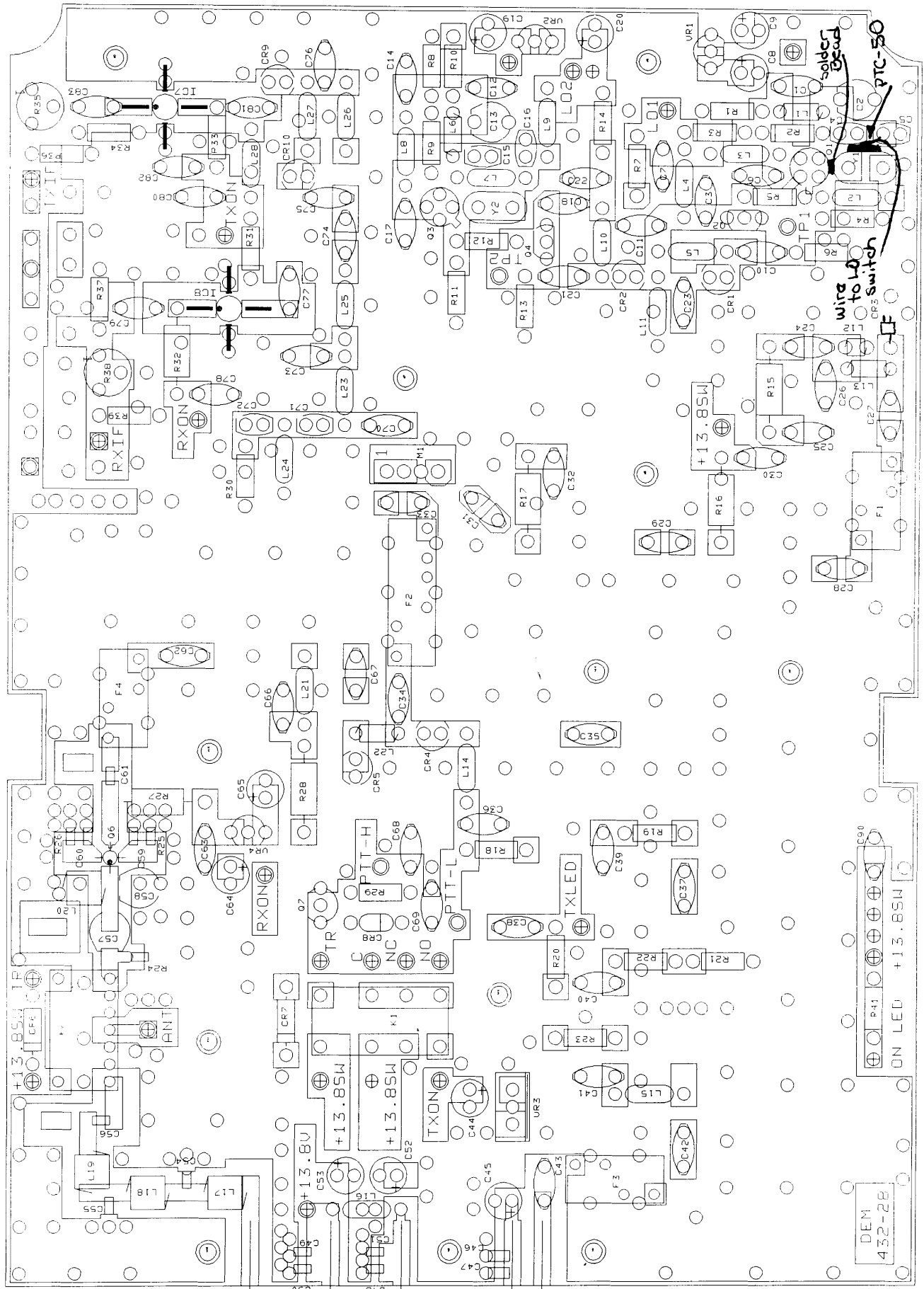

IC5

DEM
432-28

ON LED +13.85V

wire to LED
switch

solder
bead

PTC-50