

# IC-RM2

## COMPUTERIZED REMOTE CONTROLLER

### INSTRUCTION MANUAL

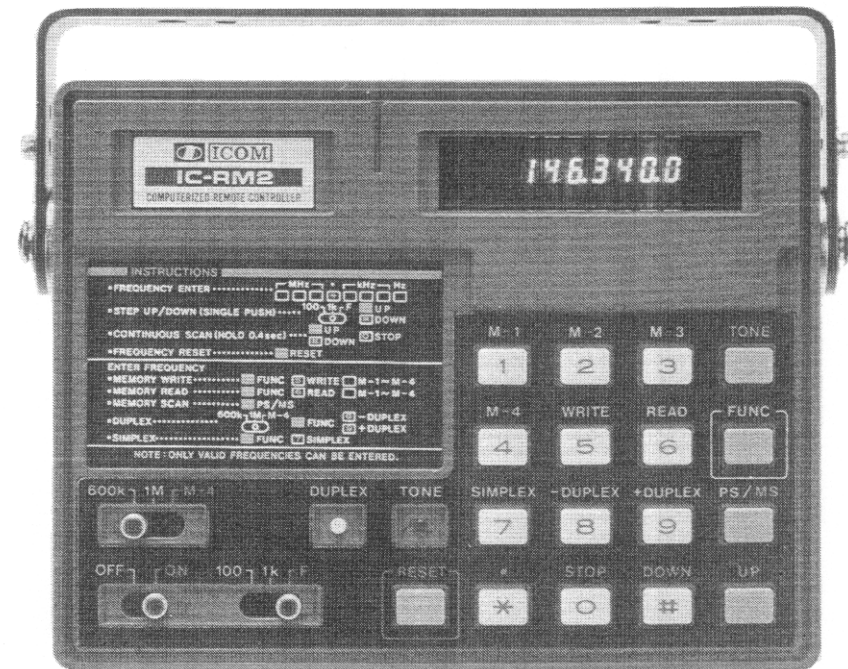

## SECTION 1 SPECIFICATIONS

Frequency Range	HF	1.8000 ~ 1.9999MHz	
		3.5000 ~ 3.9999MHz	
		7.0000 ~ 7.4999MHz	
		14.0000 ~ 14.9999MHz	
		15.0000 ~ 15.1999MHz	
		21.0000 ~ 21.4999MHz	
		28.0000 ~ 28.9999MHz	
		29.0000 ~ 29.9999MHz	
			VHF
		146.0000 ~ 147.9999MHz	
Number of Semi-conductors	Transistor		10
	IC		15
	Diode		23
	Luminescent Display Tube		1
Operationable Temperature		0°C - 60°C (32°F - 140°F)	
Power Requirement		13.8V DC, 120mA max., negative ground	
Memory Power Requirement		9 - 16V DC, 25mA	
		(See page 10 for details)	
Dimensions		30.5mm (H) x 142mm (W) x 112mm (D)	
Weight		Approx. 650g.	

## SECTION 2 FEATURES

*The IC-RM2 computer controller is designed for use with the IC-211, IC-245 and the IC-701.*

*This unit can control either the HF bands or the 2-meter band by the use of a CPU.*

- \* An automatic switching circuit allows use with both HF bands and the 2-meter band.*
- \* Frequency setting can be made simply by pushing the appropriate keys.*
- \* The set frequencies are checked by the CPU to determine if they are within the amateur bands. If not, they are automatically cancelled.*
- \* Four memory frequencies allow easy writing and reading of desired programmed frequencies. In addition, these four frequencies can be easily ready by One-Step scanning.*
- \* With the programmable scan, you can scan within a desired frequency range only.*
- \* Split frequency operation is possible.*
- \* UP/DOWN scan capability with selectable frequency steps.*
- \* Easy frequency reading by use of a clear and bright luminescent display tube.*
- \* Duplex operation is available for both  $\pm 600\text{KHz}$  and  $\pm 1\text{MHz}$  separation. Odd splits can be programmed using memory 4.*
- \* Built-in Touch Tone encoder.*

## SECTION 3 INSTALLATION

BE SURE TO READ THE FOLLOWING INSTRUCTIONS BEFORE USE.

### 3 - 1 UNPACKING

Carefully remove your controller from the packing carton and examine it for signs of shipping damage. Should any be apparent, notify the delivering carrier or dealer immediately, stating the full extent of the damage. It is recommended you keep the shipping cartons. In the event storage, moving, or reshipment becomes necessary they will be handy. Accessory cables, plugs, etc., are packed with the controller. Make sure you have not overlooked anything.

#### Accessories

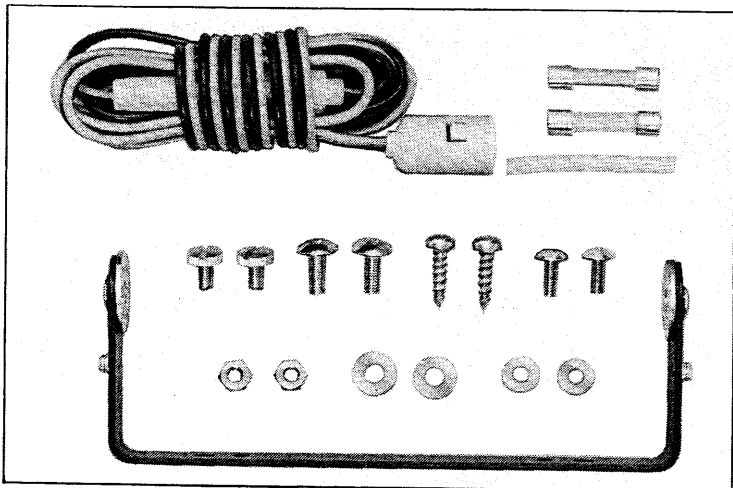

#### How to set the stand

(A)

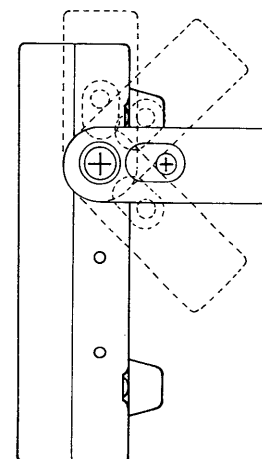
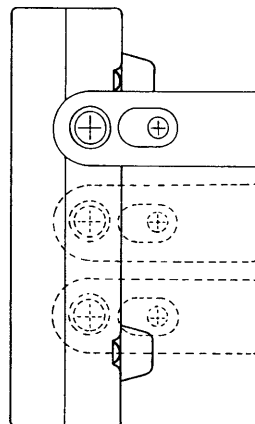

(B)

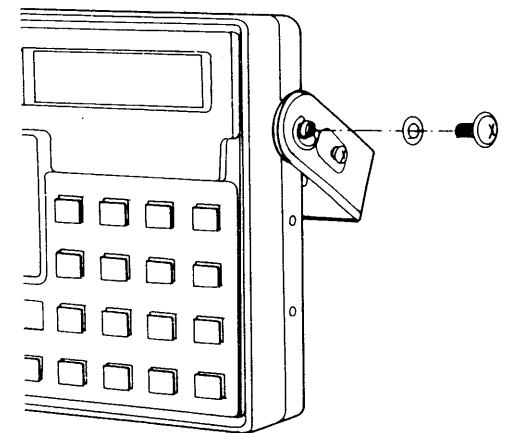

### 3-3 HOW TO CHANGE THE DIRECTION OF THE CABLE

When you would like to change the direction of the cable, remove the two screws for the cable holder, move the cable to the desired angle, and reattach the holder with the two screws.

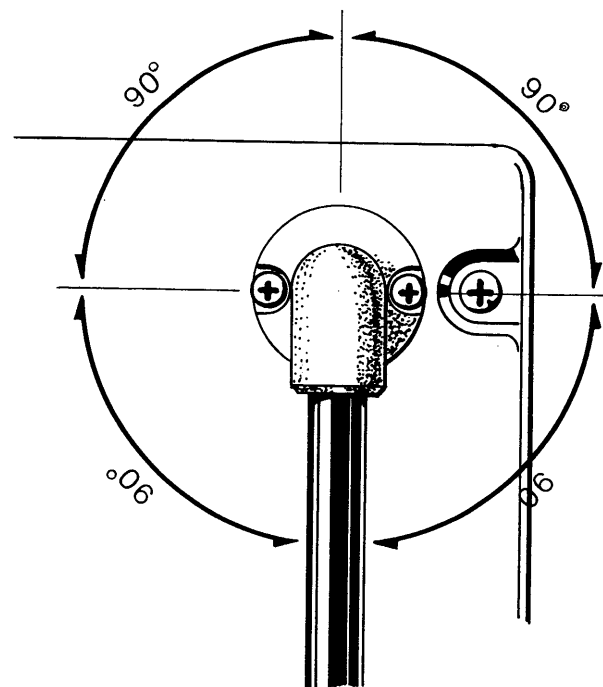

**CAUTION:** The IC-RM2 is compact, and is designed as an anti-vibration stable unit. The functions provided, such as UP/DOWN keys, memory channels, etc., are very handy for mobile use. Since the layout of the controls on the front panel is entirely new and different from any previous mobile radios, it is absolutely necessary that the vehicle driver completely understand and familiarize himself with the operation of the unit before using it while driving to ensure safe mobile operation.

# SECTION 4 OPERATING CONTROLS

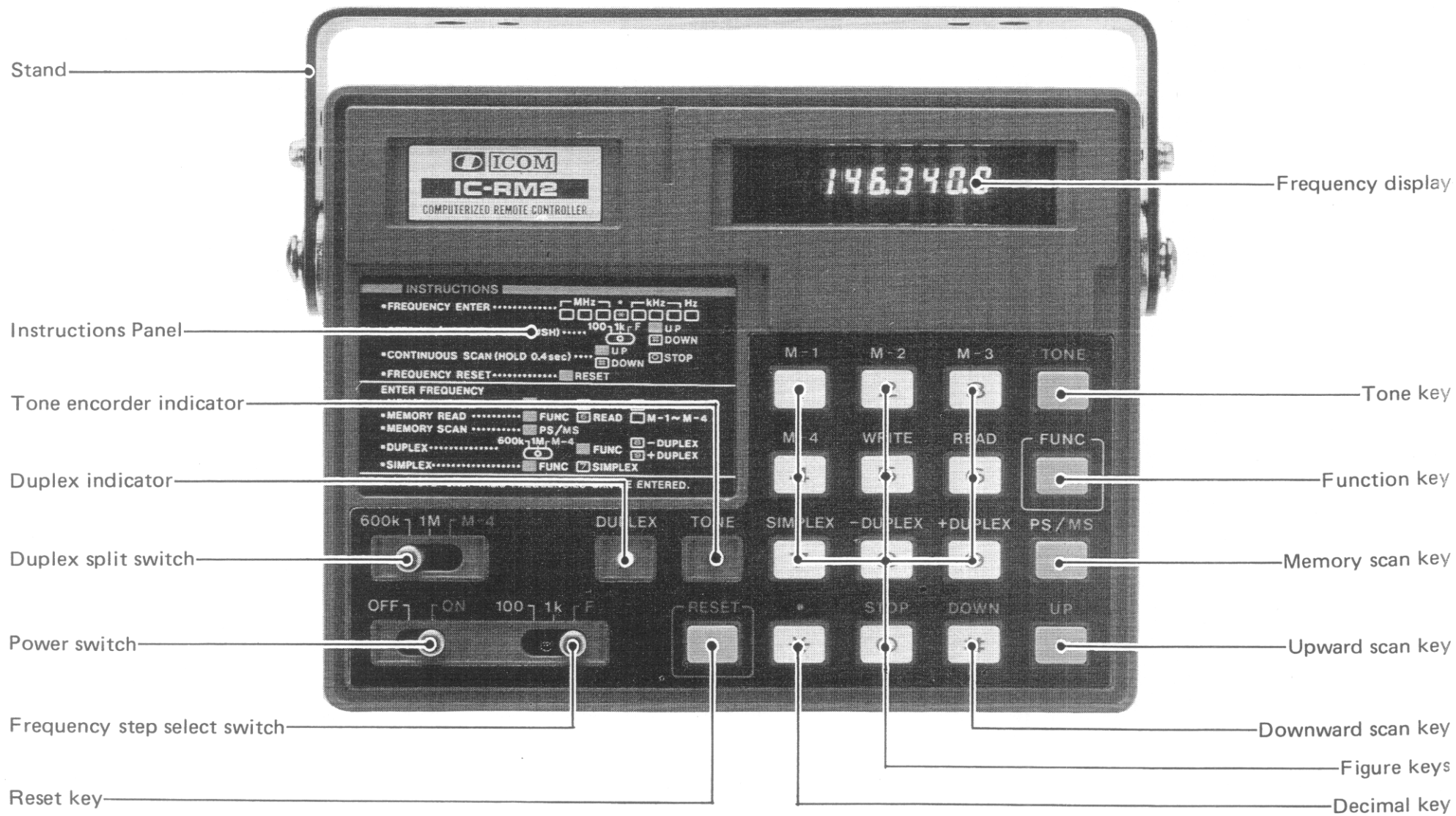



Turns the power ON in the ON position and locks the Tuning Control of the connected unit. Set this switch to the OFF position to unlock the Tuning Control.

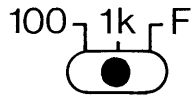

Sets the scanning step pitch: 100Hz steps at the "100" position, 1KHz steps at the "1K" position, and 15KHz steps at the "F" position.



Sets the duplex frequencies. The 600K position provides 600KHz T/R separation, 1M gives 1MHz separation, and M-4 sets the programmed frequency in M-4 as the transmitting frequency.



These are DUPLEX and TONE encoder indicators which illuminate then in the duplex mode or when the tone encoder is engaged.

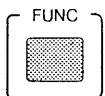

Changes the function of the dual function keys to the memory mode or duplex mode.

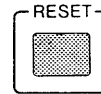

Clears the frequency which has been partially set on the keyboard, and resets the previous frequency then it is ready for another frequency setting to be entered on the keys.

M-1



Sets the figure 1 or writes/reads Memory Channel 1 (M-1).

M-2



Sets the figure 2 or writes/reads Memory Channel 2 (M-2).

M-3



Sets the figure 3 or writes/reads Memory Channel 3 (M-3).

M-4



Sets the figure 4 or writes/reads Memory Channel 4 (M-4).

WRITE



Sets the figure 5 or sets the memory-write function for M-1 through M-4.

READ



Sets the figure 6 or sets the memory-read function for M-1 through M-4.

SIMPLEX



Sets the figure 7 or resets to simplex operation.

-DUPLEX



Sets the figure 8 or sets to -DUPLEX operation (where transmitting frequency is below the receiving frequency).

+DUPLEX



Sets the figure 9 or sets to +DUPLEX operation (transmitting frequency is above the receiving frequency).

STOP



Sets the figure 0 or stops the scan.



Sets and illuminates the decimal points at the MHz and KHz orders.

STONE



Engages and disengages the tone encoder.

PS/MS



Provides one-step scan of the programmed memory frequencies or starts the scan between two desired frequencies.

UP



Shifts the operating frequency up by one step, or continuously by depressing this key for more than 0.4 seconds.

DOWN



Shifts the operating frequency down by one step, or continuously by depressing this key down for more than 0.4 seconds.

## SECTION 5 OPERATING INSTRUCTIONS

### 5 - 1 HOW TO USE WITH THE IC-701 HF TRANSCEIVER

#### 5 - 1 - 1 CONNECTING THE CONTROLLER

Make sure that both your transceiver and the IC-RM2 are turned OFF and that the transceiver is not set in the transmit mode by the T/R switch or the microphone PTT switch.

Connect the IC-RM2 cable to the ACC socket on the rear panel of the transceiver.

Set the band switch on the IC-701 to the EXT position.

Set the Fast Tuning circuit of the IC-701 to OFF.

#### 5 - 1 - 2 BASIC OPERATION

The control section of the IC-RM2 consists of 17 keys and 3 slide switches. Most of the keys have dual functions.

The FUNCTION key provides duplex and memory operations.

The RESET key recalls the frequency previously set and sets up the IC-RM2 for another frequency entry or other operation.

The POWER switch is to turn the IC-RM2 ON or OFF. In the OFF position, the frequency is controlled with the Tuning knob of the transceiver. In the ON position the transceiver Tuning knob is locked and the frequency setting

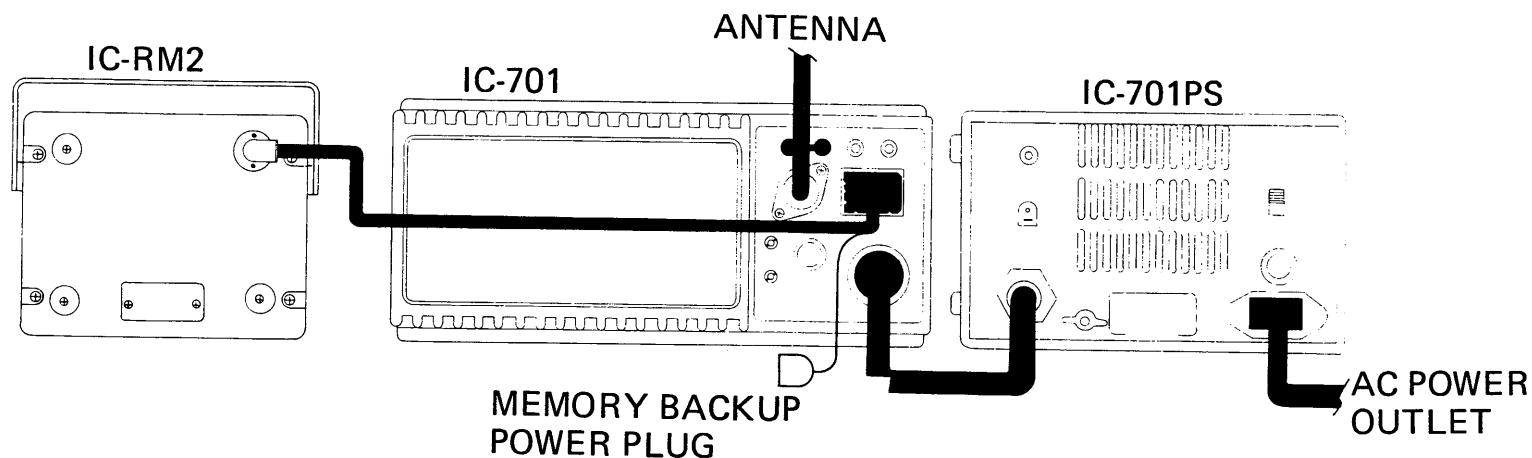

can be made only by the IC-RM2. If the controller is modified as described in 5 - 2 - 12 (on page 23) the frequency setting can be set by both the controller and the Tuning knob of the transceiver.

The FREQUENCY STEP SELECT switch selects the frequency steps: 100Hz, 1KHz, 15KHz.

The DUPLEX split switch is for setting the separation of the transmitting frequency.

The TONE key is for turning ON the tone circuit.

### 5 - 1 - 3 MEMORY BACKUP

To keep the programmed memories and other memories when the power switch of the transceiver is turned OFF, connect an AC adapter or other DC power source to the memory backup power plug, as shown in the figure.

The required voltage is 9~15V DC and the current drain is approximately 25mA.

### 5 - 1 - 4 PRE OPERATION

Switch the Power of the IC-701 ON.

Switch the Power of the IC-RM2 ON.

Check if "0" is displayed on the 100Hz digit of the IC-RM2. If nothing is shown on the frequency display of the IC-RM2, refer to the section on TROUBLE SHOOTING and follow the instructions.

Check if the frequency display of the IC-701 shows 28.000.0MHz. (make sure the band switch is in the EXT position)

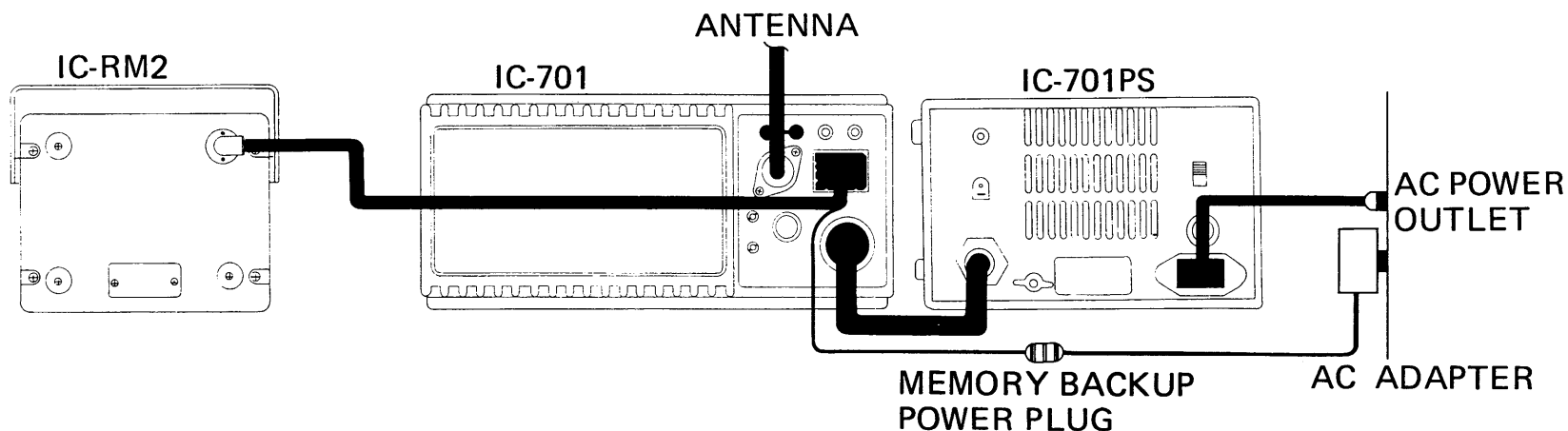

## 5 - 2 OPERATION WITH THE IC-701

### 5 - 2 - 1 INITIAL FREQUENCY SETTING

EXAMPLE: Set 14.2680MHz

When the last figure (the 100Hz digit) is entered by pushing the key for "0", the rotary relay in the IC-701 band switch operates (a clicking sound will be heard), and the IC-701 will temporarily show 14.000.0.

\* Approximately 1.5 seconds after entering the last figure, the IC-701 display changes from 14.000.0 to the desired frequency of 14.268.0, and a beep sound from the IC-RM2 will be heard.

As the band setting for the IC-701 is made by a rotary relay, it takes a maximum of 1.5 seconds to change from one band to another. For this reason, the IC-RM2 is designed so that the signals to set the last four digits (100KHz and below) are sent to the IC-701 approximately 1.5 seconds after entering the last digit, which is also the beginning of the rotary relay function to switch the band.

\* Pressing any other key during the 1.5 second setting time may cause malfunctions. If this happens, push "RESET" and again set the desired frequency.

KEY	Display of IC-RM2	Display of IC-701
Before entering key	0	28.000.0
M-1 1	1	28.000.0
M-4 4	14	28.000.0
.	14.	28.000.0
M-2 2	14.2	28.000.0
READ 6	14.26	28.000.0
-DUPLEX 8	14.268.	28.000.0
STOP 0	14.268.0	14.000.0

The rotary relay of IC-701 turns to 14MHz band, and after 1.5 seconds, the IC-RM2 beeps and the desire frequency enters the IC-701.

14.268.0	14.268.0
----------	----------

NOTE: Frequency setting cannot be made when in the transmit mode or scan mode.

## 5 - 2 - 2 CHANGING FREQUENCIES ON THE SAME BAND

When a frequency is set in the same band, resetting the 10MHz and 1MHz digits is not necessary. There is no 1.5 second delay before the frequency set is completed.

EXAMPLE: Set 14.1800MHz when the present operating frequency is 14.2680MHz.

KEY	Display of IC-RM2	Display of IC-701
Before entering key	14.2680	14.2680
$\cdot$ *	14. .	14.2680
M-1 1	14.1 .	14.2680
-DUPLEX 8	14.18 .	14.2680
STOP 0	14.180.	14.2680
STOP 0	14.1800	14.1800

The IC-RM2 beeps immediately and the IC-701's frequency changes to the desired frequency.

If you wish to change the frequency to a different band, follow the same procedure as described in 5 - 2 - 1 on page 11.

### 5 - 2 - 3 IF AN INCORRECT FREQUENCY (OUT OF THE RATED RANGE) IS ENTERED

#### (A) INCORRECT MHz DIGIT FREQUENCY

When a frequency outside the ranges below is programmed, the display shows the previously set frequency after the last digit is entered. (If the setting is the first one set after the power is turned ON, "0" is shown.)

#### OPERATIONABLE FREQUENCY RANGE

1.8MHz band	1.8000 ~ 1.9999MHz
3.5MHz band	3.5000 ~ 3.9999MHz
7 MHz band	7.0000 ~ 7.4999MHz
14 MHz band	14.0000 ~ 14.9999MHz
	15.0000 ~ 15.1999MHz
21 MHz band	21.0000 ~ 21.4999MHz
28 MHz band	28.0000 ~ 28.9999MHz
	29.0000 ~ 29.9999MHz

EXAMPLE: When 22.2680MHz is entered:

KEY	Display of IC-RM2	Display of IC-701
Before entering key	21.180.0	21.180.0
M-2 2	2	21.180.0
M-2 2	22	21.180.0
*	22.	21.180.0
M-2 2	22.2	21.180.0
READ 6	22.26	21.180.0
-DUPLX 8	22.268	21.180.0
STOP 0	21.180.0	21.180.0

The IC-701 display does not change frequency. If no frequency was entered after the IC-RM2 was switched ON, the display of the IC-RM2 returns to 0 and the IC-701 display remains 20.000.0.

### 5 - 2 - 3 IF AN INCORRECT FREQUENCY (OUT OF THE RATED RANGE) IS ENTERED

#### (B) INCORRECT FREQUENCY DIGIT BELOW 100KHz

When correct 10MHz and 1MHz digits are entered but the digits for 100KHz and below are out of the range, the set frequency is corrected as shown below.

Keyed frequency	Corrected frequency
1.0000 ~ 1.7999MHz	1.8000MHz
3.0000 ~ 3.4999MHz	3.5000MHz
7.5000 ~ 7.9999MHz	7.0000MHz
15.2000 ~ 15.9999MHz	15.0000MHz
21.5000 ~ 21.9999MHz	21.0000MHz

EXAMPLE: When 7.5678MHz is entered:



KEY	Display of IC-RM2	Display of IC-701
Before entering key	21.180.0	21.180.0
SIMPLEX 7	7	21.180.0
.	7.	21.180.0
* WRITE 5	7.5	21.180.0
READ 6	7.56	21.180.0
SIMPLEX 7	7.567	21.180.0
-DUPLEX 8	7.000.0	7.000.0

The rotary relay of the IC-701 turns to the 7MHz band, and after 1.5 seconds, the IC-RM2 beeps and the corrected frequency enters the IC-701. If you entered a frequency in the same band, after the 100Hz digit key is pushed, the IC-RM2 beeps immediately and the corrected frequency enters the IC-701.

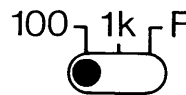

### 5 - 2 - 4 ONE STEP INCREASE/DECREASE

EXAMPLE: 100Hz step increase/decrease:

 Set the FREQUENCY STEP switch to the "100" position.

KEY	Display of IC-RM2	Display of IC-701
Before entering key	21.180.0	21.180.0
	21.180.1	21.180.1
	21.180.2	21.180.2



Pushing the  key increases the frequency in 100Hz steps.

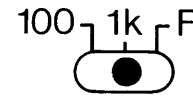

KEY	Display of IC-RM2	Display of IC-701
Before entering key	21.180.2	21.180.2
	21.180.1	21.180.1
	21.180.0	21.180.0

Pushing the  key decreases the frequency in 100Hz steps.

### EXAMPLE 2: 1KHz step increase/decrease

 Set the FREQUENCY STEP switch to the "1K" position.

KEY	Display of IC-RM2	Display of IC-701
Before entering key	21.180.2	21.180.2
	21.179.2	21.179.2
	21.178.2	21.178.2



Pushing  or  increases or decreases the frequency in 1KHz steps.

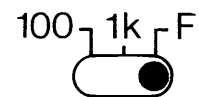



### EXAMPLE 3: 15KHz step increase/decrease

 Set the FREQUENCY STEP switch to the "F" position.

The frequency increases/decreases in 15KHz steps.

### 5 - 2 - 5 CONTINUOUS SCANNING

Depress the  key or  key for more than 0.4 seconds and the frequency is now in the scan mode and continuously shifts upward or downward. When the operating frequency reaches the highest or lowest edge of the operating frequency ranges (shown on page 13), it jumps to the opposite edge of the range and keeps scanning in the same direction.

Stop the scan by pushing the  key. While scanning, none of the keys function except the  key. When the  key is pushed twice, the display frequency is changed to "0". However, the actual operating frequency is not changed and can be reset on the display by keying .

Set the FREQUENCY STEP switch to the desired step position.

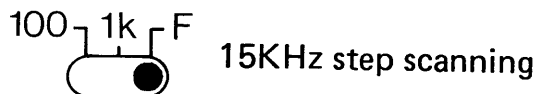
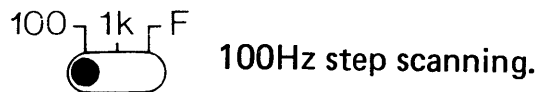

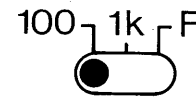

NOTE: During scanning all keys except the  key do not function. If you desire another function, you should push the  key, then push the desired other key.

EXAMPLE: 100Hz step scanning upward.



Set the FREQUENCY STEP switch to the "100" position.

KEY	Display of IC-RM2	Display of IC-701
Before entering key	21.180.0	21.180.0
	21.180.1	21.180.1
Hold for more than 0.4 seconds	21.180.2	21.180.2
	21.180.3	21.180.3
	21.180.4	21.180.4

The frequency will continuously scan in 100Hz steps until you push the  key.

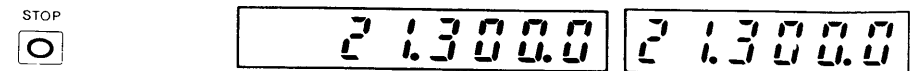

When the  key is pushed twice by mistake.

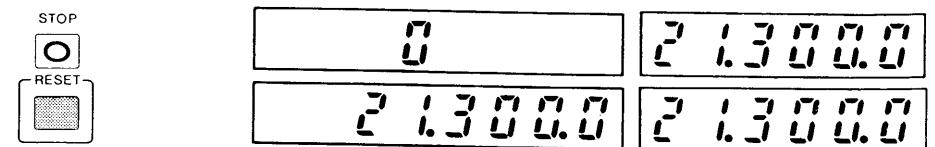



## 5 - 2 - 6 WRITING FREQUENCIES INTO THE MEMORY CHANNELS.

Set a desired frequency on the display by keying, scanning, etc. If the desired frequency is 7.050.0MHz: See Example 1. This function programs 7.050.0MHz into Memory Channel 1. (M-1)

Set a desired frequency on the display by keying, scanning, etc. If the desired frequency is 3.510.0MHz: See Example 2. Now 3.510.0MHz is programmed into Memory Channel 2. (M-2)



Program two more frequencies you need in Memory Channels 3 and 4 in the same manner (any frequencies within the operation ranges).

### EXAMPLE 1: MEMORY WRITING into M-1.

KEY	Display of IC-RM2	Display of IC-701
Before entering key	7.050.0	7.050.0
	7.050.0	7.050.0
	7.050.0	7.050.0
	7.050.0	7.050.0

The frequency 7.050.0 is written into M-1.

### EXAMPLE 2: MEMORY WRITING into M-2.

KEY	Display of IC-RM2	Display of IC-701
Before entering key	3.5 10.0	3.5 10.0
	3.5 10.0	3.5 10.0
	3.5 10.0	3.5 10.0
	3.5 10.0	3.5 10.0

The frequency 3.5 10.0 is written into M-2.

You can write any frequency into M-1 ~ M-4 using the same procedure.

## 5 - 2 - 7 READING THE PROGRAMMED MEMORY CHANNELS

Follow the key operations below to recall the frequency programmed into Memory Channel 1.

The programmed frequency in Memory Channel 1. 7.050.0, is displayed and, if the frequency set before recalling Memory Channel 1 was not in the 7MHz band, 1.5 seconds later, the IC-701 display shows 7.050.0MHz and a beep will be heard from the IC-RM2.

The same procedure recalls the programmed frequencies in the other Memory Channels.

**EXAMPLE:** When programmed frequencies in the Memory Channels are as follows:

M-1	7.050.0
M-2	3.5 10.0
M-3	3.8 18.0

### 1: Reading M1

KEY	Display of IC-RM2	Display of IC-701
Before entering key	14.268.0	14.268.0
	14.268.0	14.268.0

### KEY

READ  
6

M-1  
1

Display of IC-RM2

Display of IC-701

14.268.0	14.268.0
7.050.0	7.000.0

The rotary relay of the IC-701 turns to the 7MHz band and after 1.5 seconds, the IC-RM2 beeps and M-1's frequency enters the IC-701.

7.050.0	7.050.0
---------	---------

### 2: Reading M2

FUNC  

READ  
6

M-2  
2

After 1.5 seconds

7.050.0	7.050.0
7.050.0	7.050.0
3.5 10.0	3.500.0
3.5 10.0	3.5 10.0

### 3: Reading M-3



FUNC  



READ  
6



M-3  
3

3.5 10.0	3.5 10.0
3.5 10.0	3.5 10.0
3.8 18.0	3.8 18.0

## 5 - 2 - 8 MEMORY SCANNING









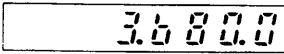
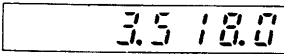
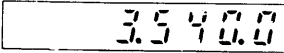
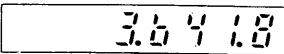

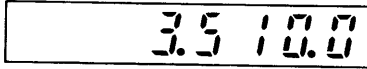
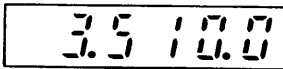
One-Step Scan of the programmed frequencies can be accomplished by pushing the  key. But the scan can be made only among the Memory Channels in which the programmed frequencies are in the same band set when the  key is pushed.

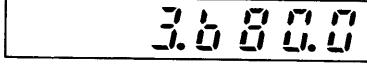
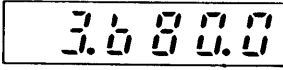
The scanning order of the recalled channels is from Memory Channel 1 to 4. However, the channels without programmed frequencies and channels with programmed frequencies in other operating frequency ranges are skipped when the  key is pushed.

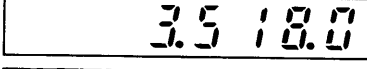
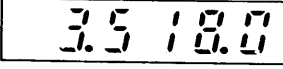

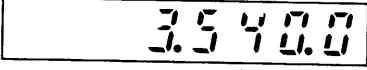
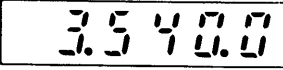
Continuous scan among the Memory Channels can be accomplished by depressing  for more than 0.4 seconds. This scan is made only among the Memory Channels with the frequencies in the same band as the set frequency at the time the  key is pushed. To stop the scan, push the  key.

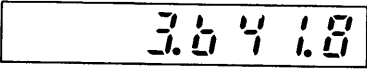
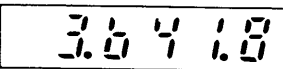

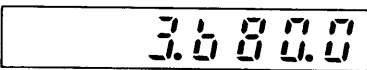
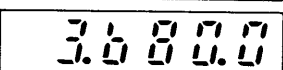

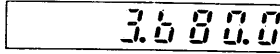
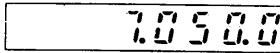

**EXAMPLE 1:** When programmed frequencies in memories are as follows:

M-1	
M-2	
M-3	
M-4	

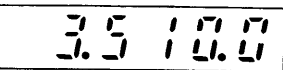
KEY	Display of IC-RM2	Display of IC-701
Before entering key		
		
		
		
		
		

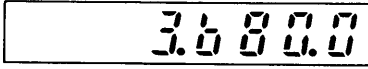
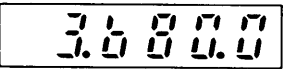
**EXAMPLE 2:** When programmed frequencies in memories are as follows:

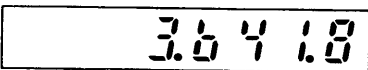
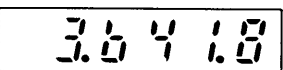
M-1	
M-2	
M-3	NO PROGRAM
M-4	

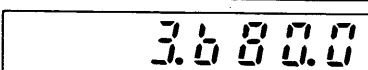
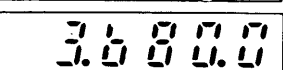
Before entering key		
		
		
		



## 5 - 2 - 9 SPECIFIED RANGE SCANNING

The IC-RM2 can be programmed using M-4 as a reference point, to scan from the entered frequency up or down to memory M-4 and back to the entered frequency.

This allows you to scan a set portion of the band without having to scan the entire band.

**EXAMPLE:** Scanning between 3.510.0MHz and 3.600.0 MHz.

1. Enter the lower edge or higher edge frequency into M-4 memory.

KEY	Display of IC-RM2	Display of IC-701
Before entering key	3.5 10.0	3.5 10.0
	3.5 10.0	3.5 10.0
 5	3.5 10.0	3.5 10.0
 4	3.5 10.0	3.5 10.0

2. Enter another edge frequency on the display.

Before entering key	3.5 10.0	3.5 10.0
	3. .	3.5 10.0

### KEY



Display of IC-RM2

Display of IC-701

3.6 .	3.5 10.0
3.60 .	3.5 10.0
3.600.	3.5 10.0
3.600.0	3.600.0

3. Set the FREQUENCY STEP switch to the desired step position.

If you set to:

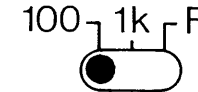

Hold more than 0.4 seconds

The frequency scans to the lower edge and returns to the higher edge in the desired steps until you push the  key.



3.600.0	3.600.0
3.600.0	3.600.0
3.599.9	3.599.9
3.599.8	3.599.8
↓	↓
3.5 10.1	3.5 10.1
3.5 10.0	3.5 10.0
3.5 10.1	3.5 10.1

## 5-2-10 SPLIT FREQUENCY OPERATION

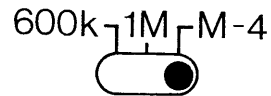

1. Set the DUPLEX SPLIT SELECT switch to the M-4 position.



2. Enter desired transmitting frequency into M-4 memory.
3. Enter desired receiving frequency on the display by keying, scanning, etc.

4. Push  key and then either  or .

This completes the setting, and the M-4 frequency appears during transmit, and the other frequency previously set is displayed during receive.

- \* To cancel this function, push  and then .

NOTE: If the setting is cancelled after setting for Split frequency operation without putting the IC-701 at least once in the transmit mode, the display frequency may be changed. To avoid this problem, make sure to set the IC-701 in the transmit mode even once before cancelling the split frequency set.

### KEY



WRITE

5

M-4

4

Display of  
IC-RM2

7.235.0

7.235.0

7.235.0

Display of  
IC-701

7.235.0

7.235.0

7.235.0

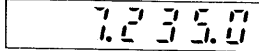
The frequency  is written into M-4.



STOP



+DUPLEX

9

STOP



STOP



-DUPLEX

8

7. .

7.0 .

7.09 .

7.090.

7.090.0

7.090.0

7.090.0

7.235.0

7.235.0

7.235.0

7.235.0

7.090.0

7.090.0

7.090.0

DUPLEX



The DUPLEX INDICATOR is lit and shows that you are ready for split frequency operation.

T/R switch or PTT switch changes to TRANSMIT.



7.235.0

7.235.0

## 5 - 2 - 11 WHEN THE IC-RM2 IS TURNED OFF THEN ON AGAIN

While the IC-RM2 is in operation, the Tuning Control of the IC-701 is locked and the operating frequency is not controlled by rotating the Tuning Control. To tune with the Tuning Control, the IC-RM2 must be turned OFF. When the IC-RM2 is turned OFF, the band setting of the IC-701 is changed to the 28MHz band (if the IC-RM2 is set for the 28MHz band, the band stays on 28MHz).

Turn the Band Select switch of the IC-701 to the desired band instead of setting at the EXT position. When the IC-RM2 is turned ON again, only the display for the band is shown on the IC-RM2. The frequency setting for a frequency on the band can be made only by setting figures for 100KHz and below. Pushing "RESET" shows the previously set frequency on the IC-RM2. However, the frequency of the IC-701 is not set at this frequency but at 7.000.0MHz, which is different from the IC-RM2 frequency. Therefore, the frequency which appears on the IC-RM2 display by pushing "RESET" is for checking at which frequency the IC-RM2 was previously set.

KEY	Display of IC-RM2	Display of IC-701
Using IC-RM2	7.056.0	7.056.0
Power switch set to OFF		28.000.0
Using the IC-701 alone (band switches)		3.599.0
Band switch on IC-701 is set to EXT		28.000.0
Power switch is turned ON again	7 .	7.000.0
	7.056.0	7.000.0
	7.056.1	7.056.1
	7.056.0	7.056.0

You can return to the previous frequency. When the power switch of the IC-RM2 is turned OFF, the operating frequency of the IC-701 goes to 28.000.0MHz automatically. If you want to continue operation on the same band, using the IC-701's Tuning Control, you must modify the IC-RM2, as discribed in 5 - 2 - 12 on page 23.

## 5 - 2 - 12 MODIFYING THE IC-RM2 FOR DUAL CONTROL OPERATION

The following instructions should be used to modify the IC-RM2 so the IC-RM2 can be used to set the basic frequency, and the Tuning control on the IC-701 can be used also to control the frequency without having to turn OFF the IC-RM2.

1. Remove the bottom case of the IC-RM2.
2. Remove P2 from J2 on the PC board.

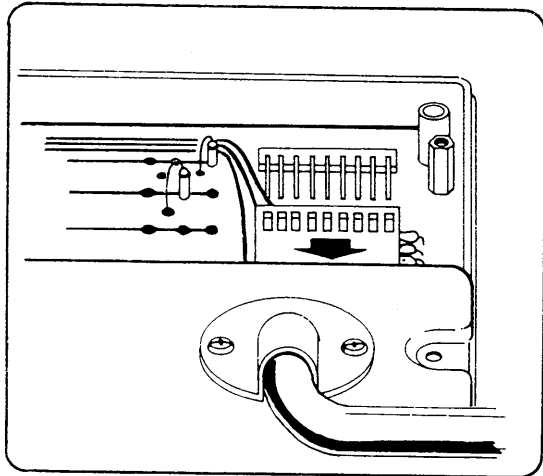

3. Remove the 7th contact pin of P2 from it's molded plastic housing.

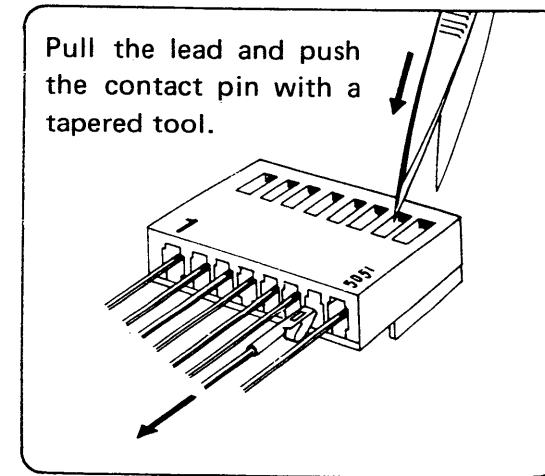

4. Cover the contact pin with the plastic tube included in the accessories to insulate the pin.

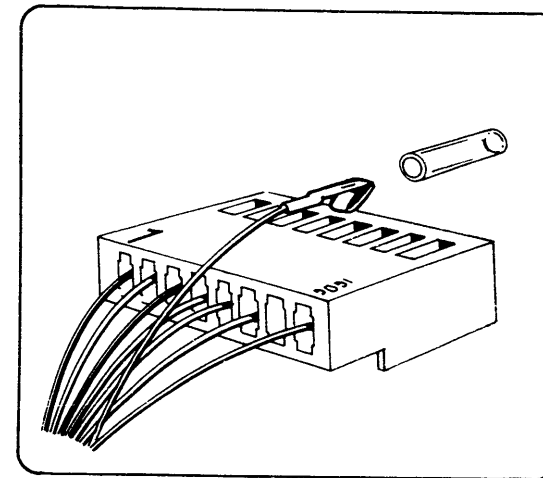

5. Reconnect P2 to J2 on the PC board.
6. Replace the bottom case.

## 5 - 2 - 13 DUAL CONTROL OPERATION

You can have DUAL CONTROL OPERATION by using an IC-RM2 that has been modified as in 5 - 2 - 12 described on page 23.

1. In this case the IC-701 Dial does not lock when the power switch of the IC-RM2 is turned ON. Thus you can tune the IC-701 by rotating the Tuning Control knob after setting a frequency with the IC-RM2.
2. Write the desired frequency on each band into M1 - M4 memories.

**EXAMPLE:** When the following frequencies are written into M1 - M4 memories.

M-1	
M-2	
M-3	
M-4	

KEY	Display of IC-RM2	Display of IC-701
Before entering key		
After 1.5 seconds		
After rotating the Tuning control knob of the IC-701 to tune around the set frequency.		

**CAUTION:** In this case, the display of the IC-RM2 does not show actual operating frequency.

If you want to return to the memorized frequency, read the memory again, or push the key and the key one time each.

Likewise, by reading other memories, you can perform the Dual Control Operation.

## 5 - 3 HOW TO USE WITH THE IC-211/IC-245 VHF TRANSCEIVER

### 5 - 3 - 1 CONNECTING THE CONTROLLER

Make sure that both your transceiver and the IC-RM2 are turned OFF and that the transceiver is not set in the transmit mode by the T/R switch or the microphone PTT switch.

Connect the IC-RM2 cable to the ACC socket on the rear panel of the transceiver.

Set the Fast Tuning circuit of the transceiver to OFF, Set the VFO switch of the IC-211 to A, B or SIM position, or the DUPLEX switch of the IC-245 to SIM position.

### 5 - 3 - 2 BASIC OPERATION

Same as for the IC-701.

Refer to 5 - 1 - 2 on page 9.

#### Connection of IC-RM2

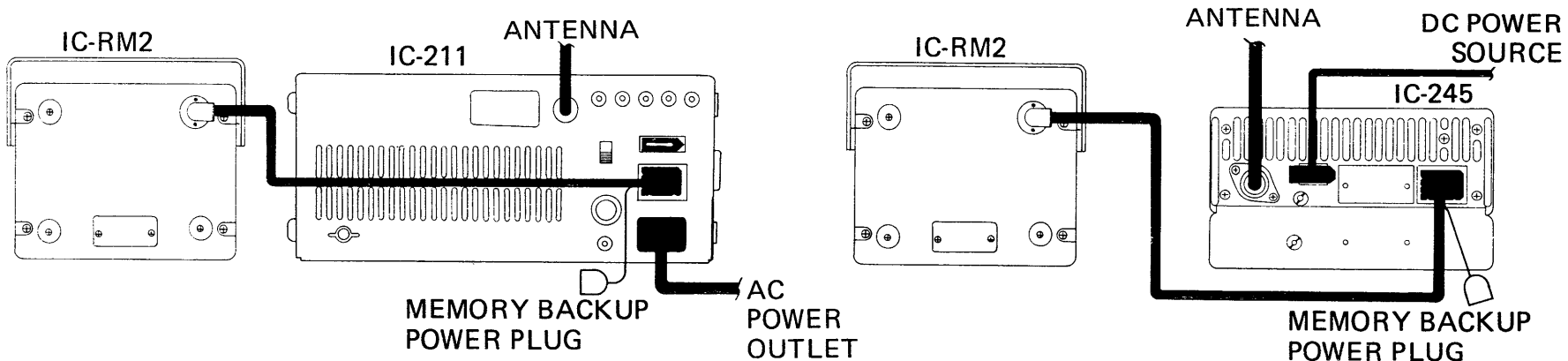

### 5 - 3 - 3 MEMORY BACKUP

Same as for the IC-701. Refer to 5 - 1 - 3 on page 10.

### 5 - 3 - 4 PRE OPERATION

Switch the Power of the IC-211/IC-245 ON.

Switch the Power of the IC-RM2 ON.

Check if "0" is displayed on the 100Hz display of the IC-RM2. If nothing is shown on the frequency display of the IC-RM2, refer to the section on TROUBLE SHOOTING and follow the instructions.

Check if the frequency display of the IC-211/IC-245 shows 144.000.0MHz.

## 5 - 4 OPERATION WITH THE IC-211/IC-245

### 5 - 4 - 1 INITIAL FREQUENCY SETTING

EXAMPLE: Set 145.2680MHz

When the last figure (the 100Hz digit) is entered by pushing the key for "0", the transceiver display shows 145.268.0 (or 5.268) with a beep sound from the IC-RM2 and the frequency setting is completed.

NOTE: Frequency setting cannot be made when in the transmit or scan mode.

KEY	Display of IC-RM2	Display of IC-211	Display of IC-245
Before	0	144.0000	4.000
M-1 1	1	144.0000	4.000
M-4 4	14	144.0000	4.000
WRITE 5	145	144.0000	4.000
*	145.	144.0000	4.000
M-2 2	145.2	144.0000	4.000
READ 6	145.26	144.0000	4.000
-DUPLEX 8	145.268	144.0000	4.000
STOP 0	145.268.0	145.268.0	5.268

The IC-RM2 beeps and the desired frequency enters into the IC-211/IC-245.

## 5 - 4 - 2 CHANGING FREQUENCIES ON THE SAME MHz BAND

When a frequency is set in the same MHz band, resetting the 100MHz, 10MHz and 1MHz digits is not necessary.

EXAMPLE: Set 145.3970MHz when the present operating frequency is 145.2680MHz.

KEY	Display of IC-RM2	Display of IC-211	Display of IC-245
Before	145.268.0	145.268.0	5.268
*	145. .	145.268.0	5.268
M-S 3	145.3 .	145.268.0	5.268
+DUPLX 9	145.39 .	145.268.0	5.268
SIMPLEX 7	145.397.	145.268.0	5.268
STOP 0	145.397.0	145.397.0	5.397

The IC-RM2 beeps immediately and the frequency of the IC-211/IC-245 changes to the desired frequency.

If you wish to change the frequency to a different MHz band, follow the same procedure as described in 5 - 4 - 1 on page 26.

### 5 - 4 - 3 IF AN INCORRECT FREQUENCY (OUT OF THE RATED RANGE) IS ENTERED

When a frequency outside the ranges below is programmed, the display shows the previously set frequency after the last digit is entered. (If the setting is the first one set after the power is turned ON, "0" is shown.)

#### OPERATIONABLE FREQUENCY RANGE

144.0000 ~ 145.9999MHz

146.0000 ~ 147.9999MHz

EXAMPLE: When 143.2680MHz is entered:

KEY	Display of IC-RM2	Display of IC-211	Display of IC-245
Before	145.397.0	145.397.0	5.397
M-1 1	1	145.397.0	5.397
M-4 4	14	145.397.0	5.397
M-3 3	143	145.397.0	5.397
.	143.	145.397.0	5.397
M-2 2	143.2	145.397.0	5.397
READ 6	143.26	145.397.0	5.397
-DUPLEX 8	143.268	145.397.0	5.397
STOP 0	145.397.0	145.397.0	5.397

The IC-211/IC-245 display does not change frequency. If no frequency was entered after the IC-RM2 was switched ON, the display of the IC-RM2 returns to  and the IC-211/IC-245 display remains  or .



### 5 - 4 - 4 ONE STEP INCREASE/DECREASE

EXAMPLE: 100Hz step increase/decrease:

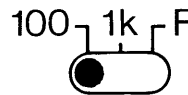

This mode does not work in the range of 146.0000 ~ 147.9999MHz.



 Set the FREQUENCY STEP switch to the "100" position.

Pushing the  key increases the frequency in 100Hz steps.

KEY	Display of IC-RM2	Display of IC-211	Display of IC-245
Before	145.397.0	145.397.0	5.397
	145.397.1	145.397.1	5.397
	145.397.2	145.397.2	5.397

Pushing the  key increases the frequency in 100Hz steps.

Before	145.397.2	145.397.2	5.397
	145.397.1	145.397.1	5.397
	145.397.0	145.397.0	5.397

Pushing the  key decreases the frequency in 100Hz steps.



NOTE: As the IC-245 has no 100Hz digit display, 100Hz steps are not registered. However, the actual

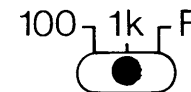

frequency of the IC-245 is changing in 100Hz steps, which can be observed by changes in the 1KHz digit display when stepping above 900Hz or below 100Hz.

EXAMPLE 2: 1KHz step increase/decrease.

This mode does not work in the range of 146.0000 ~ 147.9999MHz.

 Set the FREQUENCY STEP switch to the "1K" position.

KEY	Display of IC-RM2	Display of IC-211	Display of IC-245
Before	145.397.0	145.397.0	5.397
	145.396.0	145.396.0	5.396
	145.395.0	145.395.0	5.395



Pushing  or  increases or decreases the frequency in 1KHz steps.

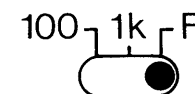



EXAMPLE 3: 15KHz step increase/decrease

 Set the FREQUENCY STEP switch to the "F" position.

The frequency increases/decreases in 15KHz steps.

### 5 - 4 - 5 CONTINUOUS SCANNING

Depress the  key or  key for more than 0.4 seconds and the frequency is now in the scan mode and continuously shifts upward or downward. When the operating frequency reaches the highest or lowest edge of the operating frequency ranges (144.0000 ~ 145.9999MHz and 146.0000 ~ 147.9999MHz are different ranges, shown on page 28), it jumps to the opposite edge of the range and keeps scanning in the same direction.

Stop the scan by pushing the  key. While scanning, none of the keys function except the  key. When the  key is pushed twice, the display frequency is changed to "0". However, the actual operating frequency is not changed and can be reset on the display by keying .

Set the FREQUENCY STEP switch to the desired step position.

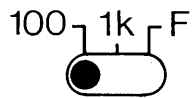

100Hz step scanning

This mode does not work in the range of 146.0000 ~ 147.9999MHz.

The display of IC-245 does not change by changing of 100Hz digits, but the actual frequency changes in 100Hz steps.

(See 5 - 4 - 4)

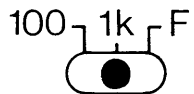

1KHz step scanning

This mode does not work in the range of 146.0000 ~ 147.9999MHz.

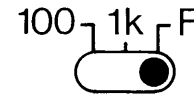

15KHz step scanning



EXAMPLE: 100Hz step scanning upward.

KEY	Display of IC-RM2	Display of IC-211	Display of IC-245
Before	145.395.0	145.395.0	5.395
	145.395.1	145.395.1	5.395
Hold for more than 0.4 seconds	145.395.2	145.395.2	5.395
	145.395.3	145.395.3	5.395
	145.395.4	145.395.4	5.395

The frequency will continuously scan in 100Hz steps until you push the  key.

	145.450.0	145.450.0	5.450
---	-----------	-----------	-------

When the  key is pushed twice by mistake.

	0	145.450.0	5.450
	145.450.0	145.450.0	5.450

## 5 - 4 - 6 WRITING FREQUENCIES INTO THE MEMORY CHANNELS.



Set a desired frequency on the display by keying, scanning, etc.

If the desired frequency is 144.650.0MHz: See Example 1.

If the desired frequency is 145.725.0MHz: See Example 2.



Program two more frequencies you need in Memory Channels 3 and 4 in the same manner (any frequencies within the operation ranges).

### EXAMPLE 1: MEMORY WRITING into M-1

KEY	Display of IC-RM2	Display of IC-211	Display of IC-245
Before	144.650.0	144.650.0	4.650
	144.650.0	144.650.0	4.650
	144.650.0	144.650.0	4.650
	144.650.0	144.650.0	4.650

The frequency 144.6500MHz is written into M-1.

### EXAMPLE 2: MEMORY WRITING into M-2

KEY	Display of IC-RM2	Display of IC-211	Display of IC-245
Before	145.725.0	145.725.0	5.725
	145.725.0	145.725.0	5.725
	145.725.0	145.725.0	5.725
	145.725.0	145.725.0	5.725

The frequency 145.7250MHz is written into M-2.

You can write any frequency into M-1 - M-4 using the same procedure.

## 5 - 4 - 7 READING THE PROGRAMMED MEMORY CHANNELS

Follow the key operations below to recall the frequency programmed into Memory Channel 1.

The programmed frequency in Memory Channel 1, 144.650.0MHz is displayed, the IC-211/IC-245 display shows 144.650.0MHz and a beep will be heard from the IC-RM2.

The same procedure recalls the programmed frequencies in the other Memory Channels.

**EXAMPLE:** When programmed frequencies in the Memory Channels are as follows:

M-1	
M-2	
M-3	

### 1: Reading M-1

KEY	Display of IC-RM2	Display of IC-211	Display of IC-245
Before			

The IC-RM2 beeps and M-1's frequency enters to the IC-211/IC-245.

### 2: Reading M-2

### 3: Reading M-3

## 5 - 4 - 8 MEMORY SCANNING

One-Step Scan of the programmed frequencies can be accomplished by pushing the  <sup>PS/MS</sup> key. But the scan can be made only among the Memory Channels in which the programmed frequencies are in the same band set when the  <sup>PS/MS</sup> key is pushed.

The scanning order of the recalled channels is from Memory Channel 1 to 4. However, the channels without programmed frequencies and channels with programmed frequencies in other operating frequency ranges are skipped when the  <sup>PS/MS</sup> key is pushed.

Continuous scan among the Memory Channels can be accomplished by depressing  <sup>PS/MS</sup> for more than 0.4 seconds. This scan is made only among the Memory Channels with the frequencies in the same band as the set frequency at the time the  <sup>PS/MS</sup> key is pushed. To stop the scan, push the  <sup>STOP</sup> key. (144.0000~145.9999MHz and 146.0000~147.9999 MHz are different band, see page 28.)

EXAMPLE 1: When programmed frequencies in memories are as follows:

M-1	<input type="text" value="144.650.0"/>
M-2	<input type="text" value="145.725.0"/>
M-3	<input type="text" value="145.972.3"/>
M-4	<input type="text" value="144.123.4"/>

KEY	Display of IC-RM2	Display of IC-211	Display of IC-245
Before	<input type="text" value="145.100.0"/>	<input type="text" value="145.100.0"/>	<input type="text" value="5.100"/>
<input type="checkbox"/> <sup>PS/MS</sup>	<input type="text" value="144.650.0"/>	<input type="text" value="144.650.0"/>	<input type="text" value="4.650"/>
<input type="checkbox"/> <sup>PS/MS</sup>	<input type="text" value="145.725.0"/>	<input type="text" value="145.725.0"/>	<input type="text" value="5.725"/>
<input type="checkbox"/> <sup>PS/MS</sup>	<input type="text" value="145.972.3"/>	<input type="text" value="145.972.3"/>	<input type="text" value="5.972"/>
<input type="checkbox"/> <sup>PS/MS</sup>	<input type="text" value="144.123.4"/>	<input type="text" value="144.123.4"/>	<input type="text" value="4.123"/>
<input type="checkbox"/> <sup>PS/MS</sup>	<input type="text" value="144.650.0"/>	<input type="text" value="144.650.0"/>	<input type="text" value="4.650"/>

EXAMPLE 2: When programmed frequencies in memories are as follows:

M-1	<input type="text" value="145.725.0"/>
M-2	<input type="text" value="146.340.0"/>
M-3	NO PROGRAM
M-4	<input type="text" value="144.650.0"/>

Before	<input type="text" value="145.100.0"/>	<input type="text" value="145.100.0"/>	<input type="text" value="5.100"/>
<input type="checkbox"/> <sup>PS/MS</sup>	<input type="text" value="145.725.0"/>	<input type="text" value="145.725.0"/>	<input type="text" value="5.725"/>
<input type="checkbox"/> <sup>PS/MS</sup>	<input type="text" value="144.650.0"/>	<input type="text" value="144.650.0"/>	<input type="text" value="4.650"/>
<input type="checkbox"/> <sup>PS/MS</sup>	<input type="text" value="145.725.0"/>	<input type="text" value="145.725.0"/>	<input type="text" value="5.725"/>

### 5 - 4 - 9 SPECIFIED RANGE SCANNING



The IC-RM2 can be programmed using M-4 as a reference point, to scan from the entered frequency up or down to memory M-4 and back to the entered frequency.

This allows you to scan a set portion of the band without having to scan the entire band.



**NOTE:** You can not scan across different bands.  
(144.0000 ~ 145.9999MHz and 146.0000 ~ 147.9999MHz.)







**EXAMPLE:** Scanning between 144.9500MHz and 145.2680MHz.

1. Enter the lower edge or higher edge frequency into M-4 memory.

KEY	Display of IC-RM2	Display of IC-211	Display of IC-245
Before	144.950.0	144.950.0	4.950
	144.950.0	144.950.0	4.950
 5	144.950.0	144.950.0	4.950
 4	144.950.0	144.950.0	4.950



2. Enter another edge frequency on the display.

 1	1	144.950.0	4.950
 4	14	144.950.0	4.950

KEY	Display of IC-RM2	Display of IC-211	Display of IC-245
 5	145	144.950.0	4.950
	145. .	144.950.0	4.950
 2	145.2 .	144.950.0	4.950
 6	145.26 .	144.950.0	4.950
 8	145.268.	144.950.0	4.950
 0	145.268.0	145.268.0	5.268

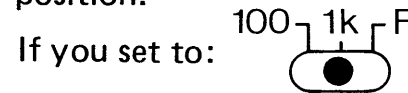
3. Set the FREQUENCY STEP switch to the desired step position.



	145.268.0	145.268.0	5.268
	145.267.0	145.267.0	5.267
Hold more than 0.4 seconds	145.266.0	145.266.0	5.266
↓	144.951.0	144.951.0	4.951
	144.950.0	144.950.0	4.950
	144.951.0	144.951.0	4.951



The frequency scans to the lower edge and returns to the higher edge in the desired steps until you push the  key.

## 5 - 4 - 10 DUPLEX OPERATION



1. Set the DUPLEX SPLIT SELECT switch at the desired split position (600K or 1M).



2. Enter desired receiving frequency on the display by keying, scanning, etc.

3. Push the  key and then the  key, if the desired transmitting frequency is below the receiving frequency, or the  key, if the desired transmitting frequency is above the receiving frequency.

This completes the DUPLEX operation setting for 600KHz or 1MHz separation. For separations other than these two, refer to section 5 - 4 - 11 on page 36.

- \* To cancel this function, push  and then .

**NOTE:** Once a duplex mode is selected with the IC-RM2, it will memorize the duplex split selected, either 600K, 1M or M-4, and retain that split even if the DUPLEX SPLIT SELECT switch is moved. To select another duplex split it is necessary to return to the SIMPLEX mode, move the DUPLEX SPLIT SELECT switch to the desired split then go back to duplex.

**EXAMPLE:** Receiving frequency is 145.7250MHz and transmitting frequency is 600KHz below the receiving frequency.

1. Set the DUPLEX SPLIT SELECT switch to the "600K" position.

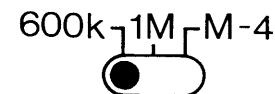



2. Enter the receiving frequency (145.7250MHz) on the display.

KEY	Display of IC-RM2	Display of IC-211	Display of IC-245
-----	-------------------	-------------------	-------------------

	145.725.0	145.725.0	5.725
--	-----------	-----------	-------

Then

	145.725.0	145.725.0	5.725
---	-----------	-----------	-------

	145.725.0	145.725.0	5.725
--	-----------	-----------	-------

**DUPLEX**  The DUPLEX INDICATOR is lit and shows that you are ready for split frequency operation.

T/R switch or PTT switch changes to TRANSMIT.

	145.125.0	145.125.0	5.125
--	-----------	-----------	-------

## 5 - 4 - 11 SPLIT FREQUENCY OPERATION



This function allows you to set any split frequency within the operationable frequency range.

(Use of the IC-RM2 allows operation on "5KHz" splits not normally obtainable with the IC-211/IC-245 alone, 146.435MHz transmit and 147.000MHz receive.)

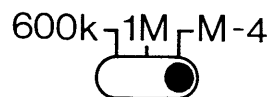

1. Set the DUPLEX SPLIT SELECT switch to the M-4 position.



2. Enter desired transmitting frequency into M-4 memory.
3. Enter desired receiving frequency on the display by keying, scanning, etc.



4. Push  key and then either  or .

This completes the setting, and the M-4 frequency appears during transmit, and the other frequency previously set is displayed during receive.

- \* To cancel this function, push  and then .



**NOTE:** If the setting is cancelled after setting for Split frequency operation without putting the IC-211/IC-245 at least once in the transmit mode, the display frequency may be changed. To avoid this problem, make sure to set the IC-211/IC-245 in the transmit mode even once before cancelling the split frequency set.

**EXAMPLE:** Enter desired transmitting frequency on the display.

KEY	Display of IC-RM2	Display of IC-211	Display of IC-245
Before	144.435.5	144.435.5	4.435
	144.435.5	144.435.5	4.435
 5	144.435.5	144.435.5	4.435
 4	144.435.5	144.435.5	4.435

The frequency 144.4355MHz is written into M-4.

Enter desired receiving frequency on the display.

	145.731.0	145.731.0	5.731
	145.731.0	145.731.0	5.731
 8	145.731.0	145.731.0	5.731

 **DUPLEX** The DUPLEX INDICATOR is lit and shows that you are ready for split frequency operation.

T/R switch or PTT switch changes to TRANSMIT.

144.435.5	144.435.5	4.435
-----------	-----------	-------

T/R switch or PTT switch returned to RECEIVE.

145.731.0	145.731.0	5.731
-----------	-----------	-------

## 5 - 4 - 12 WHEN THE IC-RM2 IS TURNED OFF THEN ON AGAIN

While the IC-RM2 is in operation, the Tuning Control of the IC-211/IC-245 is locked and the operating frequency is not controlled by rotating the Tuning Control. To tune with the Tuning Control, the IC-RM2 must be turned OFF.

When the IC-RM2 is turned ON again, only the display for the MHz band is shown on the IC-RM2. The frequency setting for a frequency on the same MHz band can be made only by setting figures for 100KHz and below. Pushing "RESET" shows the previously set frequency on the IC-RM2. However, the frequency of the IC-211/IC-245 is not set at this frequency, which is different from the IC-RM2 frequency. Therefore, the frequency which appears on the IC-RM2 display by pushing "RESET" is for checking at which frequency the IC-RM2 was previously set.

### EXAMPLE:

KEY	Display of IC-RM2	Display of IC-211	Display of IC-245
Using IC-RM2	145.73 1.0	145.73 1.0	5.73 1
Power switch set to OFF		145.73 1.0	5.73 1

After rotating the tuning control knob of the IC-211/IC-245 to tune around the frequency.

		145.825.0	5.825
Power switch is turned ON again	145. .	145.825.0	5.825
RESET	145.73 1.0	145.825.0	5.825
UP	145.732.0	145.732.0	5.732
DOWN #	145.73 1.0	145.73 1.0	5.73 1

You can return to the previous frequency.

## 5 - 4 - 13 TOUCH TONE OPERATION

Some repeater groups have provided an interconnection to the public telephone network through an autopatch device.

Such interconnection has led to the widespread use of the telephone company's Touch-Tone system of tone signaling for repeater control functions, as well as telephone dialing.

The IC-RM2 has a Touch-Tone system for these functions.

The Touch-Tone control system consists of pairs of tones (see the chart below) for each of 10 numbers and the two special functions. One tone from the high-frequency group is generated simultaneously with one tone from the low-frequency group to represent each number or function.

Low Tone	High Tone		
	1209Hz	1336Hz	1477Hz
697Hz	1	2	3
770Hz	4	5	6
852Hz	7	8	9
941Hz	*	0	#

1. Set the IC-211/IC-245 in the TRANSMIT mode with the T/R switch or PTT switch.

2. Push the  key.

 The TONE, INDICATOR is lit and shows that you are ready for the TOUCH TONE operation.

3. Push desired number keys  through  or function keys  and , for repeater control or telephone dialing.

4. To cancel the TOUCH-TONE operation, push the  key again or set the IC-211/IC-245 in the RECEIVE mode.

5. Adjustment of the level of the tones for TOUCH-TONE is accomplished by removing the back of the IC-RM2 and adjusting R57.

## SECTION 6 OPTIONAL MODIFICATIONS

### 6-1 WHEN THE BEEP TONE IS NOT DESIRED

When the beep tone for the frequency set indication is not desired, change the pin connected to J3 and reconnect it to J4 on the IC-RM2 printed circuit board.

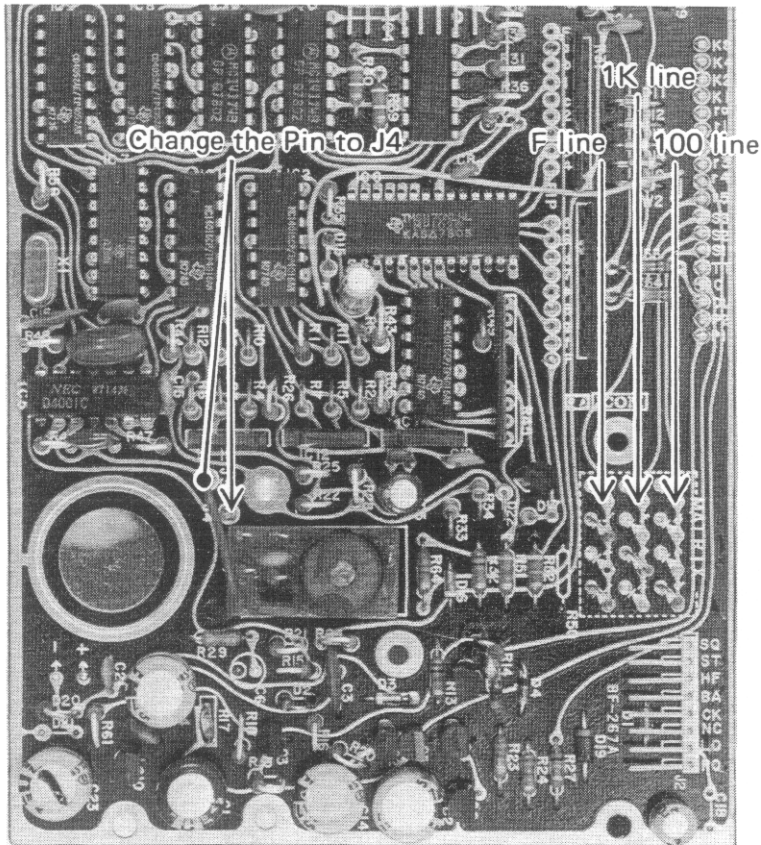

### 6-2 WHEN YOU DESIRE TO CHANGE FREQUENCY STEPS

The F position on the Frequency Steps Select switch is an internally programmed position that is factory set at 15KHz.

Other steps are also available by changing diode positions on an internal matrix inside of the IC-RM2 as follow.

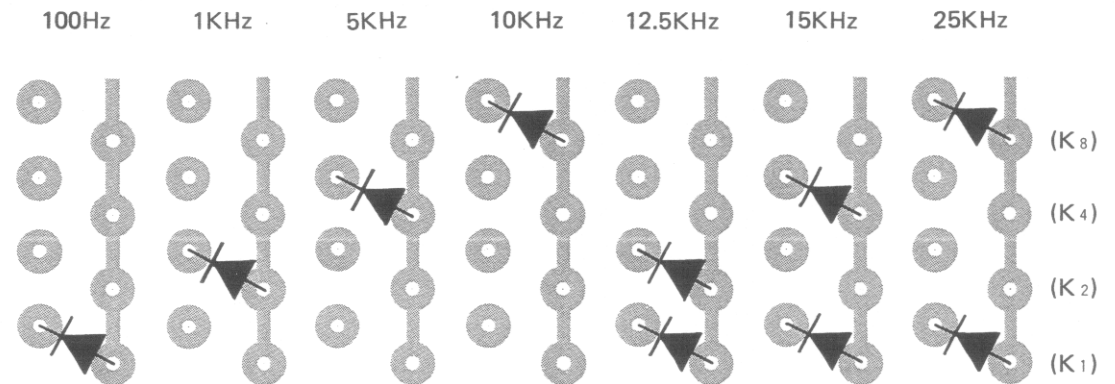

# SECTION 7 INSIDE VIEW

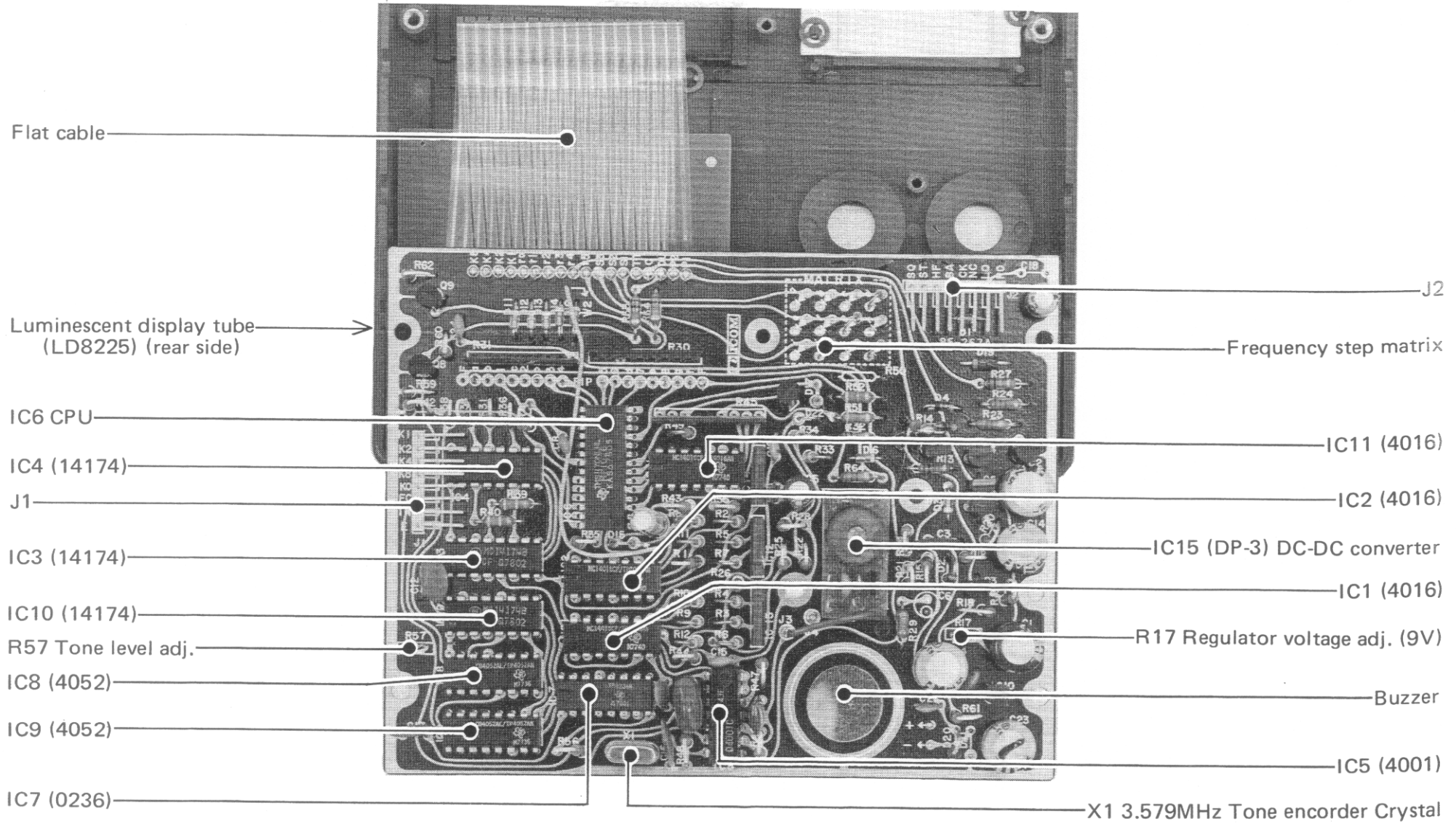

## SECTION 8 TROUBLE SHOOTING

Your IC-RM2 has been tested very carefully at the factory before shipping. The chart below has been designed to help you correct any problems which are not equipment malfunctions. If you are not able to locate the problem and/or solve it through use of this chart, please contact your dealer or ICOM distributor for assistance.

Problem	Possible Cause	Solution
1. Nothing displayed on the display.	<p>The power is not turned ON.</p> <p>The connection of the cable is not made.</p>	<p>Turn OFF both the power switches of the transceiver and IC-RM2 and turn them ON again.</p> <p>Turn the Power switch ON.</p> <p>Make the proper connection of the cable.</p>
2. Frequency set cannot be made by keying the board.	<p>Another operation is being performed.</p> <p>The transceiver is in the transmit mode.</p> <p>The frequency entered is outside the operationable frequency ranges.</p>	<p>Push the "RESET" key.</p> <p>Set the transceiver in the receive mode.</p> <p>Set the frequency within the operationable ranges.</p>
3. The displayed frequency on the transceiver is different from the frequency on the IC-RM2 display.	<p>The Fast Tuning switch of the transceiver is engaged.</p> <p>The connection of the cable is not proper.</p> <p>The Band switch is not in the EXT position (IC-701 only).</p>	<p>Try to enter the frequency again.</p> <p>Set the Fast Tuning switch OFF.</p> <p>Connect the cable properly to the ACC socket of the transceiver.</p> <p>Set the Band Switch in the EXT position. (IC-701 only)</p>

Problem	Possible Cause	Solution
4. An abnormal figure is shown on the display.	The supplied power voltage is not proper.	Adjust the supplied power voltage for proper value.  Turn all the power switches OFF, and 2 or 3 seconds after, turn them ON again.
5. SCAN does not function.	The transceiver is in the transmit mode. Another operation is being performed.	Set the transceiver in the receive mode. Push the "RESET" key.
6. Memory scan or program scan does not function.	No frequency is programmed in the memory channels.  The programmed frequencies are for bands other than the band currently set.	Program frequencies in the memory channels.  Program frequencies in the same band, or change the band set.



# SECTION 10 P.C. BOARD LAYOUT

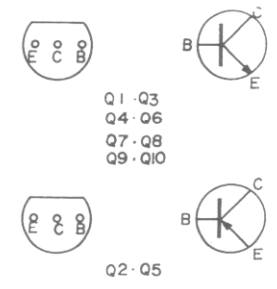
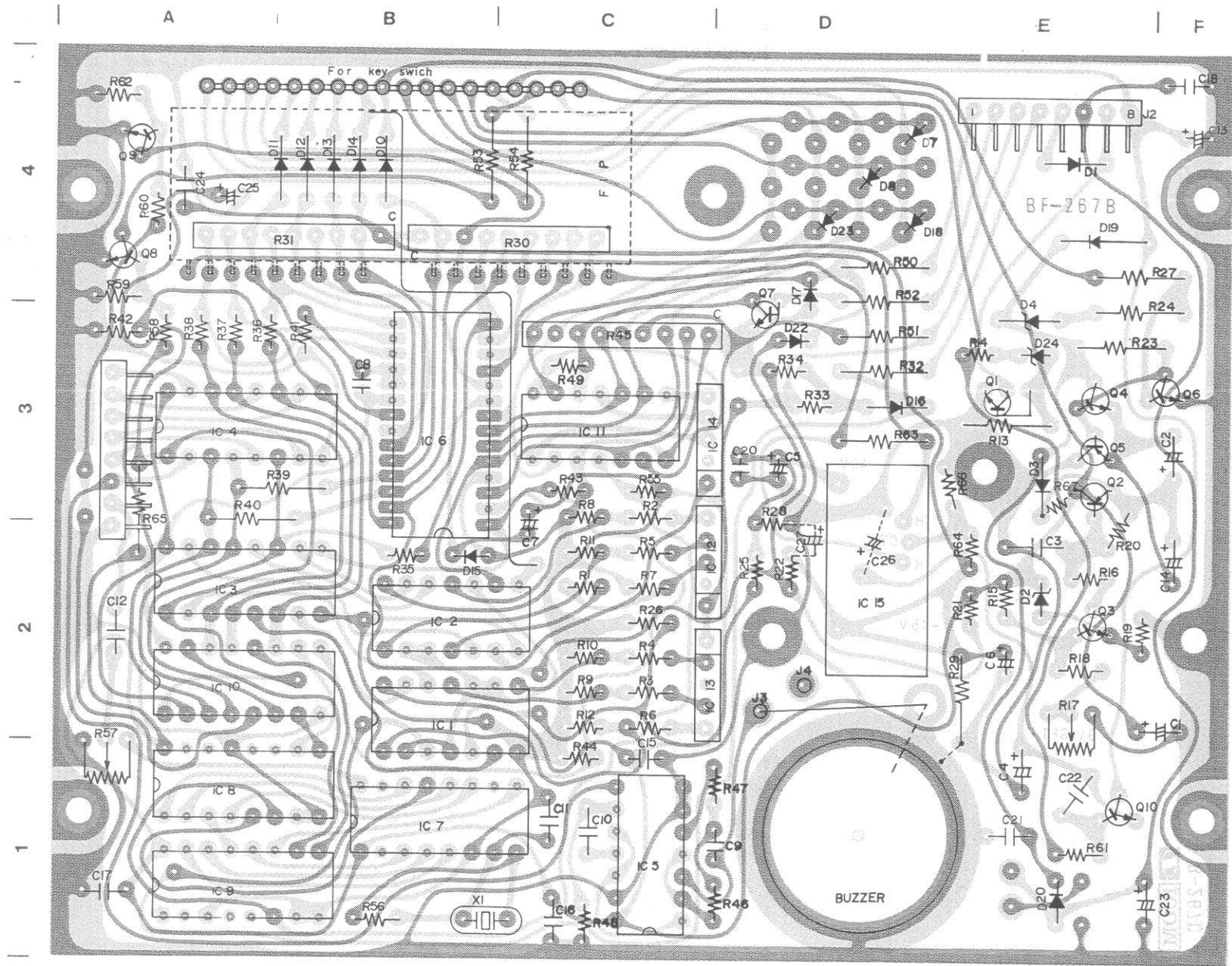

# IC-RM2 SCHEMATIC DIAGRAM

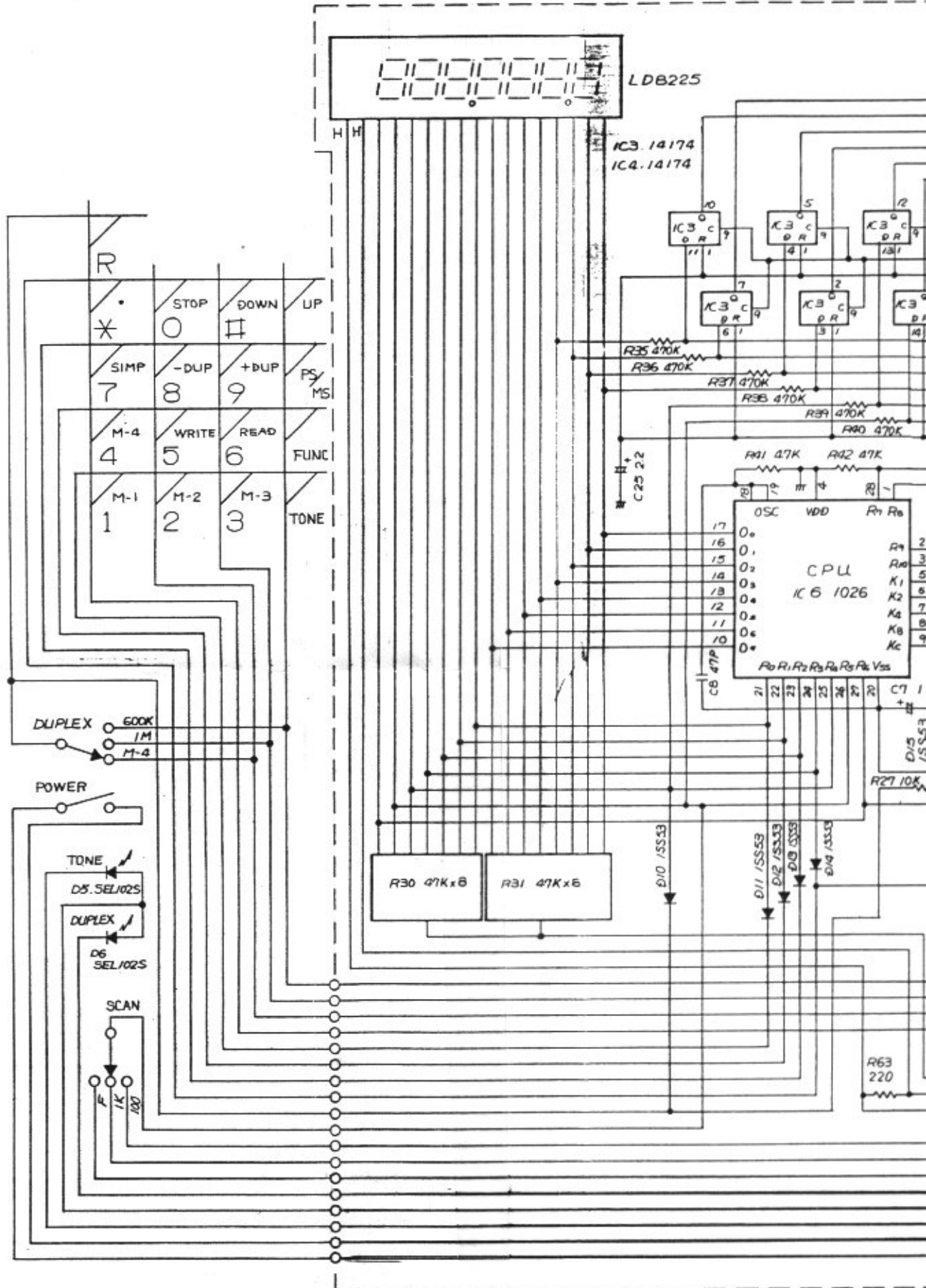

# DIAGRAM

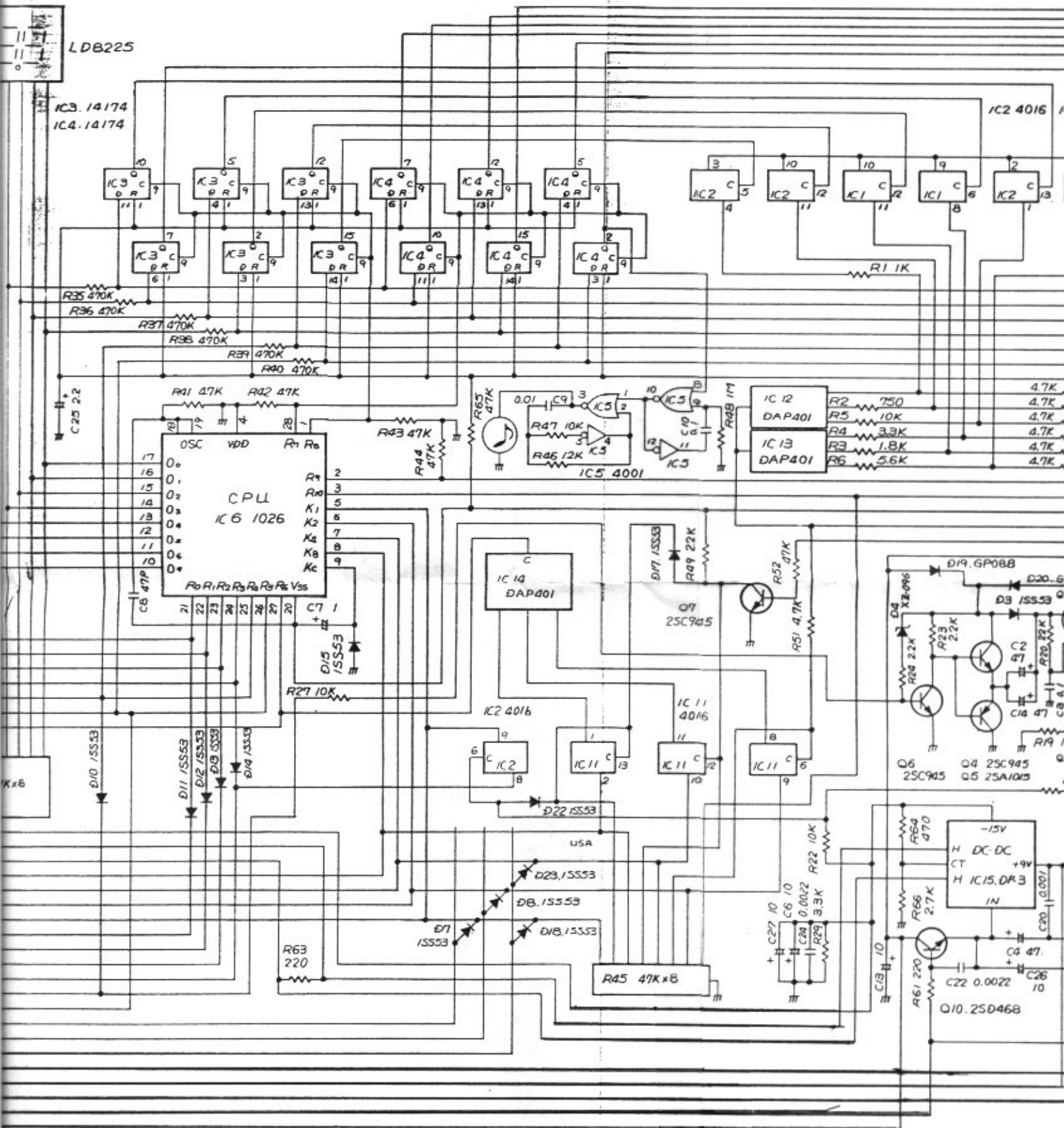

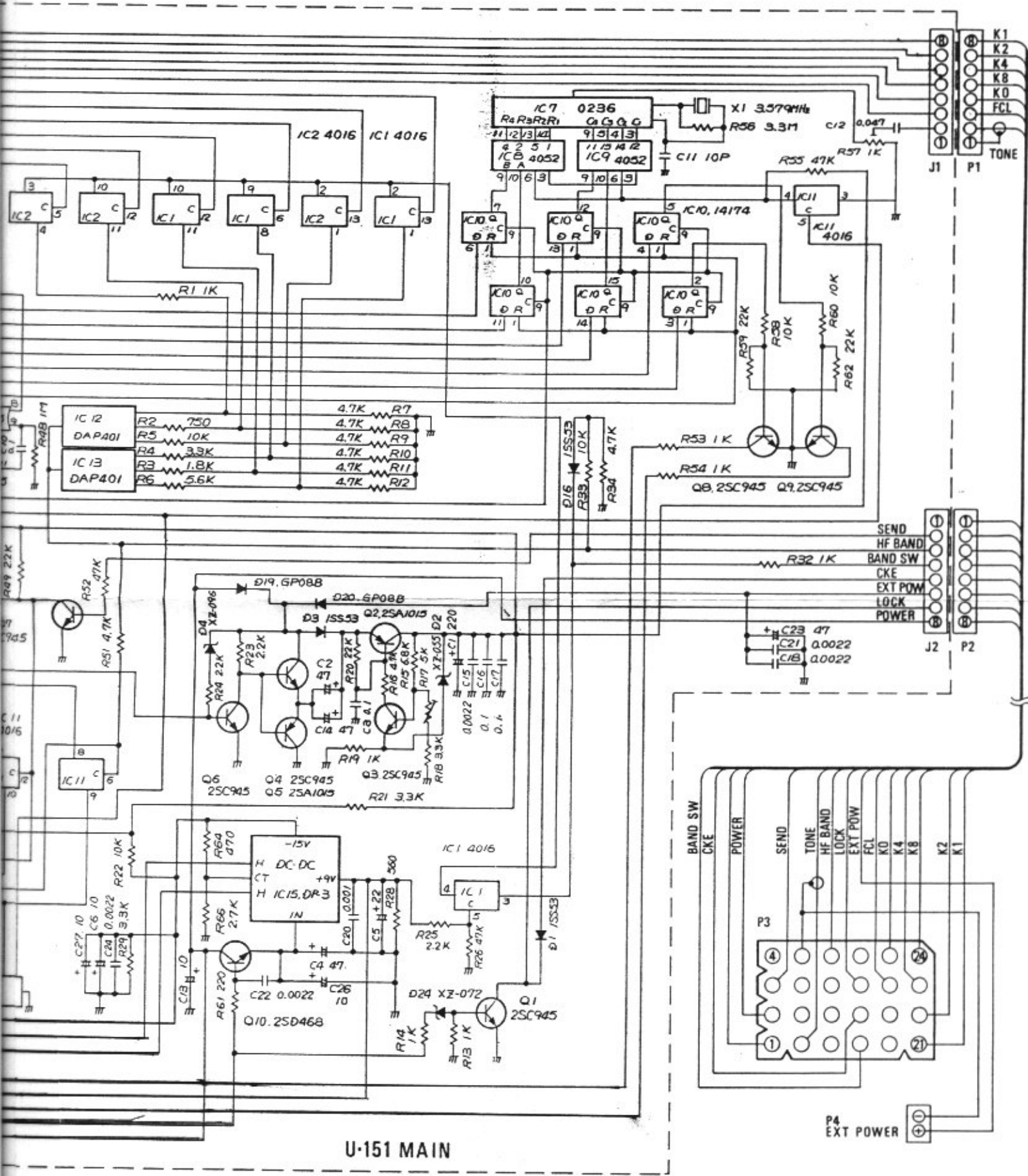

U-151 MAIN

OM INCORPORATED

Some components subject to change for an improvement without notice.

A-0094

# RM2 SCHEMATIC DIAGRAM

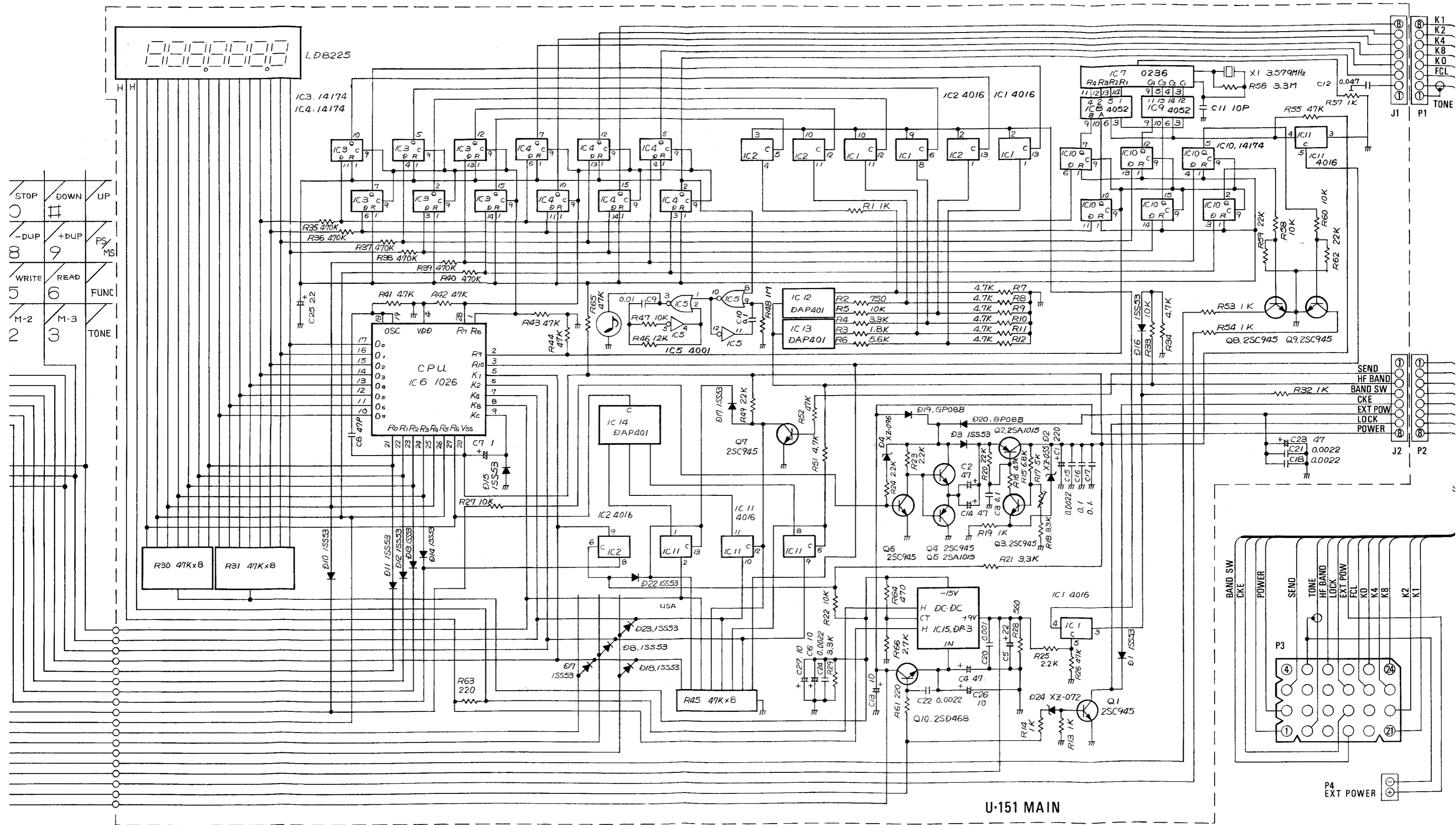

U-151 MAIN

**ICOM**



**ICOM INCORPORATED**

1-6-19, KAMI KURATSUKURI, HIRANO-KU,  
OSAKA JAPAN

Printed in Japan