



INSTRUCTION MANUAL

HF ALL BAND TRANSCEIVER
IC-718



IMPORTANT

READ ALL INSTRUCTIONS carefully and completely before using the transceiver.

SAVE THIS INSTRUCTION MANUAL— This instruction manual contains basic operating instructions for the IC-718.

EXPLICIT DEFINITIONS

WORD	DEFINITION
⚠ DANGER!	Personal death, serious injury or an explosion may occur.
⚠ WARNING!	Personal injury, fire hazard or electric shock may occur.
CAUTION	Equipment damage may occur.
NOTE	Recommended for optimum use. No risk of personal injury, fire or electric shock.

PRECAUTIONS

⚠ **DANGER HIGH VOLTAGE! NEVER** touch an antenna connector during transmission. This may result in an electrical shock or burn.

⚠ **WARNING RF EXPOSURE!** This radio emits Radio Frequency (RF) energy. Extreme caution should be observed when operating this radio. If you have any questions regarding RF exposure and safety standards please refer to the Federal Communications Commission Office of Engineering and Technology's report on Evaluating Compliance with FCC Guidelines for Human Radio Frequency Electromagnetic Fields (OET Bulletin 65).

⚠ **WARNING! NEVER** operate the radio while driving a vehicle. Safe driving requires your full attention—anything less may result in an accident.

⚠ **WARNING! NEVER** operate the radio with an earphone or other audio accessories at high volume levels. Continuous high volume operation may cause a ringing in your ears. If you experience ringing, reduce the volume level or discontinue use.

⚠ **WARNING! NEVER** connect the radio to an AC outlet. This may pose a fire hazard or result in an electric shock.

⚠ **WARNING! NEVER** connect the radio to a power source of more than 16 V DC such as a 24 V DC. This could cause a fire or damage the radio.

⚠ **WARNING! NEVER** reverse the DC power cable polarity when connecting to a power source. This could damage the radio.

⚠ **WARNING! NEVER** cut the DC power cable between the DC plug and fuse holder. If an incorrect connection is made after cutting, the radio may be damaged.

⚠ **WARNING! NEVER** let metal, wire or other objects touch any internal part or connectors on the rear panel of the radio. This may result in an electric shock or this could cause a fire or damage the radio.

⚠ **WARNING! NEVER** operate or touch the radio with wet hands. This may result in an electric shock or may damage the radio.

⚠ **WARNING!** Immediately turn the radio power OFF and remove the power cable if it emits an abnormal odor, sound or smoke. Contact your Icom dealer or distributor for advice.

CAUTION: NEVER expose the radio to rain, snow or any liquids.

CAUTION: NEVER change the internal settings of the radio. This may reduce radio performance and/or damage to the radio.

CAUTION: NEVER place the radio where normal operation of the vehicle may be hindered or where it could cause bodily injury.

DO NOT operate the radio near unshielded electrical blasting caps or in an explosive atmosphere.

DO NOT push the PTT when not actually desiring to transmit.

DO NOT use harsh solvents such as benzine or alcohol to clean the radio, as they will damage the radio's surfaces. If the radio becomes dusty or dirty, wipe it clean with a soft, dry cloth.

DO NOT operate or place the radio in areas with temperatures below -10°C ($+14^{\circ}\text{F}$) or above $+60^{\circ}\text{C}$ ($+140^{\circ}\text{F}$).

Be aware that temperatures on a vehicle's dashboard can exceed $+80^{\circ}\text{C}$ ($+176^{\circ}\text{F}$) in direct sunlight, resulting in permanent damage to the radio if left there for extended periods.

PRECAUTIONS (Continued)

DO NOT place the radio in excessively dusty environments or in direct sunlight.

DO NOT place the radio against walls or put anything on top of the radio. This will obstruct heat dissipation.

Place the radio in a secure place to avoid inadvertent use by children.

During mobile operation, **NEVER** place the radio where air bag deployment may be obstructed.

During mobile operation, **DO NOT** place the radio where hot or cold air blows directly onto it.

During mobile operation, **DO NOT** operate the radio without running the vehicle's engine. When radio power is ON and your vehicle's engine is OFF, the vehicle's battery will soon become exhausted.

Make sure the radio power is OFF before starting the vehicle engine. This will avoid possible damage to the radio by ignition voltage spikes.

During maritime mobile operation, keep the radio and microphone as far away as possible from the magnetic navigation compass to prevent erroneous indications.

BE CAREFUL! The heatsink will become hot when operating the radio continuously for long periods of time.

BE CAREFUL! If a linear amplifier is connected, set the radio's RF output power to less than the linear amplifier's maximum input level, otherwise, the linear amplifier will be damaged.

Use only supplied or optional Icom microphones. Other manufacturer's microphones have different pin assignments, and connecting to the IC-718 may damage the radio.

ABOUT CE AND DOC



Hereby, Icom Inc. declares that the versions of IC-718 which have the "CE" symbol on the product, comply with the essential requirements of the Radio Equipment Directive, 2014/53/EU, and the restriction of the use of certain hazardous substances in electrical and electronic equipment Directive, 2011/65/EU. The full text of the EU declaration of conformity is available at the following internet address:
<http://www.icom.co.jp/world/support>

FCC INFORMATION

• FOR CLASS B UNINTENTIONAL RADIATORS

This equipment has been tested and found to comply with the limits for a Class B digital device, pursuant to part 15 of the FCC Rules. These limits are designed to provide reasonable protection against harmful interference in a residential installation. This equipment generates, uses and can radiate radio frequency energy and, if not installed and used in accordance with the instructions, may cause harmful interference to radio communications. However, there is no guarantee that interference will not occur in a particular installation. If this equipment does cause harmful interference to radio or television reception, which can be determined by turning the equipment off and on, the user is encouraged to try to correct the interference by one or more of the following measures:

- Reorient or relocate the receiving antenna.
- Increase the separation between the equipment and receiver.
- Connect the equipment into an outlet on a circuit different from that to which the receiver is connected.
- Consult the dealer or an experienced radio/TV technician for help.

This device complies with Part 15 of the FCC Rules. Operation is subject to the following two conditions: (1) this device may not cause harmful interference, and (2) this device must accept any interference received, including interference that may cause undesired operation.

WARNING: MODIFICATION OF THIS DEVICE TO RECEIVE CELLULAR RADIOTELEPHONE SERVICE SIGNALS IS PROHIBITED UNDER FCC RULES AND FEDERAL LAW.

CAUTION: Changes or modifications to this device, not expressly approved by Icom Inc., could void your authority to operate this device under FCC regulations.



DISPOSAL

The crossed-out wheeled-bin symbol on your product, literature, or packaging reminds you that in the European Union, all electrical and electronic products, batteries, and accumulators (rechargeable batteries) must be taken to designated collection locations at the end of their working life. Do not dispose of these products as unsorted municipal waste. Dispose of them according to the laws in your area.

SUPPLIED ACCESSORIES

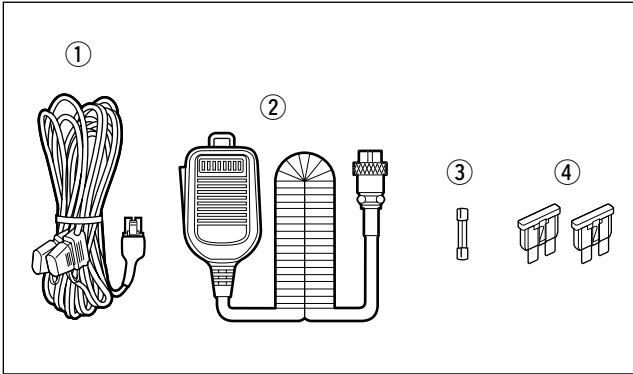

The transceiver comes with the following accessories.

	Qty.
① DC power cable	1
② Hand microphone (HM-36)	1
③ Fuse (FGB 4 A; internal fuse)	1
④ Fuse (ATQ 25 A; for DC cable)	2

IMPORTANT	i	8 SET MODE	41-47
EXPLICIT DEFINITIONS	i	■ General	41
PRECAUTIONS	i-ii	■ Quick Set mode items	42-43
FCC INFORMATION	ii	■ Initial Set mode items	44-47
SUPPLIED ACCESSORIES	iii	9 INSTALLATION AND CONNECTIONS	48-51
1 TABLE OF CONTENTS	1	■ Opening the transceiver's case	48
2 PANEL DESCRIPTION	2-8	■ Installing the MB-118	
■ Front panel	2	MOBILE MOUNTING BRACKET	48
■ Function display	5	■ CR-338 HIGH STABILITY CRYSTAL UNIT	49
■ Rear panel	6	■ UT-106 DSP RECEIVE UNIT	50
■ Microphone (HM-36)	8	■ Optional IF filters	50
3 INSTALLATION AND CONNECTIONS	9-14	■ AT-180 internal switch	51
■ Unpacking	9	10 MAINTENANCE	52-53
■ Selecting a location	9	■ Troubleshooting	52
■ Grounding	9	■ Fuse replacement	53
■ Connecting an antenna	9	■ Resetting the CPU	53
■ Required connections	10	11 SPECIFICATIONS	54
■ Advanced connections	11	12 OPTIONS	55-56
■ Connecting the Power supply	12	13 CONTROL COMMAND	57-58
■ Connecting a liner amplifier	13	■ Remote jack (CI-V) information	57
■ External antenna tuners	14	14 INSTALLATION NOTES	59
4 FREQUENCY SETTINGS	15-19	INDEX	60-62
■ Resetting the CPU	15		
■ Initial settings	15		
■ VFO description	16		
■ Frequency setting	17		
■ Dial lock function	19		
5 RECEIVE AND TRANSMIT	20-34		
■ Mode selection	20		
■ RF gain and Squelch	20		
■ Function for receive	21		
■ DSP function			
(Requires an optional UT-106 DSP UNIT)	23		
■ Filter selection	24		
■ Filter setting	25		
■ Split frequency operation	26		
■ SWR	26		
■ Function for transmit	27		
■ Function for CW	31		
■ Function for RTTY	33		
6 MEMORY OPERATION	35-38		
■ Memory channels	35		
■ Memory channel selection	35		
■ Memory channel entry	36		
■ Transferring data to the VFO	37		
■ Memory clearing	38		
7 SCANS	39-40		
■ Scan types	39		
■ Preparation	39		
■ Programmed scan operation	40		
■ Memory scan operation	40		

■ Front panel

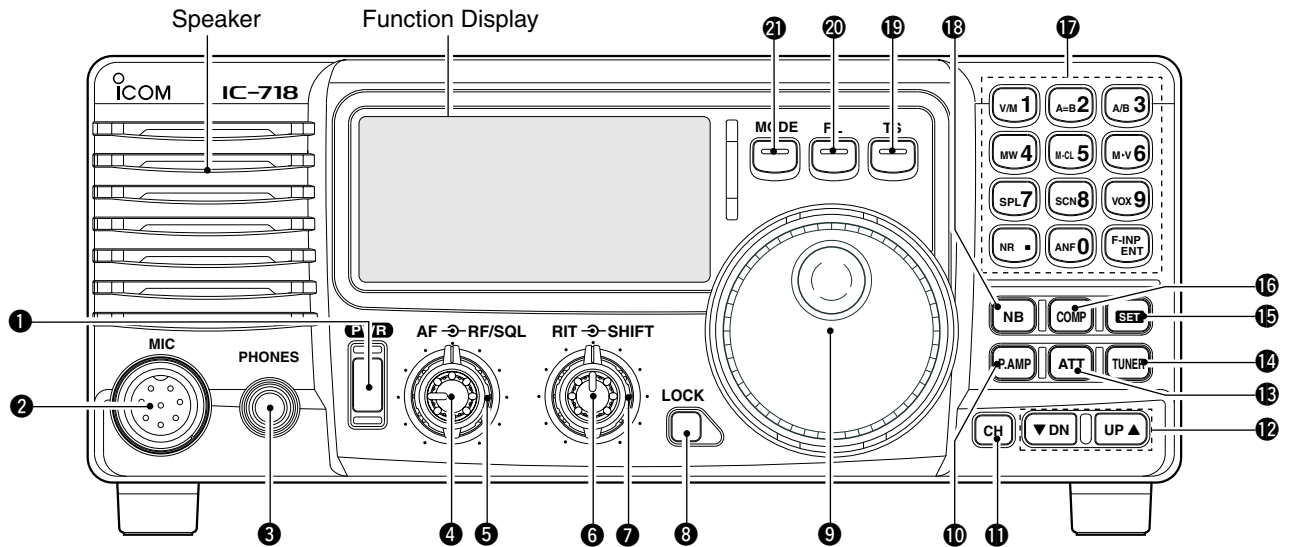

1 POWER SWITCH [PWR]

- ➔ Push momentarily to turn ON the power.
 - First, confirm the optional DC power supply is ON.
- ➔ Hold down for 1 second to turn OFF the power.
- ➔ While holding down [SET], push [PWR] to enter the Initial Set mode. (p. 41)

2 MICROPHONE CONNECTOR [MIC]

- Connect supplied or optional microphone.
- See p. 55 for appropriate microphones.
- See p. 8 for microphone connector information.

3 HEADPHONE JACK [PHONES] (p. 11)

- Connect headphones (8 Ω).
- When headphones are connected, the internal speaker or external speaker does not function.

4 AF CONTROL [AF] (inner control)

- Rotate to adjust the audio output level.

5 RF GAIN/SQUELCH CONTROL [RF/SQL]

- (outer control: pp. 20, 44)
- Rotate to adjust the squelch threshold level. The squelch removes noise output from the speaker (closed condition) when no signal is received.
- The squelch is usable for all modes.
- The control can be set as the squelch plus RF gain controls or squelch control only (RF gain is fixed at maximum) in initial set mode.

6 RIT CONTROLS [RIT] (Inner control: p. 21)

- ➔ Rotate to shift the receive frequency without changing the transmit frequency.
 - Rotate clockwise to increase the frequency, or rotate counterclockwise to decrease the frequency. “**RIT**” appears on the display.
 - The shift frequency range is ± 1.2 kHz.

7 IF SHIFT CONTROLS [SHIFT]

- (Outer control: p. 21)
- Rotate to shift the center frequency of the receiver's IF passband.
- Rotate clockwise to shift the center frequency higher, or counterclockwise to shift the center frequency lower.

8 LOCK SWITCH [LOCK]

- ➔ Push momentarily to turn the Dial Lock function ON or OFF. (p. 19)
- The Dial Lock function electronically locks the main dial.

9 MAIN DIAL

- Rotate to change the displayed frequency, selects Quick/Initial set mode items, and so on.

10 PREAMP SWITCH [P.AMP] (p. 21)

- Push momentarily to turn the preamp ON or OFF.

11 CH SWITCH [CH] (p. 35)

- Push momentarily to turn the Memory Channel Select function ON or OFF.
- [MEMO] blinks while the Memory Channel Select function is turned ON.
- Push one or more times (or hold down)[▼ DN]/[UP ▲] until a desired Memory channel appears.
- After pushing [F-INP/ENT], push a desired Memory channel number from the keypad, then push [F-INP/ENT] again to directly select the Memory Channel.
- Push [CH] to exit the Memory Channel Select function.

12 MEMORY CHANNEL (BAND) UP/DOWN SWITCHES [▼ DN]/[UP ▲] (p. 35)

- ➔ Push one or more times to select a Memory channel, while “MEMO” is blinking.
- ➔ Push to select a band.
- ➔ Push to select an item in the Quick/Initial Set mode.

13 ATTENUATOR SWITCH [ATT] (p. 22)

Push to turn the 20 dB Attenuator function ON or OFF.

14 TUNER SWITCH [TUNER] (pp. 29, 30)

- ➔ Push to turn the Automatic Antenna Tuner function ON or OFF.
 - An optional antenna tuner must be connected.
- ➔ Hold down for 1 second to manually start the tuner.
 - An optional antenna tuner must be connected.
 - When the tuner cannot tune the antenna within 20 seconds, the tuning circuit is automatically bypassed.

15 SET SWITCH [SET]

- ➔ Hold down for 1 second to enter the Quick Set mode. (p. 41)
- ➔ While holding down [SET], push [POWER] to enter the Initial Set mode. (p. 41)
- ➔ Push to select the Meter function. (p. 28)
 - PO: Displays the relative RF output power.
 - ALC: Displays ALC level.
 - SWR: Displays the SWR over the transmission line.

16 MIC COMPRESSOR SWITCH [COMP] (p. 28)

Toggles the Microphone Compressor function ON or OFF.

17 KEYPAD (pp. 4, 35)

The keypad can be used for direct frequency input, Memory channel selection, or secondary functions.

18 NOISE BLANKER SWITCH [NB] (p. 22)

- ➔ Push to turn the Noise Blanker ON or OFF. The Noise Blanker reduces pulse-type noise such as that generated by automobile ignition systems. This function is not effective against non pulse-type noise.
- ➔ Hold down [NB] for 1 second to enter the Noise Blanker Level Setting mode.

19 QUICK TUNING STEP SWITCH [TS] (pp. 18, 19)

- ➔ Selects a Quick Tuning step or turns OFF the Quick Tuning step.
 - While the Quick Tuning icon (“▼”) is displayed, the frequency is changed in kHz step.
- ➔ While the Quick Tuning step is OFF, hold down for 1 second to turn the 1 Hz step ON or OFF.
 - A 1 Hz indication appears and the frequency is changed in 1 Hz steps.
- ➔ While the kHz Quick Tuning step is selected, hold down for 1 second to enter the Tuning Step Set mode.

20 FILTER SWITCH [FIL] (p. 24)

Push to select the preset normal, wide, or narrow IF filters for the selected operating mode.

21 MODE SWITCHES [LSB/USB]/[CW/CW-R]/[RTTY/RTTY-R]/[AM] (p. 20)

Push to select an operating mode.

- In the SSB mode, holding down [MODE] for 1 second toggles between LSB and USB.
- In the CW mode, holding down [MODE] for 2 seconds toggles between CW and CW Reverse.
- In the RTTY mode, holding down [MODE] for 2 seconds toggles between RTTY and RTTY Reverse.
- “REV” appears when the Reverse mode is selected.

■ Front panel (continued)

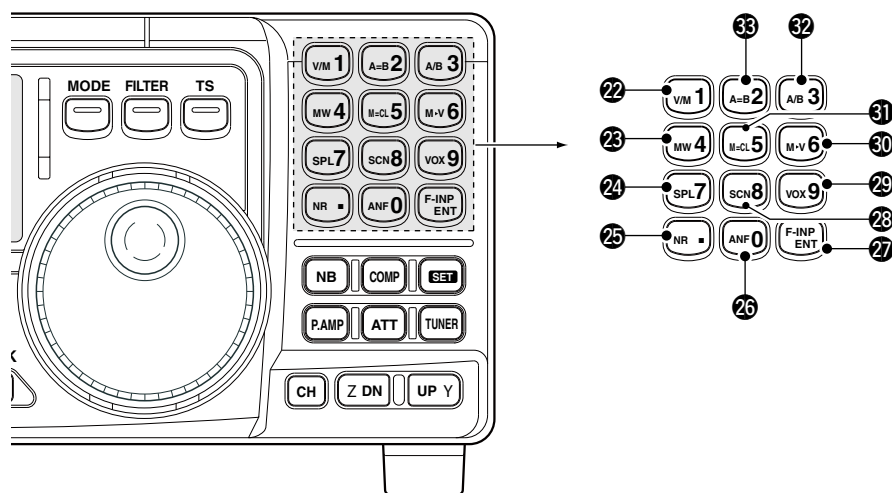

22 VFO/MEMORY SWITCH/1 [V/M•1] (pp. 16, 35)
 Push to toggle the operating mode between VFO and Memory.

23 MEMORY WRITE SWITCH/4 [MW•4] (p. 36)
 Hold down for 1 second to enter the displayed frequency and operating mode into the selected Memory channel.

24 SPLIT SWITCH/7 [SPL•7] (p. 26)
 Push to turn the Split Frequency function ON or OFF.

25 NR SWITCH/. [NR•.] (p. 23)
 ➔ Push to turn the Noise Reduction function ON or OFF. This function can be used in all modes.
 • An optional UT-106 DSP UNIT is required.
 • “NR” appears on the display.
 ➔ Hold down for 1 second to enter the Noise Reduction Level Set mode.

26 ANF SWITCH/0 [ANF•0] (p. 23)
 Push to turn the Automatic Notch Filter function ON or OFF.
 This function can be used in SSB and AM modes.
 • An optional UT-106 DSP UNIT is required.
 • “ANF” appears on the display.

27 FREQUENCY INPUT/ENTER SWITCH [F-INP/ENT]
 ➔ Push [F-INP/ENT] to enter the Direct Frequency Input mode.
 ➔ After pushing [CH], push [F-INP/ENT] to enter the Direct Memory Number Selection mode.

28 SCAN SWITCH/8 [SCAN•8] (p. 39)
 ➔ Push to start or stop the Programmed Scan in the VFO mode.
 ➔ Push to start or stop the Memory Scan in the Memory mode.

29 VOX SWITCH/9 [VOX•9] (p. 28)
 In the SSB modes, push to turn the VOX function ON or OFF.

30 M▶V SWITCH/6 [MV•6] (p. 37)
 Hold down for 1 second to copy the memory contents to the VFO.

31 MEMORY CLEAR SWITCH/5 [M=CL•5] (p. 38)
 In the Memory mode, hold down for 1 second to clear the selected Memory channel contents.
 • “BLANK” appears above the Memory channel number.

32 VFO SELECT SWITCH/3 [A/B•3] (p. 16)
 ➔ In the VFO mode, push to toggle between VFO A and VFO B.
 ➔ When the Split Frequency function is ON, push to toggle between the transmit and the receive frequency.

33 VFO EQUALIZATION SWITCH/2 [A=B•2]
 Push to equalize the VFO B frequency and operating mode to the VFO A frequency and operating mode.

■ Function display

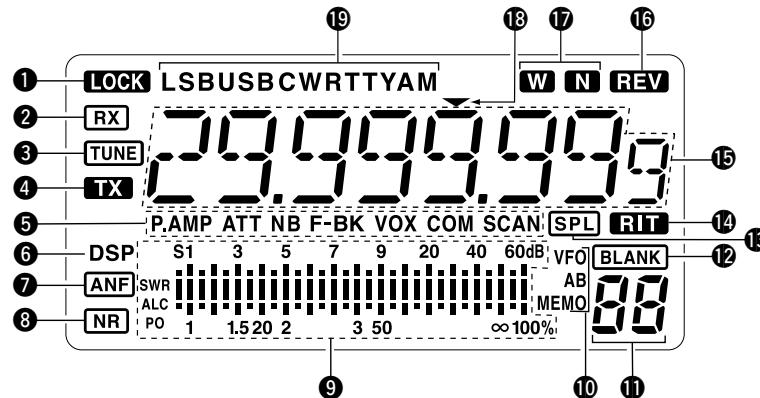

- 1 LOCK ICON** (p. 19)
Displayed when the Dial Lock function is in use.
- 2 RECEIVE ICON**
Displayed while receiving a signal or when the squelch is open.
- 3 TUNE ICON**
Displayed while the Automatic Tuning function is in use.
- 4 TRANSMIT ICON**
Displayed while transmitting.
- 5 FUNCTION ICONS**
 - ➔ “P.AMP” is displayed when antenna preamp is in use.
 - ➔ “ATT” is displayed when the Attenuator function is in use.
 - ➔ “NB” is displayed when the Noise Blanker function is ON.
 - ➔ “BK” is displayed when the Semi Break-in function is selected in Quick Set mode.
 - ➔ “F-BK” is displayed when the Full Break-in function is selected in the CW mode. (p. 31)
 - ➔ “VOX” is displayed when the VOX function is selected in the Quick Set mode.
 - ➔ “COM” is displayed when the speech compressor is ON in the SSB mode.
 - ➔ “SCAN” is displayed when the Scan function is in use.
 - Blinks when a scan is paused.
- 6 DSP UNIT ICON**
Displayed when an optional UT-106 DSP UNIT is installed.
- 7 AUTOMATIC NOTCH FILTER ICON** (p. 23)
Displayed when the optional Automatic Notch Filter function is in use.
- 8 NOISE REDUCTION ICON** (p. 23)
Displayed when the optional Noise Reduction function is in use.
- 9 SIGNAL/SQL/RF-GAIN METER**
 - ➔ Displays the signal strength while receiving.
 - ➔ Displays the relative output power, ALC, or SWR levels while transmitting. (p. 27)
- 10 VFO/MEMORY ICON** (p. 16)
“VFO A” or “VFO B” is displayed when the VFO mode is selected.
“MEMO” is displayed when the Memory mode is selected.
- 11 MEMORY CHANNEL NUMBER READOUT** (p. 35)
Displays the selected Memory channel number.
- 12 BLANK ICON** (p. 38)
Indicates that the selected Memory channel has no content.
 - This icon appears both in VFO and Memory mode.
- 13 SPLIT ICON** (p. 26)
Displayed when the Split function is ON.
- 14 RIT ICON** (p. 21)
Displayed when the RIT function is in use.
- 15 FREQUENCY READOUT**
Displays the operating frequency.
- 16 REVERSE ICON** (p. 20)
Displayed when the CW reverse or RTTY reverse mode is selected.
- 17 WIDE/NARROW FILTER ICONS** (pp. 24, 25)
 - ➔ “W” is displayed when the wide IF filter is selected.
 - ➔ “N” is displayed when the narrow IF filter is selected.
- 18 PROGRAMMABLE TUNING STEP ICON**
Displayed when you select the programmable tuning step.
- 19 MODE ICONS** (p. 20)
Displays the selected operating mode.

■ Rear panel

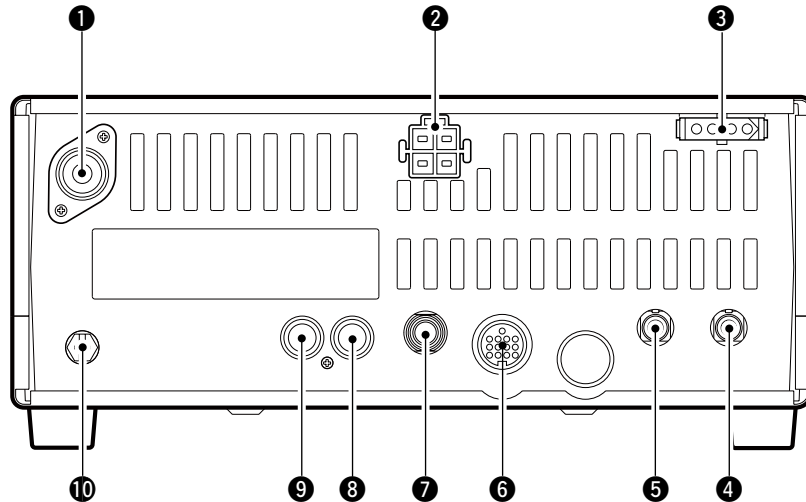

1 ANTENNA CONNECTOR [ANT] (p. 10)
Connects to a 50 Ω antenna with a PL-259 plug connector and a 50 Ω coaxial cable.

2 DC POWER SOCKET [DC 13.8V] (p. 12)
Connects to a 13.8 V DC source through the supplied DC power cable.

Rear panel view

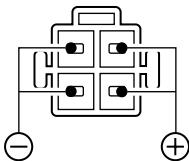

3 TUNER CONTROL SOCKET [TUNER] (p. 14)
Connects to the control cable from an optional AH-4 AUTOMATIC ANTENNA TUNER.

4 CI-V REMOTE CONTROL JACK [REMOTE] (p. 57)
Connects to a PC for remote control of the of transceiver functions.

5 EXTERNAL SPEAKER JACK [EXT SP] (p. 11)
Connects to an 8 Ω external speaker.
• When an external speaker is connected, the internal speaker is disabled.

6 ACCESSORY SOCKET [ACC] (p. 7)
Connects to external equipment such as a linear amplifier, an automatic antenna tuner, a TNC for data communications, and so on.

7 ELECTRONIC KEYS JACK [KEY]
Accepts a key or paddle connector for the internal electronic keyer.
• You can select the keyer type between the internal electronic keyer and straight key operation in the Initial Set mode.

When connecting a straight key

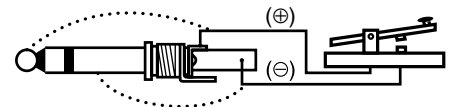

When connecting a paddle

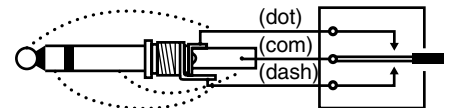

8 ALC INPUT JACK [ALC]
Connects to the ALC output jack of a non-Icom linear amplifier.

9 SEND CONTROL JACK [SEND] (p. 14)
Goes to ground while transmitting to control external equipment such as a liner amplifier.
• Maximum control level: 16 V DC/2 A

10 GROUND TERMINAL [GND] (p. 9)
Connects to ground to prevent electrical shock, TVI, BCI and other problems.

◇ ACC SOCKET INFORMATION

• ACC socket

ACC	PIN #	NAME	DESCRIPTION	SPECIFICATIONS
 <p>Rear panel view</p>	1	8 V	Regulated 8 V output.	Output voltage: 8 V ±0.3 V Output current: Less than 10 mA
	2	GND	Connects to ground.	—
	3	SEND	Input/output pin. Goes to ground when transmitting. When grounded, transmits.	Ground level: -0.5 V to 0.8 V Input current: Less than 20 mA
	4	BDT	Data line for the optional AT-180.	—
	5	BAND	Band voltage output. (Varies with amateur band)	Output voltage: 0 to 8.0 V
	6	ALC	ALC voltage input.	Control voltage: -4 to 0 V Input impedance: More than 10 kΩ
	7	NC	—	—
	8	13.8 V	13.8 V output when power is ON.	Output current: Maximum 1 A
	9	TKEY	Key line for the AT-180.	—
	10	FSKK	RTTY keying input.	Ground level: -0.5 to 0.8 V Input current: Less than 10 mA
	11	MOD	Modulator input.	Input impedance: 10 kΩ Input level: Approx. 100 mV rms
	12	AF	AF detector output. Fixed, regardless of [AF] position.	Output impedance: 4.7 kΩ Output level: 100 to 300 mV rms
	13	SQL S	Squelch output. Goes to ground when squelch opens.	SQL open: Less than 0.3 V/5 mA SQL closed: More than 6.0 V/100 μA

• When connecting the ACC conversion cable (OPC-599)

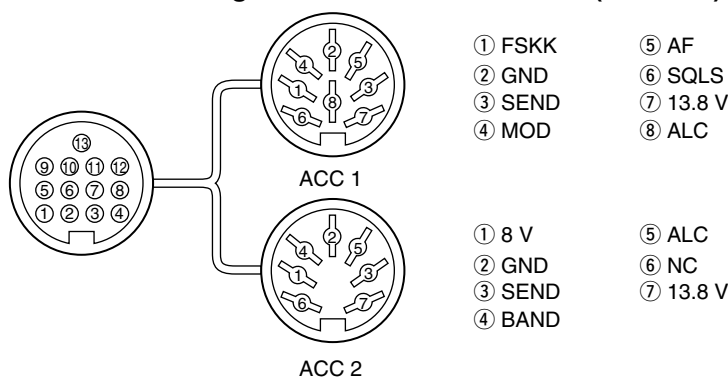

When the SEND terminal controls an inductive load (such as a relay), a counter-electromotive force can cause the transceiver to malfunction or other damage. To prevent this, we recommend adding a switching diode, such as an “1SS133,” on the load side of the circuit to the counter-electromotive force absorption. When the diode is added, a switching delay of the relay may occur. Be sure to check its switching action before operation.

[Example]

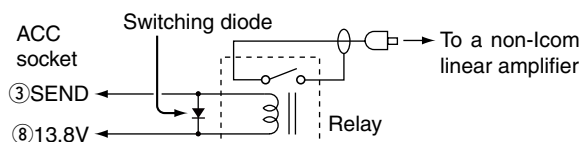

2 PANEL DESCRIPTION

■ Microphone (HM-36)

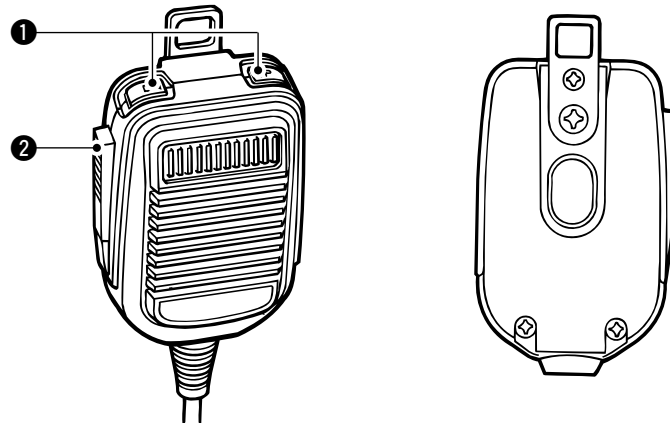

1 UP/DOWN SWITCHES [UP]/[DN]

Change the selected readout frequency or Memory channel.

- Holding down continuously changes the frequency or Memory channel number.
- The [UP]/[DN] switch can simulate a key paddle. Preset in CW PADDL in the Initial Set mode. (p. 31)

2 PTT SWITCH

Push to transmit, release to receive.

• MICROPHONE CONNECTOR

(Front view)

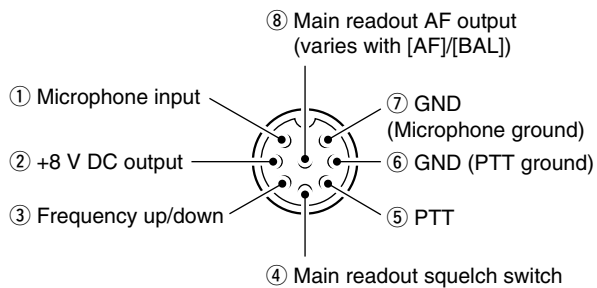

[MIC] PIN NO.	FUNCTION	DESCRIPTION
2	+8 V DC output	Maximum 10 mA
3	Frequency up	Ground
	Frequency down	Ground through 470 Ω
4	Squelch open	"LOW" level
	Squelch close	"HIGH" level

CAUTION: DO NOT short pin 2 to ground as this can damage the internal 8 V regulator. DC voltage is also applied to pin 1 for microphone operation. Use caution when using a non-Icom microphone.

• HM-36 SCHEMATIC DIAGRAM

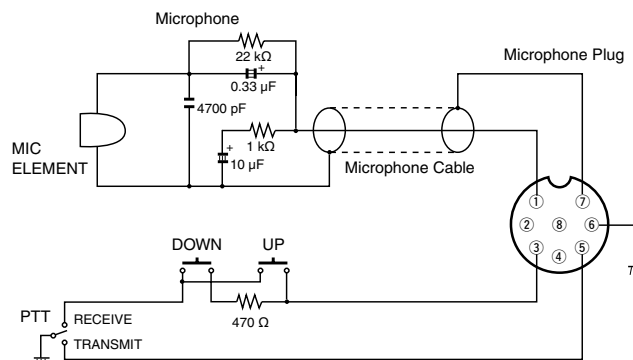

■ Unpacking

After unpacking, immediately report any damage to the delivering carrier or dealer. Keep the shipping cartons.

For a description and a diagram of accessory equipment included with the IC-718, see 'Supplied accessories' on page 1 of this manual.

■ Selecting a location

Select a location for the transceiver that allows adequate air circulation, free from extreme heat, cold, or vibrations, and away from TV sets, TV antenna elements, radios and other electromagnetic sources.

The base of the transceiver has an adjustable stand for desktop use. Set the stand to one of two angles to suit your operating conditions.

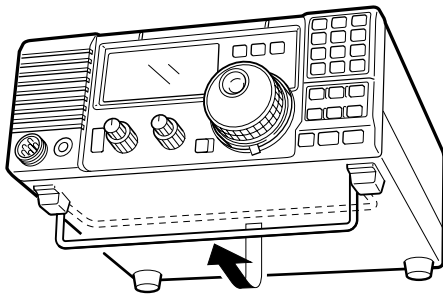

■ Grounding

To prevent electrical shock, television interference (TVI), broadcast interference (BCI) and other problems, ground the transceiver through the GROUND terminal on the rear panel.

For best results, connect a heavy gauge wire or strap to a long earth-sunk copper rod. Make the distance between the [GND] terminal and ground as short as possible.

⚠ WARNING! NEVER connect the [GND] terminal to a gas or electric pipe, since the connection could cause an explosion or electric shock.

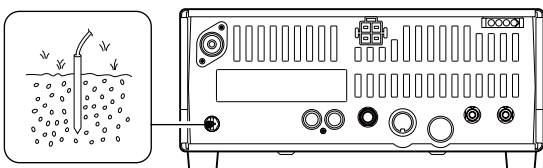

■ Connecting an antenna

For radio communications, the antenna is of critical importance, along with output power and receiver sensitivity. Select antenna(s), such as a well-matched 50 Ω antenna, and feedline. A Voltage Standing Wave Ratio (VSWR) of 1.5:1 or less is recommended for your desired band.

NOTE: A lightning arrestor may offer some protection from static electricity.

Antenna SWR

Each antenna is tuned for a specified frequency range and SWR may increase out of that range. When the SWR is higher than approximately 2.0:1, the transceiver's power drops to protect the final transistor. In this case, an antenna tuner is useful to match the transceiver and antenna. The IC-718 has an SWR meter to continuously monitor the antenna SWR.

3 INSTALLATION AND CONNECTIONS

■ Required connections

• Front panel (Microphone)

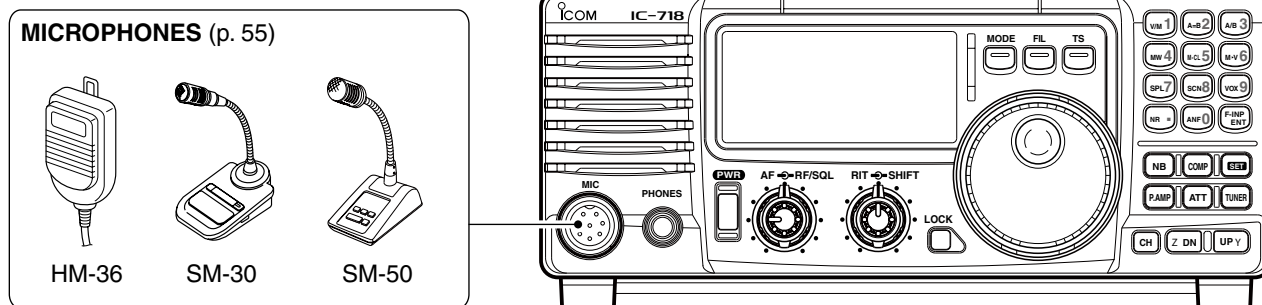

• Rear panel (Basic connection)

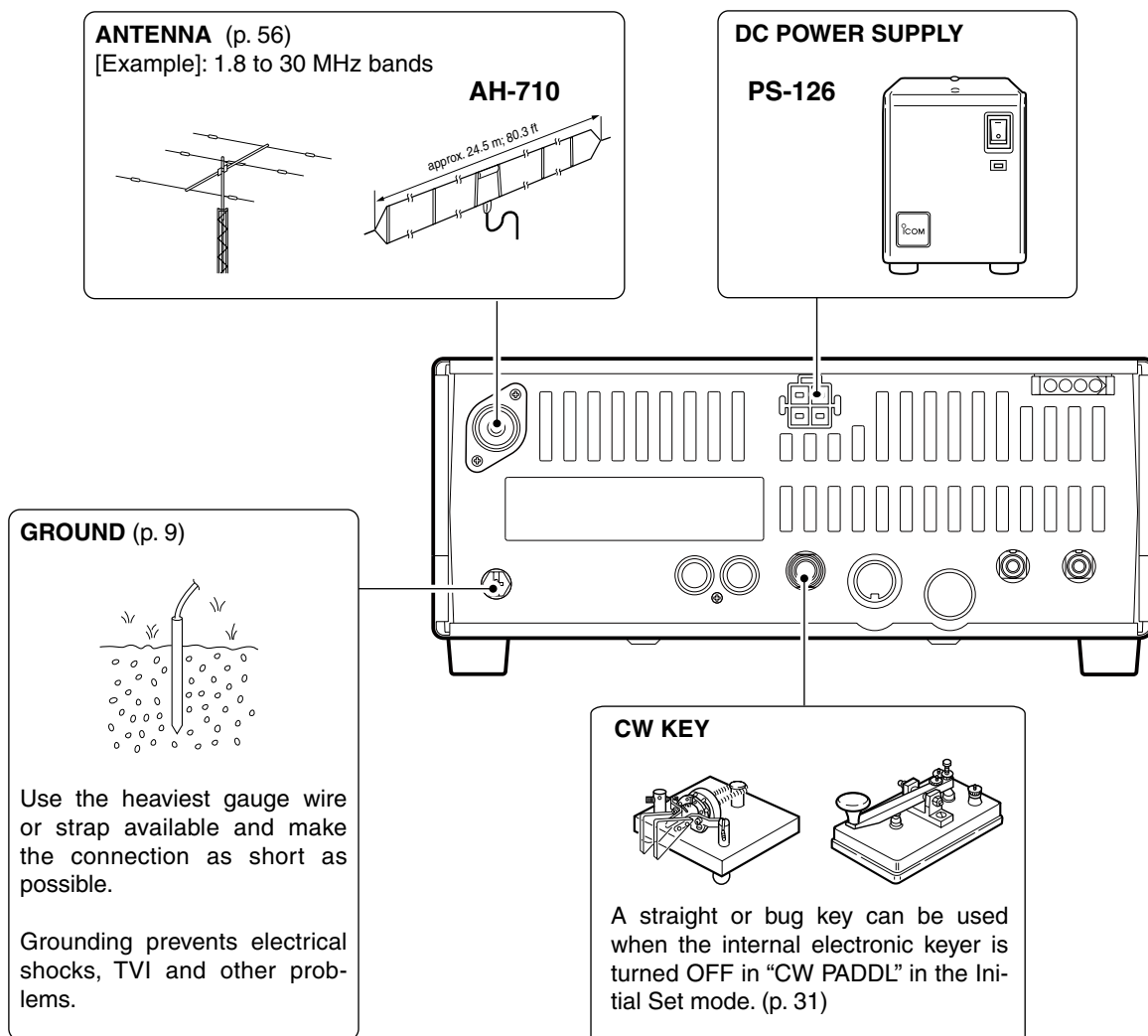

■ Advanced connections

• Front panel (Microphone and headphones)

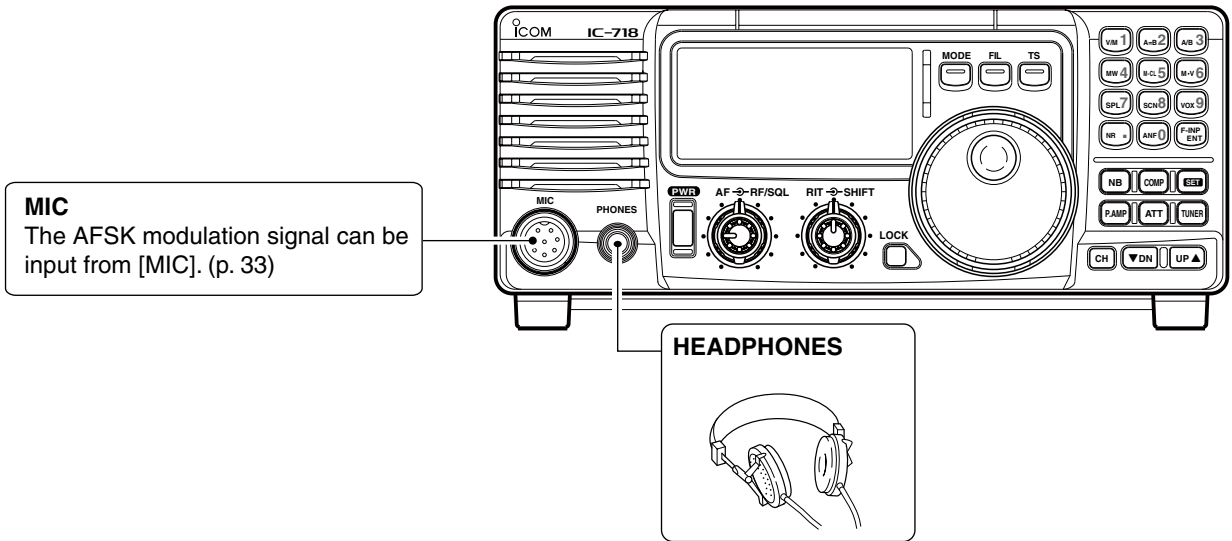

• Rear panel (Optional products and external equipment)

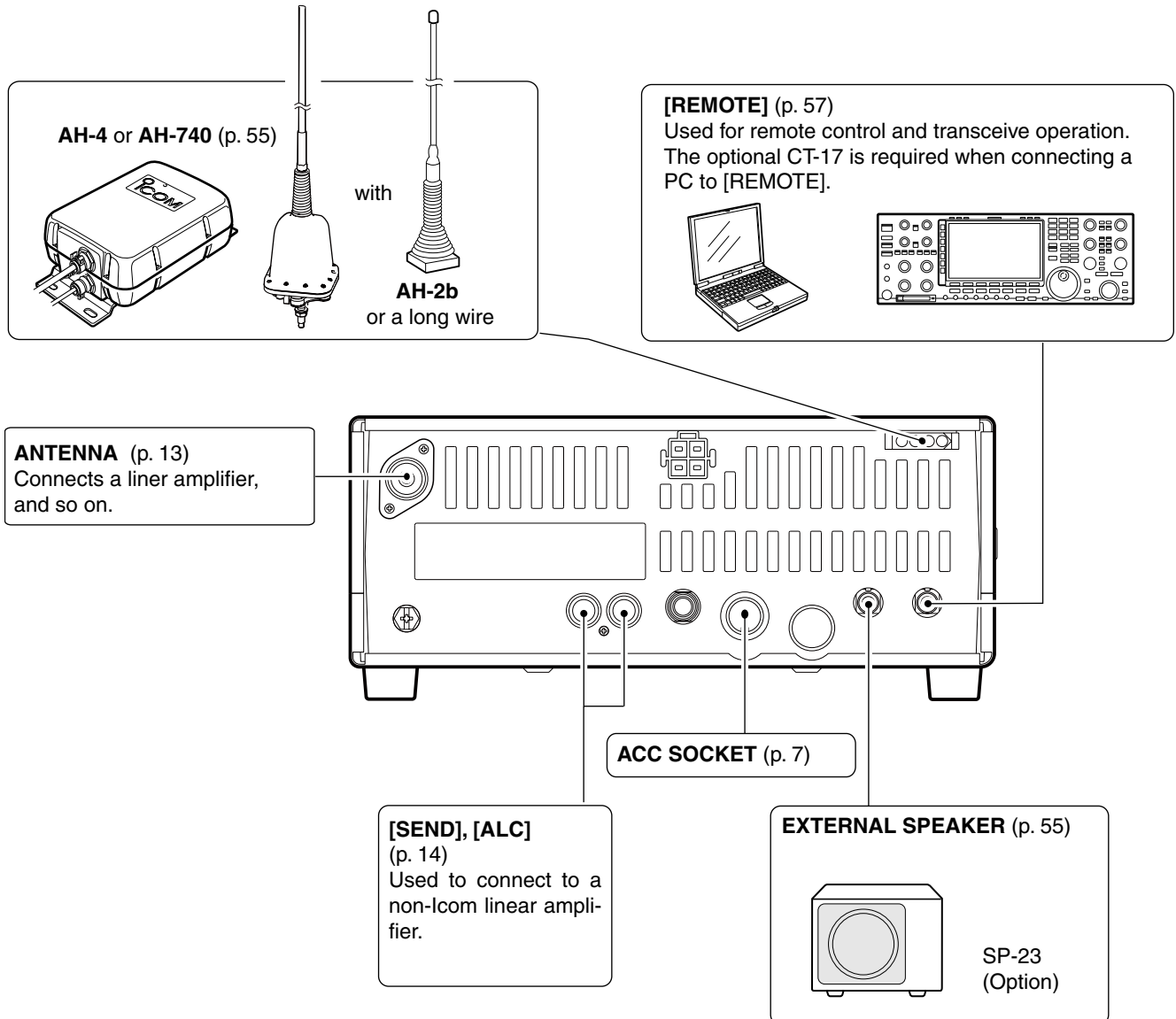

3 INSTALLATION AND CONNECTIONS

■ Connecting the Power supply

Use an optional PS-126 DC POWER SUPPLY when operating the IC-718 with AC power. Refer to the diagrams below.

CAUTION: Before connecting the DC power cable, check the following important items. Make sure:

- The [POWER] switch is OFF.
- Output voltage of the power source is 12 to 15 V when you use a non-Icom power supply.
- DC power cable polarity is correct.
Red: Positive ⊕ terminal
Black: Negative ⊖ terminal

CONNECTING THE PS-126 DC POWER SUPPLY

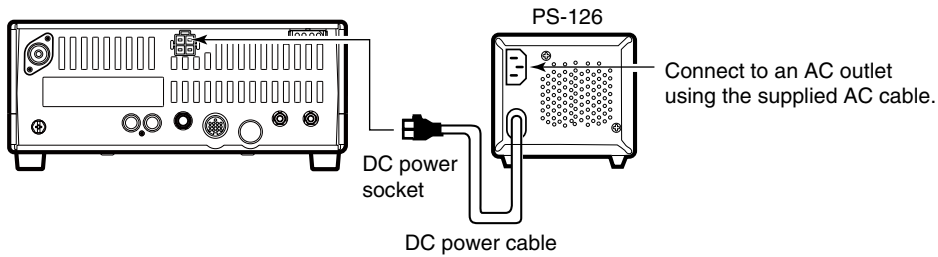

CONNECTING A NON-ICOM DC POWER SUPPLY

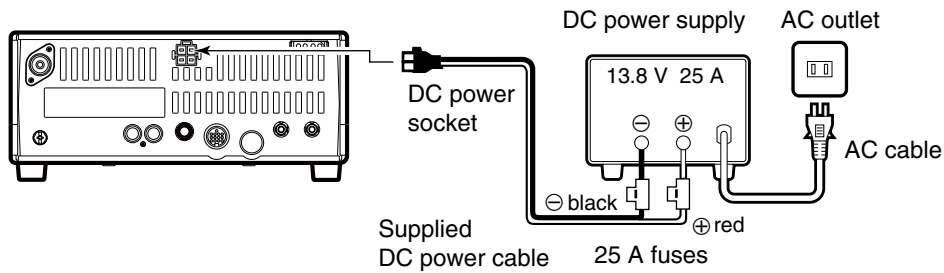

CONNECTING A VEHICLE BATTERY

- **⚠ WARNING! NEVER** connect to a battery without using a DC fuse, otherwise a fire hazard could occur or damage to the transceiver.
- **NEVER** connect the transceiver to a 24 V battery.

The transceiver may not receive well on some frequencies when installed in a hybrid vehicle, or any type of electric vehicle (fuel cell vehicle). This is because vehicle's electric components, such as the inverter system, generate a lot of electric noise.

- **DO NOT** use a cigarette lighter socket as a power source when operating in a vehicle. The plug may cause voltage drops and ignition noise may be superimposed onto transmit or receive audio.
- Use a rubber grommet when passing the DC power cable through a metal plate to prevent a short circuit.

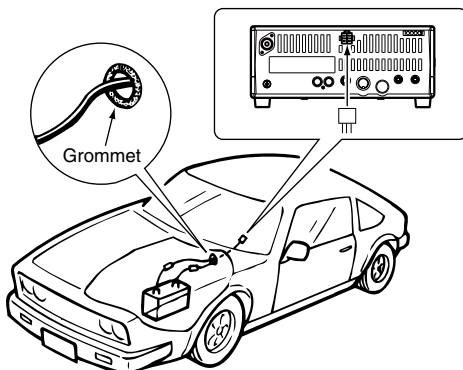

NOTE: Use terminals for the cable connections.

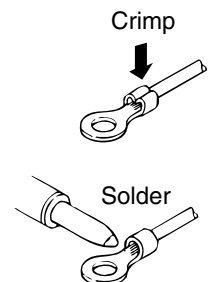
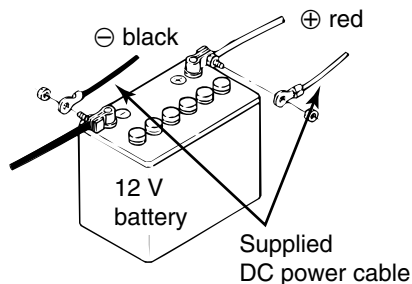

■ Connecting a linear amplifier

CONNECTING THE IC-PW1/EURO

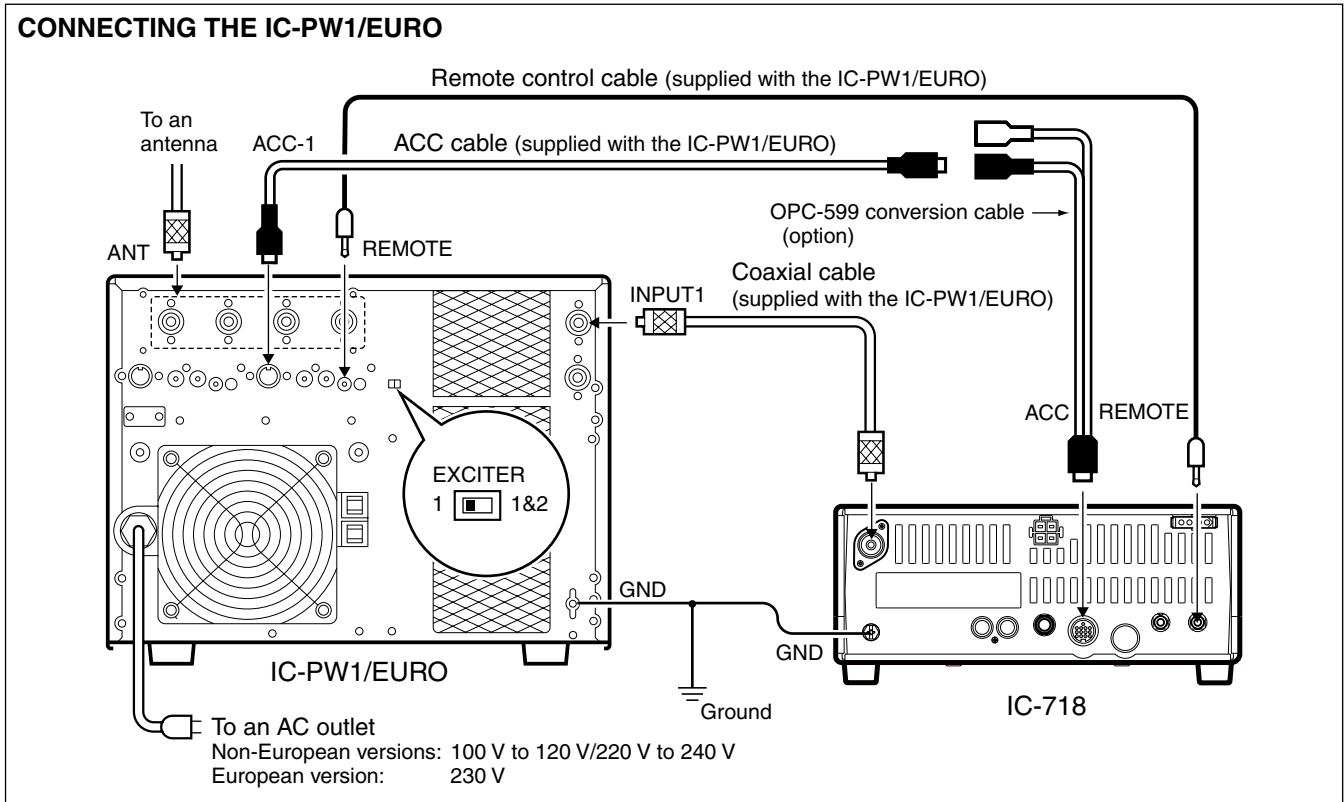

CONNECTING A NON-ICOM LINER AMPLIFIER

⚠ WARNING!

Set the transceiver output power and linear amplifier ALC output level referring to the linear amplifier instruction manual.

The ALC input level must be in the range 0 V to -4 V. The transceiver does not accept a positive voltage. Non-matched ALC and RF power settings could cause a fire or ruin the linear amplifier.

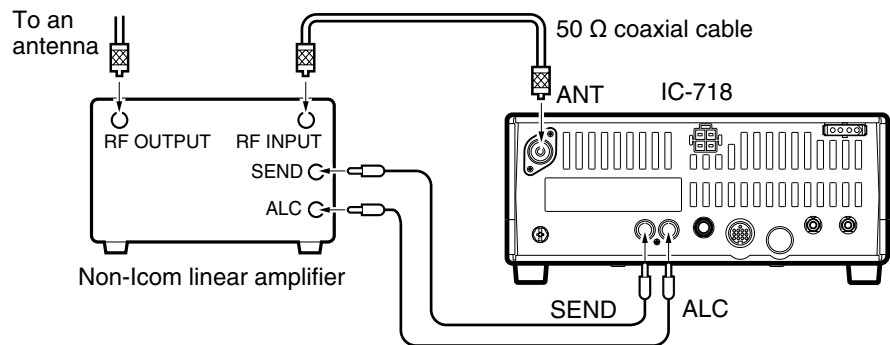

The specifications for the SEND relay are 16 V DC 2 A. If this level is exceeded, a large external relay must be used.

3 INSTALLATION AND CONNECTIONS

External antenna tuners

CONNECTING THE AH-4 (p. 30)

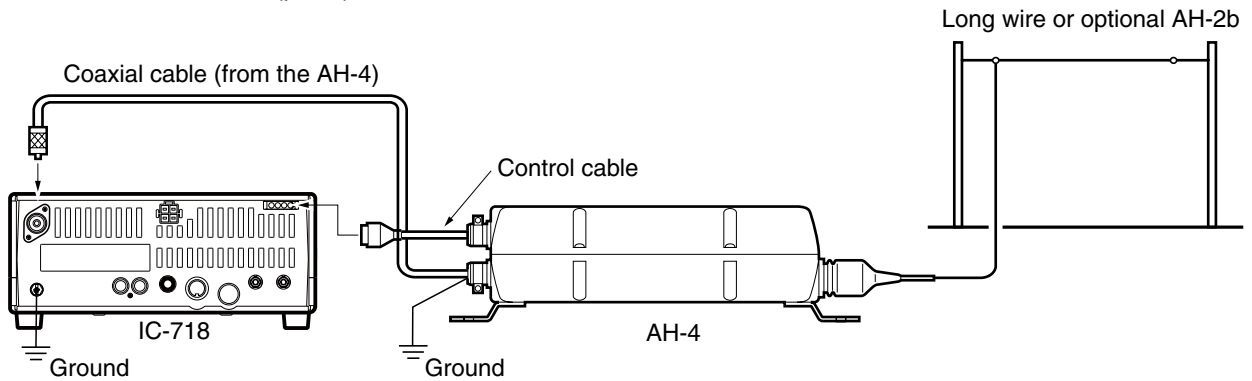

CONNECTING THE AH-740 (p. 30)

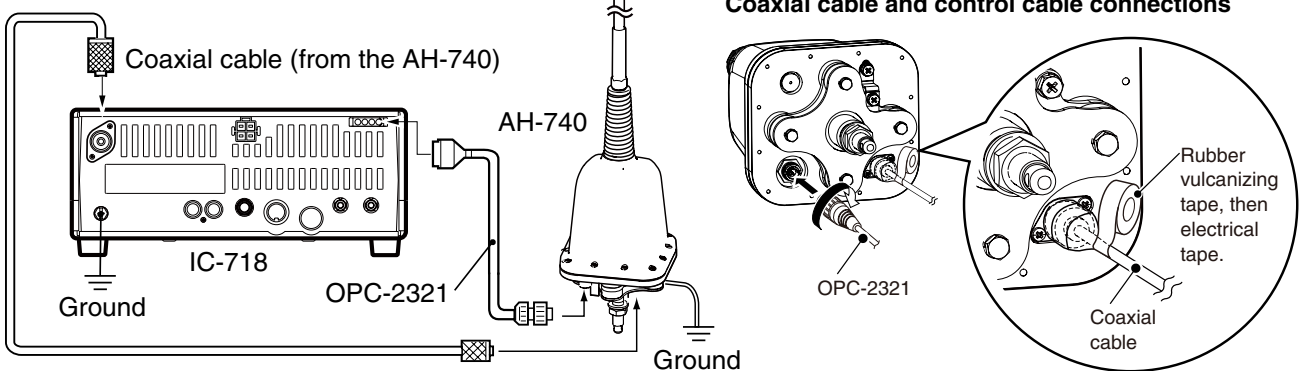

About the ground strap connection

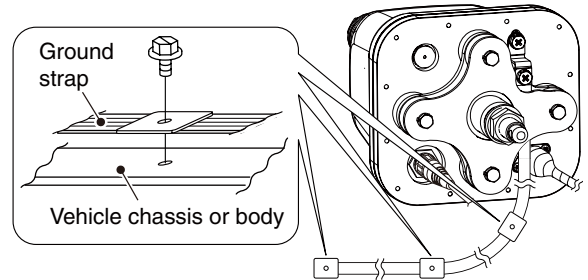

- The coaxial cable is supplied with the AH-740. The OPC-2321 Control cable is optional.
- See the AH-740 instruction manual for the installation and connection details.

CONNECTING THE AT-180 (p. 29)

DO NOT connect an AT-180 and AH-4 or AH-740 at the same time. Both tuners will not function correctly.

When connecting the AT-180, turn OFF the IC-718's power, otherwise, the CPU may malfunction and the AT-180 may not function properly.

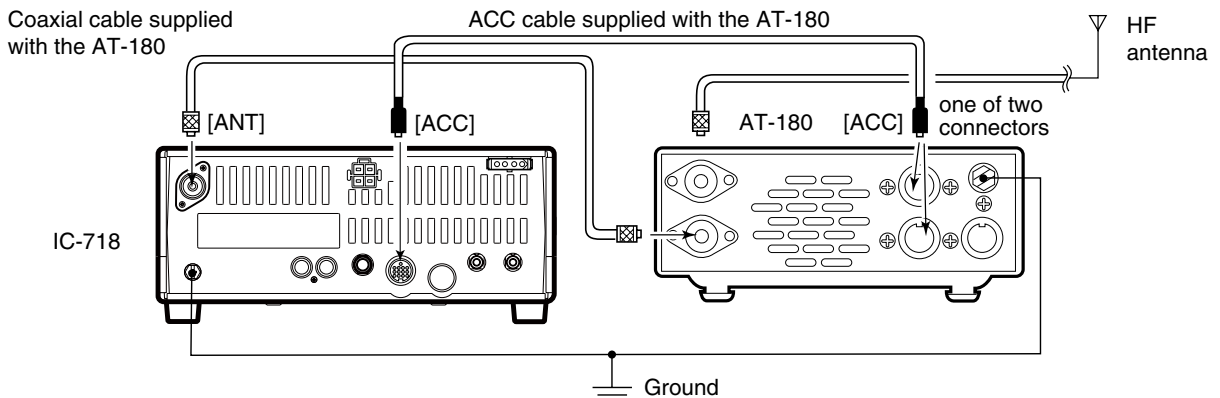

■ Resetting the CPU

Before first applying power, make sure all connections required for your system are complete by referring to Chapter 3. Then, reset the transceiver using the following procedure.

/// A resetting **CLEARs** all Memory channel programming and returns all Quick Set mode and Initial Set mode settings to their factory defaults.

- ① Make sure the transceiver power is OFF.
- ② While holding down [UP ▲] and [▼ DN], hold down [PWR] for 1 second to turn ON the power.
 - The internal CPU is reset.
 - The transceiver displays its initial VFO frequencies when resetting is complete.
- ③ All Quick Set mode and Initial Set mode settings are returned to their default values. (p. 41)

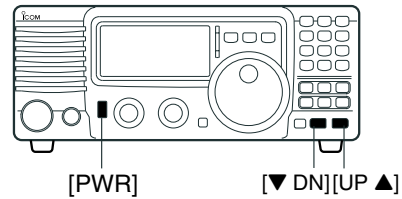

/// In cooler temperatures, the LCD may appear dark and unstable after turning ON the power. This is normal and does not indicate any equipment malfunction.

■ Initial settings

After resetting the transceiver, set the controls and switches as shown in the figure below.

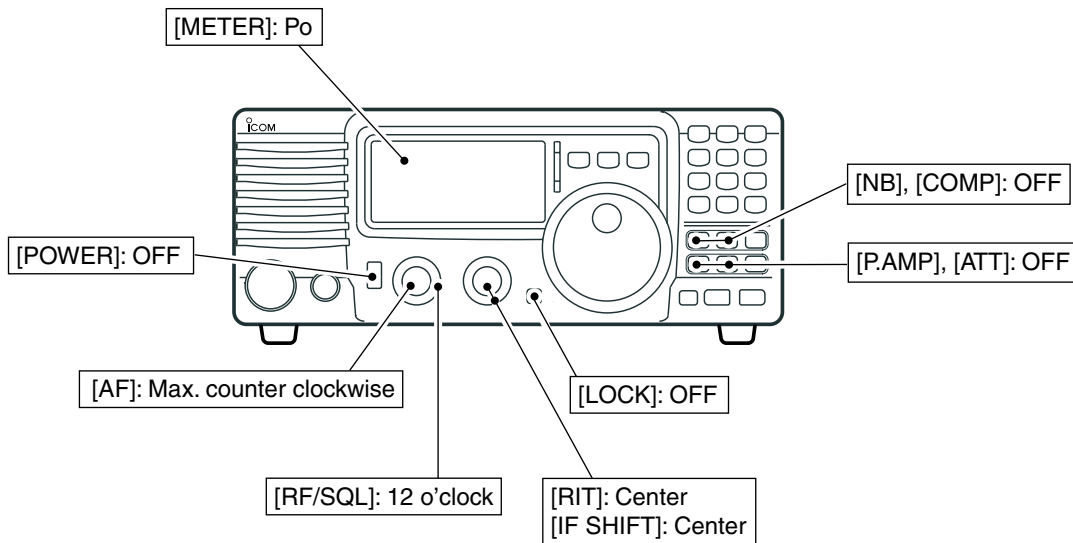

Turn ON the power, then check the display. If any of the following icons appear, turn them OFF as follows.

- Quick tuning step icon ("▼"): Push [TS].
- 1 Hz frequency readout: Hold down [TS] for 1 second.
(When Quick Tuning step is OFF.)
- RIT icon ("RIT"): Set the [RIT] control to the center position.
- Split icon ("SPL"): Push [SPL].

■ VFO description

VFO is an abbreviation of Variable Frequency Oscillator, and traditionally refers to an oscillator.

The IC-718 VFOs can store frequencies and operating modes

You can set a desired frequency in the VFO with the [MAIN DIAL], the keypad or the Memory Copy function. (p. 37) You can also select the operating mode with the [MODE] switch or call up previously accessed frequencies and modes with the Band Stacking Register. (p. 18)

The IC-718 has two VFOs, VFO A and VFO B, especially suited for split frequency operation. You can easily use an operating frequency.

• Differences between the VFO mode and the Memory mode

VFO MODE

Each VFO displays a frequency and operating mode. If the frequency or mode is changed, the VFO automatically memorizes the new frequency or mode.

When you select a VFO, the last used frequency and mode appear, even if another frequency or mode is selected in another VFO or Memory channel.

[EXAMPLE]

VFO is selected.

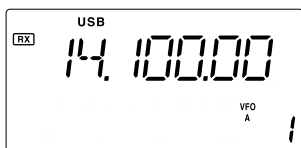

The frequency is changed.

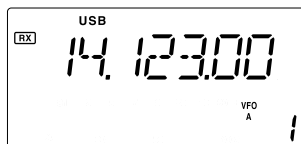

Memory mode is selected.

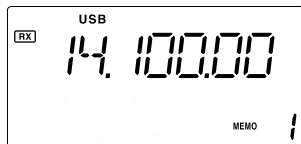

VFO is selected again.

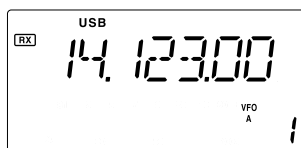

Last used frequency (14.123 MHz) appears.

MEMORY MODE (pp. 35–38)

Each Memory channel shows a frequency and operating mode like a VFO. Even if the frequency or mode is changed, the Memory channel does not memorize the new frequency or mode.

When you select the Memory channel, the memorized frequency and mode appear, even if the frequency or mode is changed in the memory, then another memory or VFO is selected.

[EXAMPLE]

Memory channel 1 is selected.

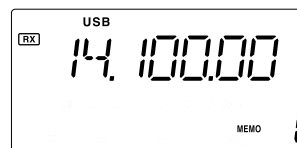

The frequency is changed.

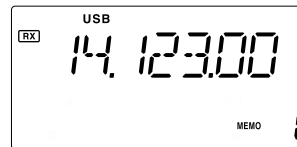

Another Memory channel is selected.

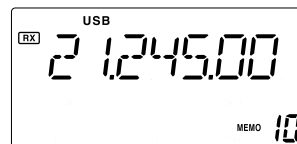

Memory channel 1 is selected again.

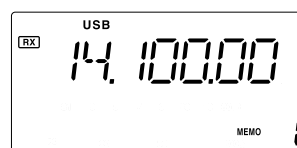

Memorized frequency (14.100 MHz) appears instead of the changed frequency (14.123 MHz).

■ Frequency setting

◇ Using [MAIN DIAL]

- ① Push [UP ▲] or [▼ DN] one or more times to select a desired ham band.

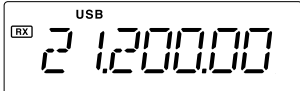

- ② Push [MODE] one or more times to select a desired operating mode. (p. 20)

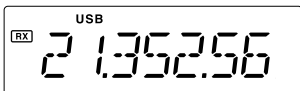

- ③ Rotate [MAIN DIAL] to set an operating frequency.

• For general coverage receiver use

The IC-718 has a general coverage receiver band.

- ① Push [UP ▲] or [▼ DN] one or more times to select the general coverage receiver band.

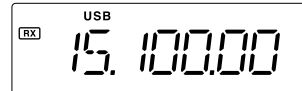

NOTE: Even if you select a ham band, you can select a general coverage frequency. When the displayed frequency exits the transmit frequency range (ham band), a band edge beep may sound, depending on the presetting.

◇ Entering a frequency from the keypad

The transceiver has a keypad for direct frequency entry.

- ① Push [F-INP/ENT].
- ② Enter an operating frequency with the numeric keys on the keypad.

- Push [.] to enter “.” (decimal point) between the MHz and kHz digits.
 - To cancel the input, push [SET] (or any key except a keypad key).
 - When you enter the same MHz digits as the displayed frequency, the step ② can be skipped.
- ③ Push [F-INP/ENT] to set the entered frequency.
 - When you push [F-INP/ENT] after entering the MHz digits, zeros are automatically entered for the kHz digits.

[EXAMPLE]

•Start

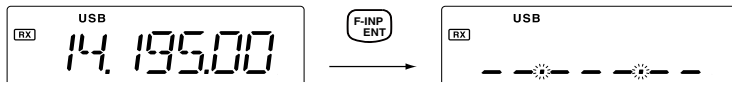

•To enter 21.025 MHz

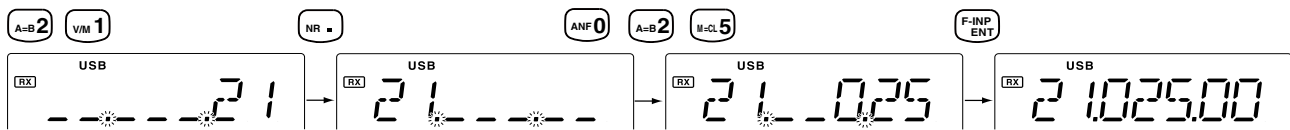

•To enter 706 KHz (0.706 MHz)

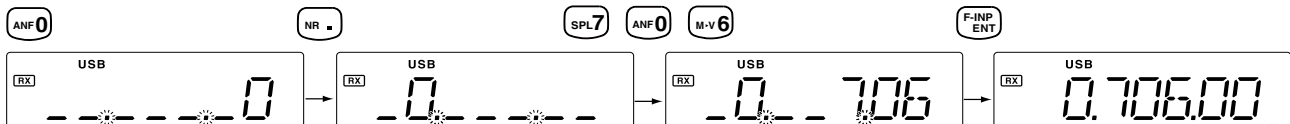

•To enter 7 MHz

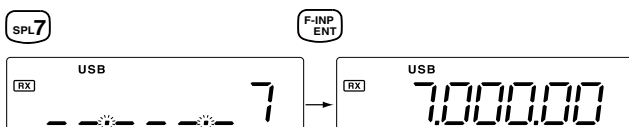

•To change 14.195 to 14.850 MHz

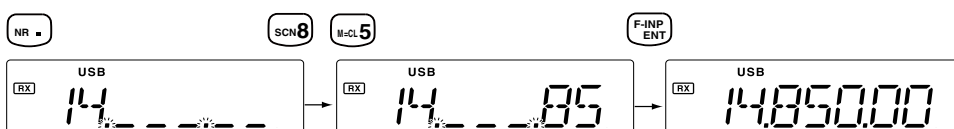

4 FREQUENCY SETTINGS

◇ Band Stacking Register

The Band Stacking Register automatically stores the last used frequency and operating mode for each band.

See the table below for a list of the bands available and the default settings for each register.

BAND	BAND	BAND
1.9 MHz	1.91000 MHz	CW
3.5 MHz	3.55000 MHz	LSB
7 MHz	7.05000 MHz	LSB
10 MHz	10.12000 MHz	CW
14 MHz	14.10000 MHz	USB
General	15.10000 MHz	USB

BAND	BAND	BAND
18 MHz	18.10000 MHz	USB
21 MHz	21.20000 MHz	USB
24 MHz	24.95000 MHz	USB
28 MHz	28.50000 MHz	USB
29 MHz	29.50000 MHz	USB

◇ Band selection

All HF ham bands and a general coverage receiver band are included in the IC-718.

- ➔ Push [UP ▲] or [▼ DN] to select a desired band.
 - Holding down [UP ▲] or [▼ DN] continuously scrolls through the selectable bands.

NOTE: For example, if 6.10000 MHz is registered as the General coverage frequency, the General coverage band automatically positions itself between 3.5 MHz and 7 MHz band.

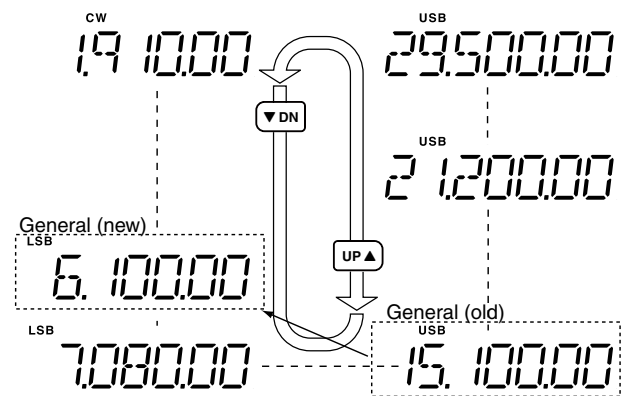

◇ Programmable tuning steps

Select the tuning step to suit your operating requirements.

- 0.1, 1, 5, 9, 10, 100 kHz are selectable

- ① Push [TS] to turn ON the Quick tuning function.
 - “▼” appears.
- ② Hold down [TS] for 2 seconds to enter the Tuning Step Set mode.
- ③ Rotate [MAIN DIAL] to select a desired tuning step.
 - 0.1, 1, 5, 9, 10, or 100 kHz are selectable.
- ④ Push [TS] to exit the mode.
- ⑤ Rotate [MAIN DIAL] to change the frequency according to the set tuning step.
- ⑥ Push [TS] to turn OFF the Quick tuning function.
 - “▼” disappears.

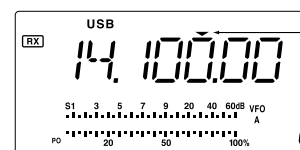

Programmable tuning step indicator

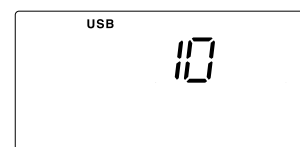

10 kHz tuning steps is selected.

◇ 1 Hz and 10 Hz tuning steps

When the programmable tuning step, “▼,” disappears, rotating [MAIN DIAL] changes the frequency in increments of 1 or 10 Hz.

- ① Push [TS] one or more times until “▼” disappears.
- ② Hold down [TS] for 1 second to toggle between the 1 Hz and 10 Hz step settings.
 - When the 1 Hz step is selected, the 1 Hz digit appears in the frequency readout.
 - When the 10 Hz step is selected, the 1 Hz digit disappears from the frequency readout.

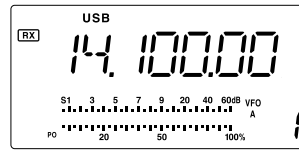

Rotating [MAIN DIAL] changes the frequency in 10 Hz steps.

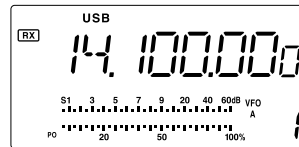
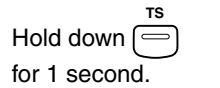

Rotating [MAIN DIAL] changes the frequency in 1 Hz steps.

[TS] SWITCH FLOW CHART

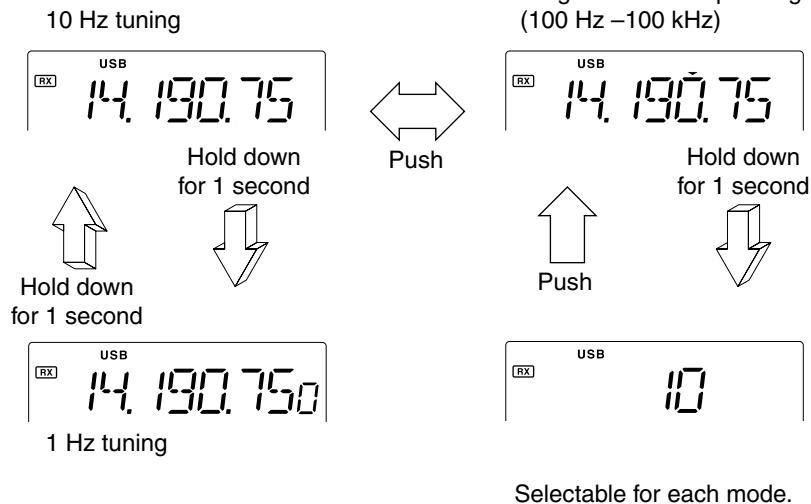

■ Dial Lock function

The Dial Lock function electronically locks [MAIN DIAL].

- ➔ Push [LOCK] to turn the function ON or OFF.
 - “LOCK” appears when the function is ON.

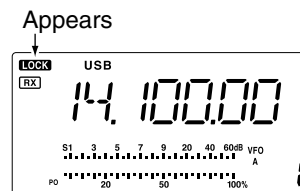

Mode selection

You can use the following modes in the IC-718: SSB (LSB/USB), CW, CW REV (CW reverse), RTTY, RTTY REV (RTTY reverse) and AM.

- ➔ Push [MODE] one or more times to select the desired operating mode.
- ➔ Hold down [MODE] for 1 second to toggle between USB and LSB. (SSB mode only)
- ➔ Hold down [MODE] for 1 second to toggle between CW and CW reverse or RTTY and RTTY reverse. (CW and RTTY mode only)
- The selected mode is displayed in the Function Display.

Note: If desired mode cannot be selected, it may be inhibited by the Initial Set mode. (p. 44)

OPERATING MODE SELECTION

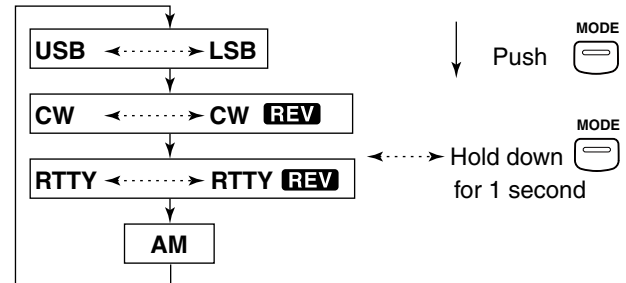

RF gain and Squelch

The IC-718 uses the same control, [RF/SQL], to adjust either the RF gain or the squelch, depending on the operating mode selected and the setting of the RF/SQL item in Initial Set mode (p. 44).

• [RF/SQL] control priority

Set mode setting	USB, LSB, CW, RTTY	AM
rS (RF/SQL) (default)	RF/SQL	RF/SQL
At (AUTO)	RF GAIN	SQL*
Sq (SQL)	SQL*	SQL*

* The RF gain is set to maximum level when [RF/SQL] is set as [SQL] control.

- Shallow rotation moves the S-meter to the right indicating the signal strength which can be received.

/// We recommend setting the RF Gain control to the 12 o'clock position since this sets RF gain to the maximum.

The *SQUELCH* removes noise output from the speaker (closed condition) when no signal is received. The squelch is selectable in all modes.

- Segments appear in the S-meter to indicate the S-meter squelch level.

• When set as the [RF/SQL] control

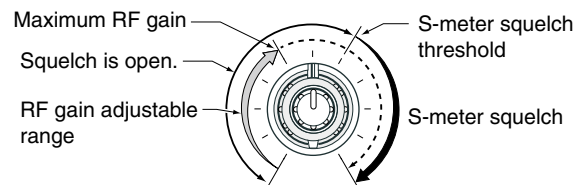

• When set as the [SQL] control

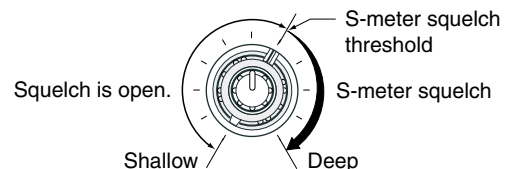

• When set as the [RF] control

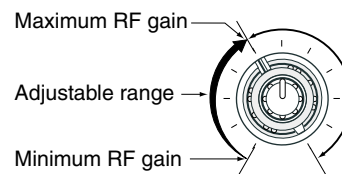

■ Function for receive

◇ IF shift function

The IF shift function electronically narrows the passband frequency of the intermediate frequency (IF) and cuts out higher or lower frequency components of the IF to reject interference. The function shifts the IF frequency up to ± 1.2 kHz in the SSB/CW/RTTY modes and up to ± 250 Hz in the CW-narrow/RTTY narrow modes. The IF shift is not selectable in the AM mode.

IF SHIFT OPERATION EXAMPLE

- Adjust the [SHIFT] control for minimum interference.
- When IF shift is used, the audio tone may change.
- Set the IF shift control to the center position when there is no interference.

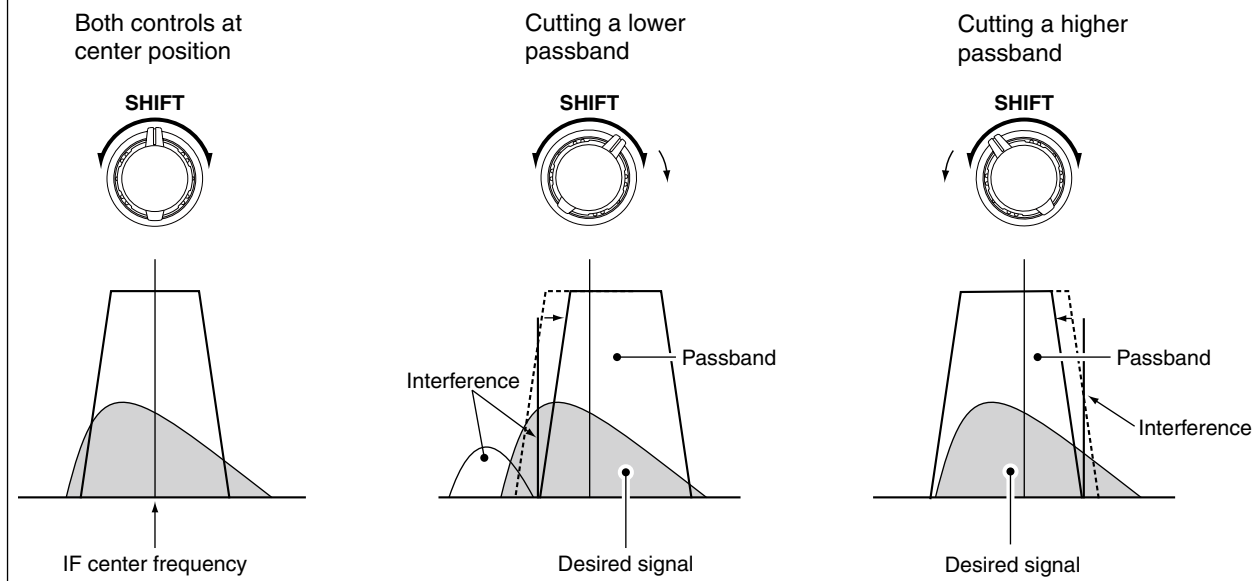

◇ RIT function

The Receive Incremental Tuning (RIT) function compensates for off-frequency signals. The function shifts the receive frequency up to 1.2 kHz without shifting the transmit frequency.

- ① Rotate the RIT control to shift the off-frequencies.
 - "RIT" appears on the display.
 - The transmit frequency is not shifted.

- ② To cancel the RIT function, rotate the RIT control to the center position.
 - "RIT" disappears.

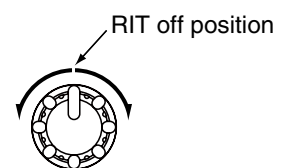

◇ Preamp

The preamp amplifies received signals in the front end circuit to improve the signal to noise (S/N) ratio and sensitivity. Turn this function ON when receiving weak signals.

- ➔ Push [P.AMP] to turn the preamp ON or OFF.
 - The preamp functions below 1.59999 MHz, but sensitivity may be reduced.

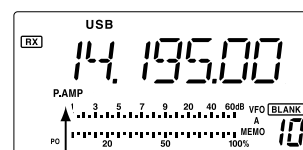

Appears when the preamp ON.

5 RECEIVE AND TRANSMIT

◇ Attenuator

The attenuator prevents desired signals from distorting when the receive signal is very strong or when very strong electric fields, such as from broadcasting stations, are near your location.

- ➔ Each push of [ATT] toggles the 20 dB attenuator function ON or OFF.
- “ATT” appears when the attenuator is ON.

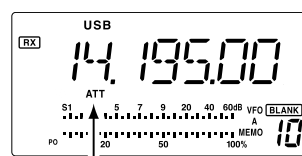

Appears when the attenuator is ON.

◇ Noise Blanker

The Noise Blanker (NB) reduces pulse-type noise such as that generated by automobile ignition systems.

- ① Push the [NB] switch to turn the noise blanker ON or OFF.
 - ② Hold down [NB] for 1 second to enter the noise blanker level Set mode.
 - ③ Rotate [DIAL] to adjust the noise blanker level.
 - ④ Push [NB] to exit the Set mode.
 - ⑤ Push [NB] again to turn the noise blanker function OFF.
- “NB” disappears.

- ▨ When using the noise blanker, received signals may be distorted if they are excessively strong.
- ▨ The noise blanker function in the AM mode can be turned ON or OFF in the initial set mode setting. (p. 45)

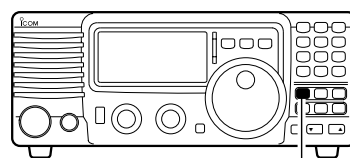

[NB] switch

◇ Meter peak hold

The meter peak hold function keeps the highest displayed bar segment in any meter function for about 0.5 seconds so that you can read the meter indication easier. This function can be turned ON or OFF in the initial Set mode (p. 45).



Initial reception of a signal results in an S-meter reading of 40 dB over 9.

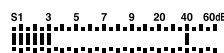

The highest indicated bar remains displayed for 0.5 seconds even when the signal strength decreases.

■ DSP function (Requires an optional UT-106 DSP UNIT)

◇ NR (Noise Reduction) function

When an optional UT-106 is installed, the Noise Reduction function can be used. Also, DSP appears in the Function display.

The Noise Reduction function reduces noise components and picks out desired signals that are buried in noise. The received AF signals are converted to digital signals and then the desired signals are separated from the noise.

- ① Push [NR] to turn the noise reduction ON.
 - “NR” appears.

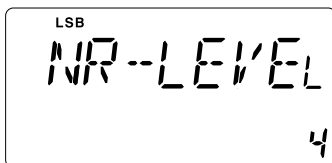

- ② Hold down [NR] for 1 second to enter the Noise Reduction level Set mode.
- ③ Rotate [DIAL] to adjust the Noise Reduction level.
- ④ Push [NR] to exit the Set mode.
- ⑤ Push [NR] again to turn the function OFF.
 - “NR” disappears.

• Noise Reduction example

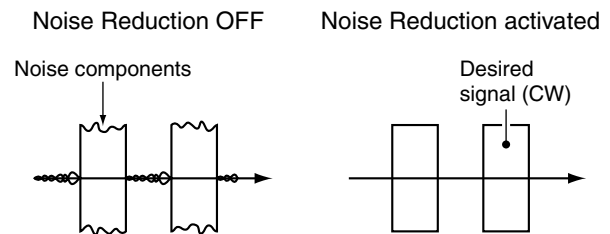

Higher setting of the [NR] level results in audio signal masking or distortion. Set the [NR] level for maximum clarity. The Noise Reduction function is usable in all modes.

◇ ANF (Automatic Notch Filter) function

When an optional UT-106 is installed, the auto notch function can be used. Also, DSP appears in the Function display.

The function automatically attenuates more than 3 beat tones, tuning signals and so on, even if they are moving.

The auto notch functions in only the SSB mode.

- ① Select the SSB mode.
- ② Push [ANF] to turn ON the Auto Notch function.
 - “ANF” appears.
- ③ Push [ANF] again to turn OFF the function.
 - “ANF” disappears.

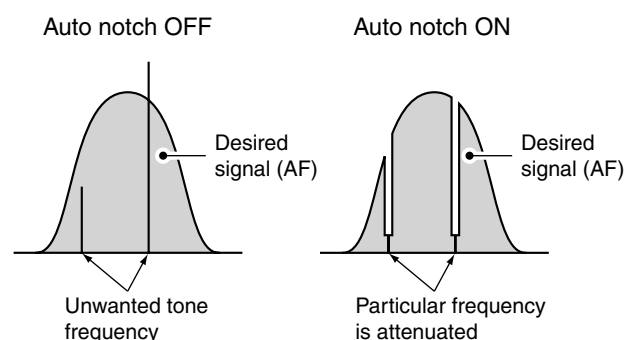

Filter selection

The filter selection adjusts the IF bandpass width, as shown in the table to the right. The filter selection is automatically memorized in each mode.

- ① Select the desired mode with the mode keys.
- ② Push [FIL] one or more times to select the desired filter combination.
 - **N** or **W** does not appear while in the normal IF filter mode.
 - **W** appears when the wide IF filter is selected.
 - **N** appears when the narrow IF filter is selected.

When an optional filter is installed, set the optional filter in the initial Set mode. An optional filter is not selected by default.

Optional filter variations

Name	Band width	Mode
FL-52A†	500 Hz/−6 dB	CW/RTTY-N
FL-53A†	250 Hz/−6 dB	CW/RTTY-N
FL-96†	2.8 kHz/−6 dB	SSB-W
FL-222	1.8 kHz/−6 dB	SSB-N
FL-257	3.3 kHz/−6 dB	SSB-W

The narrower band width is for higher receive selectivity.

Filter image

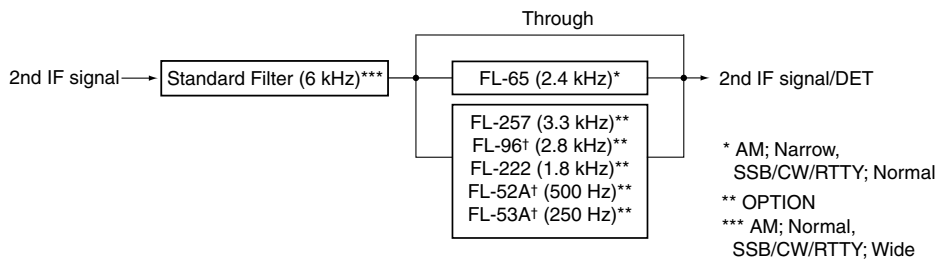

Filter selection table

		No Optional Filter	FL-52A†	FL-53A†	FL-96†	FL-222	FL-257
SSB	WIDE	6 k*	6 k*	6 k*	6 k* 2.8 k	6 k*	6 k* 3.3 k
	NORMAL	2.4 k	2.4 k	2.4 k	2.4 k	2.4 k	2.4 k
	NARROW	/	500*	250*	/	1.8 k	/
CW	WIDE	6 k*	6 k*	6 k*	6 k* 2.8 k	6 k*	6 k* 3.3 k
	NORMAL	2.4 k	2.4 k	2.4 k	2.4 k	2.4 k	2.4 k
	NARROW	/	500	250	/	1.8 k	/
RTTY	WIDE	6 k*	6 k*	6 k*	6 k* 2.8 k	6 k*	6 k* 3.3 k
	NORMAL	2.4 k	2.4 k	2.4 k	2.4 k	2.4 k	2.4 k
	NARROW	/	500	250	/	1.8 k	/
AM	WIDE	/	/	/	/	/	/
	NORMAL	6 k	6 k	6 k	6 k	6 k	6 k
	NARROW	2.4 k	2.4 k 500*	2.4 k 250*	2.4 k 2.8 k*	2.4 k 1.8 k*	2.4 k 3.3 k*

(Hz)

Note: *This selection can be used when the expanded filter selection function is turned ON in the initial Set mode. (see right)

†No longer produced

Filter setting

When an optional filter is installed, set the optional filters in the initial Set mode. Optional filters are not selected by default. (p. 47)

Optional filter setting

- ① While holding down [SET], push [POWER] to enter the initial Set mode.
- ② Push [UP ▲] or [▼ DN] one or more times until "FIL" appears on the display.
- ③ Rotate [DIAL] to select a desired filter.
 - "no," "52A," "53A," "96," "222" and "257" indicate no optional filter.
 - FL-52A, FL-53A, FL-96, FL-222 and FL-257 indicate the respective for 455 kHz IF filter selection.
- ④ Push [PWR] to exit the initial Set mode, and turn OFF the transceiver.

Expanded filter selection

The selectable filter combinations can be expanded by setting the expanded filter selection to ON. Then an extra wide or narrow filter can be selected in desired modes.

- ① While holding down [SET], push [PWR] to enter the initial Set mode.
- ② Push [UP ▲] or [▼ DN] one or more times until "EXP FIL" appears.
- ③ Rotate [DIAL] to turn ON the expanded filter selection.
 - When ON set, the expanded filter selection can be used.

Wide/narrow filter selecting

- ④ Push [UP ▲] one or more times until "WIDE **" or "NAR **" is displayed.
- ⑤ Push [MODE] one or more times to select the desired mode.
- ⑥ Rotate [DIAL] to select a filter.
- ⑦ Repeat steps ⑤ and ⑥ to select IF filters for other modes, if desired.
 - The filter combinations are stored according to each operating mode.
- ⑧ Push [POWER] to exit initial set mode and turn OFF the transceiver.

Optional filter selection

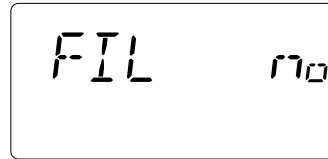

Expanded filter selection "on"

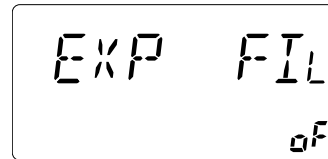

Wide filter setting

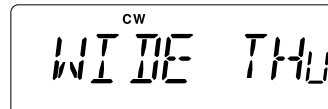

Narrow filter setting

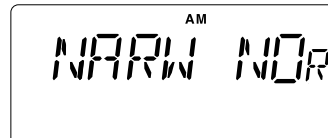

Wide filter setting table

	No Optional Filter	FL-52A†	FL-53A†	FL-96†	FL-222	FL-257
SSB	no	no	no	96 (2.8 k)	no	257(3.3 k)
	THU (6 k)	THU (6 k)	THU (6 k)	THU (6 k)	THU (6 k)	THU (6 k)
CW	no	no	no	96 (2.8 k)	no	257(3.3 k)
	THU (6 k)	THU (6 k)	THU (6 k)	THU (6 k)	THU (6 k)	THU (6 k)
RTTY	no	no	no	96 (2.8 k)	no	257(3.3 k)
	THU (6 k)	THU (6 k)	THU (6 k)	THU (6 k)	THU (6 k)	THU (6 k)
AM	---	---	---	---	---	---

□ : default

Narrow filter setting table

	No Optional Filter	FL-52A†	FL-53A†	FL-96†	FL-222	FL-257
SSB	---	no	no	---	222 (1.8 k)	---
		52A (500)	53A (250)			
CW	---	52A (500)	53A (250)	---	222 (1.8 k)	---
RTTY	---	52A (500)	53A (250)	---	222 (1.8 k)	---
AM	NOR (2.4 k)	NOR (2.4 k)	NOR (2.4 k)	NOR (2.4 k)	NOR (2.4 k)	NOR (2.4 k)

□ : default

- See the filter construction diagram on page 24 for "THU (through)."
- "no," "52A," "53A," "96," "222" and "257" indicate no optional filter.

†No longer produced

5 RECEIVE AND TRANSMIT

■ Split frequency operation

Split frequency operation allows you to transmit and receive on two different frequencies. Split frequency operation uses two frequencies, one in VFO A and the other in VFO B.

The following is an example of setting 7.057 MHz, CW mode in VFO A (for receive) and 7.025 MHz, CW mode in VFO B (for transmit).

- ① Select VFO B and set the frequency to 7.025 MHz/CW.
- ② Push [A/B] to select VFO A and set the frequency to 7.057 MHz/CW.
- ③ Push [SPL] to turn ON the split frequency operation.
 - Split operation is now set for receive 7.057 MHz/CW and transmit 7.025 MHz/CW.
 - To change the receive frequency, rotate the main dial, to change the transmit frequency, rotate the main dial in the transmit mode.

To exchange the transmit and receive frequencies, push [A/B].

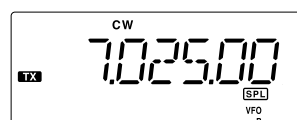
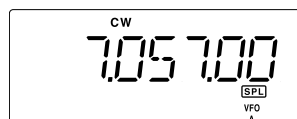

■ SWR

The IC-718 has a built-in circuit to measure antenna SWR— no external equipment or special adjustments are necessary.

◇ Measuring SWR

- ① Confirm that the output power is over 30 W.
- ② Push [SET] one or more times to select the SWR meter.
- ③ Push [MODE] one or more times to select the CW or RTTY operation.
 - Key down or push [PTT] to transmit, then read the actual SWR from the meter:
 - ≤ 1.5 well matched antenna
 - ≥ 1.5 check antenna or cable connection and so on.

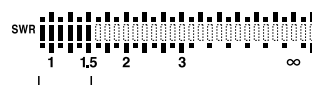

The best match is in this range.

■ Function for transmit

◇ Output power and microphone gain

• Setting the output power

- ① Hold down [SET] for 1 second to select the Quick Set mode.
- ② Push [UP ▲]/[▼ DN] one or more times to select "RF Power."
- ③ Rotate the main dial to select the desired output.
 - Output power is continuously selectable in 101 steps (L, 1–99 and H).
- Available power
 - SSB/CW/RTTY: 2 (or less) – 100 W
 - AM: 2 (or less) – 35 W*
- *Carrier power

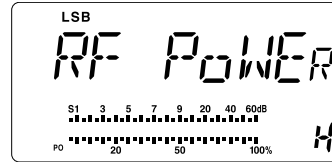

Maximum output power is selected.

• Setting the microphone gain

Microphone gain must be adjusted properly so that your transmit signal is not distorted.

- ① Select SSB or another phone mode.
- ② Hold down [SET] for 1 second to enter the Quick Set mode.
- ③ Push [UP ▲]/[▼ DN] one or more times to select "MIC GAIN."
- ④ Speak into the microphone at your normal voice level and adjust the mic gain so that the ALC meter does not peak past the ALC zone.
- ⑤ Push [SET] to exit Quick Set mode.

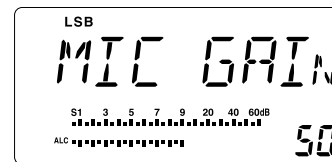

Microphone gain is set to 50.

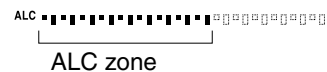

◇ Meter function

The bar meter in the function display acts as an S-meter (for relative signal strength) during receive, and can be set to one of three functions during transmit.

- Push [SET] one or more times to select the PO, ALC and SWR meter mode.

DISPLAY INDICATION	MEASUREMENT
Po	Indicates the relative RF output power.
ALC	Indicates the ALC level. When the meter movement shows the input signal level exceeds the allowable level, the ALC limits the RF power. In such cases, reduce the microphone gain (see above).
SWR	Indicates the SWR over the transmission line.

5 RECEIVE AND TRANSMIT

◇ Microphone compressor

The IC-718 has a built-in, low distortion mic compressor circuit. This circuit increases your average talk power in the SSB mode, and is especially useful for DX'ing when the receiving station is having difficulty receiving your signal.

- ① Select USB or LSB mode.
- ② Select the mic gain display in the Quick Set mode.
 - Hold down [SET] for 1 second to select the Quick Set mode.
 - Push [UP ▲]/[▼ DN] one or more times to select "MIC GAIN."
- ③ Adjust the mic gain by rotating [DIAL].
 - While speaking at your normal voice level, the ALC meter should read about the middle of the ALC zone.
 - Be sure the mic gain is in the range of 20 to 50.
- ④ Push [SET] to exit the Quick Set mode.
- ⑤ Push [COMP] to turn the mic compressor ON.
- ⑥ Push [SET] one or more times to select the ALC meter.
- ⑦ While speaking into the microphone at your normal voice level, confirm the ALC level so that the ALC meter peak does not past the ALC zone.
 - If the ALC meter peak past the ALC zone, readjust the mic gain.

Note: If the ALC meter peaks above the ALC zone, your transmitted voice may be distorted.

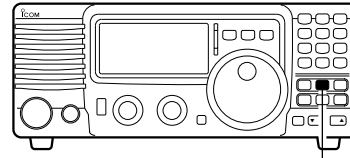

[COMP] switch

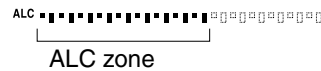

Adjust [MIC GAIN] so that the ALC meter reads within the ALC zone.

◇ VOX operation

The VOX (Voice-operated Transmission) function toggles between transmit and receive with your voice. This function also allows you an opportunity to input log entries into your computer and so on, while operating.

- ① Push [VOX] to turn the function ON.
- ② Select "VOX Gain" in the Quick Set mode.
 - Hold down [SET] for 1 second to select the Quick Set mode.
 - Push [UP ▲]/[▼ DN] one or more times to select "VOX GAIN."
- ③ While speaking at your normal voice level, adjust [VOX GAIN] until the transceiver is transmitting.
- ④ Select "VOX Delay" in the Quick Set mode.
 - Push [UP ▲]/[▼ DN] one or more times to select "VOX Delay."
- ⑤ While speaking at your normal voice level, adjust [VOX DELAY] as desired.
- ⑥ Select "ANTI-VOX" in the Quick Set mode.
 - Push [UP ▲]/[▼ DN] one or more times to select "ANTI-VOX."
- ⑦ If the received audio from the speaker toggles the transceiver to transmit, adjust the "ANTI-VOX" to the point where it has no effect.
- ⑧ Push [SET] to exit the the Quick Set mode.

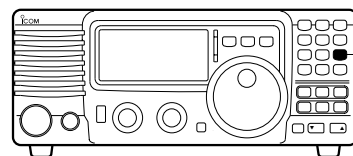

[VOX] switch

◇ Optional AT-180 AUTOMATIC ANTENNA TUNER operation

The AT-180 automatic antenna tuner automatically matches the IC-718 to the antenna. Once the tuner matches the antenna, the tuning settings are memorized as a preset point for each frequency range (100 kHz steps). Therefore, when you change the frequency range, the tuning circuits are automatically set to the memorized point.

CAUTION: NEVER transmit with the tuner ON when no antenna is connected. This will damage both the transceiver and the antenna tuner.

DO NOT! connect the AT-180 and AH-4 or AH-740 at the same time. Both tuners will not be function correctly.

TUNER OPERATION

• Tuner type setting (p. 46)

- ① Hold down [PWR] for 1 second to turn power OFF.
- ② While pushing and holding [SET], push [PWR] to turn power ON.
- ③ Push [UP ▲] or [▼ DN] one or more times to select [TUNER].
- ④ Rotate the main dial to select "18."
 - AT-180 AUTOMATIC ANTENNA TUNER is selected.

NOTE: NEVER select "4" (AH-4 AUTOMATIC ANTENNA TUNER), otherwise the transceiver automatically transmits when you turn ON the power. Push [TUNER] to cancel the unexpected transmission. Then, reselect the correct tuner type.

- ⑥ Hold down [PWR] for 1 second to turn power OFF.
- ⑦ Push [PWR] to turn power ON again.

• AUTO TUNE:

Push [TUNER] to turn the tuner ON. The antenna is tuned automatically during transmission when the antenna SWR is higher than 1.5:1.

- When the tuner is OFF, "[TUNE]" goes out.

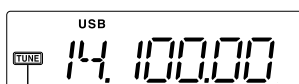
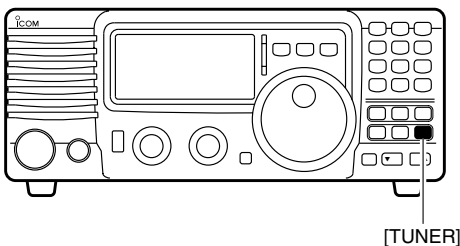

Tuning indicator;

• MANUAL TUNING

During SSB operation at low voice levels, the AT-180 may not tune correctly. In such cases, manual tuning is helpful.

Hold down [TUNER] for 1 second to start manual tuning.

- CW mode is selected, a side tone is emitted, and "[TUNE]" blinks; then, the previous mode is selected.

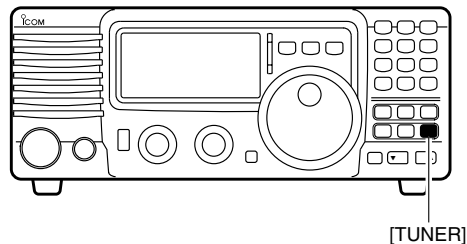

Hold down 1 second to start manual tuning.

If the tuner cannot reduce the SWR to less than 1.5:1 after 20 seconds of tuning, "[TUNE]" goes out. In this case, check:

- the antenna connection and feedline
- the antenna SWR (p. 27: Meter function)

• Through inhibit

The AT-180 has a through inhibit mode. When selecting this mode, you can use the tuner at poor SWR's. In this case, automatic tuning in the HF bands activates only when exceeding an SWR of 3:1. Therefore, manual tuning is necessary each time you change the frequency. Although termed "through inhibit," the signal will pass "through" the tuner if the SWR is higher than 3:1 after tuning.

CONVENIENT

• Tuner sensitive condition

If you require critical tuning at any time during transmission, select the tuner sensitive condition. See page 51 for selection.

• Automatic tuner start

If you want to turn OFF the tuner when the VSWR is 1.5:1 or less, use "automatic tuner on" and turn the tuner OFF. See page 46 for turning the function ON or OFF.

◇ Optional external tuner operation

⚠ DANGER! HIGH VOLTAGE!
NEVER touch the antenna element while tuning or transmitting. Always place it in a secure place.

NEVER operate the AH-4 or AH-740 without an antenna connected. The tuner and transceiver will be damaged.

NEVER operate the AH-4 or AH-740 if it is not grounded.

Transmitting before tuning may damage the transceiver. Note that the AH-4 cannot tune when using a $1/2 \lambda$ long wire or multiple of the operating frequency.

AH-4

The AH-4 matches the IC-718 to a long wire antenna more than 7 m/23 ft long (3.5 MHz and above).

- See page 14 for connection details.
- See the AH-4 instruction manual for AH-4 installation and connection details.

AH-740

The optional AH-740 covers 2.5 to 30 MHz range with a supplied whip antenna element. Or when using with the optional NVIS kit, it covers 2.2 to 30 MHz range.

- See page 14 for connection details.
- See the AH-740 instruction manual for the installation and connection details.

TUNER OPERATION

Tuning is required for each frequency. **BE SURE** to retune the antenna before transmitting when you change the frequency, even slightly.

• Tuner type setting (p. 46)

- ① Hold down [PWR] for 1 second to turn power OFF.
- ② While pushing and holding [SET], push [PWR] to turn ON the power.
- ③ Push [UP ▲] or [▼ DN] one or more times to select [TUNER].
- ④ Rotate the main dial to select “4.”
 - AH-4 AUTOMATIC ANTENNA TUNER is selected.
 - Also select “4” when using the optional AH-740.
- ⑤ Hold down [PWR] for 1 second to turn power OFF.
- ⑥ Push [PWR] to turn ON the power.

• MANUAL TUNING

- ① Set the desired frequency in an HF band.
 - The IC-718 will not transmit outside of the ham bands.
- ② Hold down [TUNER] for 1 second.
 - “[TUNE]” blinks and “CW” appears while tuning.

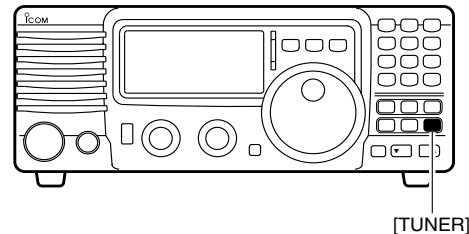

- ③ “[TUNE]” lights constantly when tuning is complete.
 - When the connected wire cannot be tuned, “[TUNE]” goes out, the AH-4 or AH-740 is bypassed and the antenna wire is directly connected to the antenna connector on the transceiver.
- ④ To manually bypass the AH-4 or AH-740, push [TUNER] to turn it OFF.

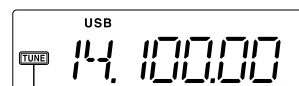

Tuning indicator;
 Blinks: Tuning now
 Appears: Tune is completed
 Disappears: Tune cannot be completed

CONVENIENT

• PTT tune function

The AH-4 or AH-740 is always tuned when the PTT is pushed after the frequency is changed more than 1%. This function removes the “hold down [TUNER]” operation and activates first transmission on the new frequency. This function is turned ON in initial set mode (p. 46).

■ Function for CW

◇ Connection for CW

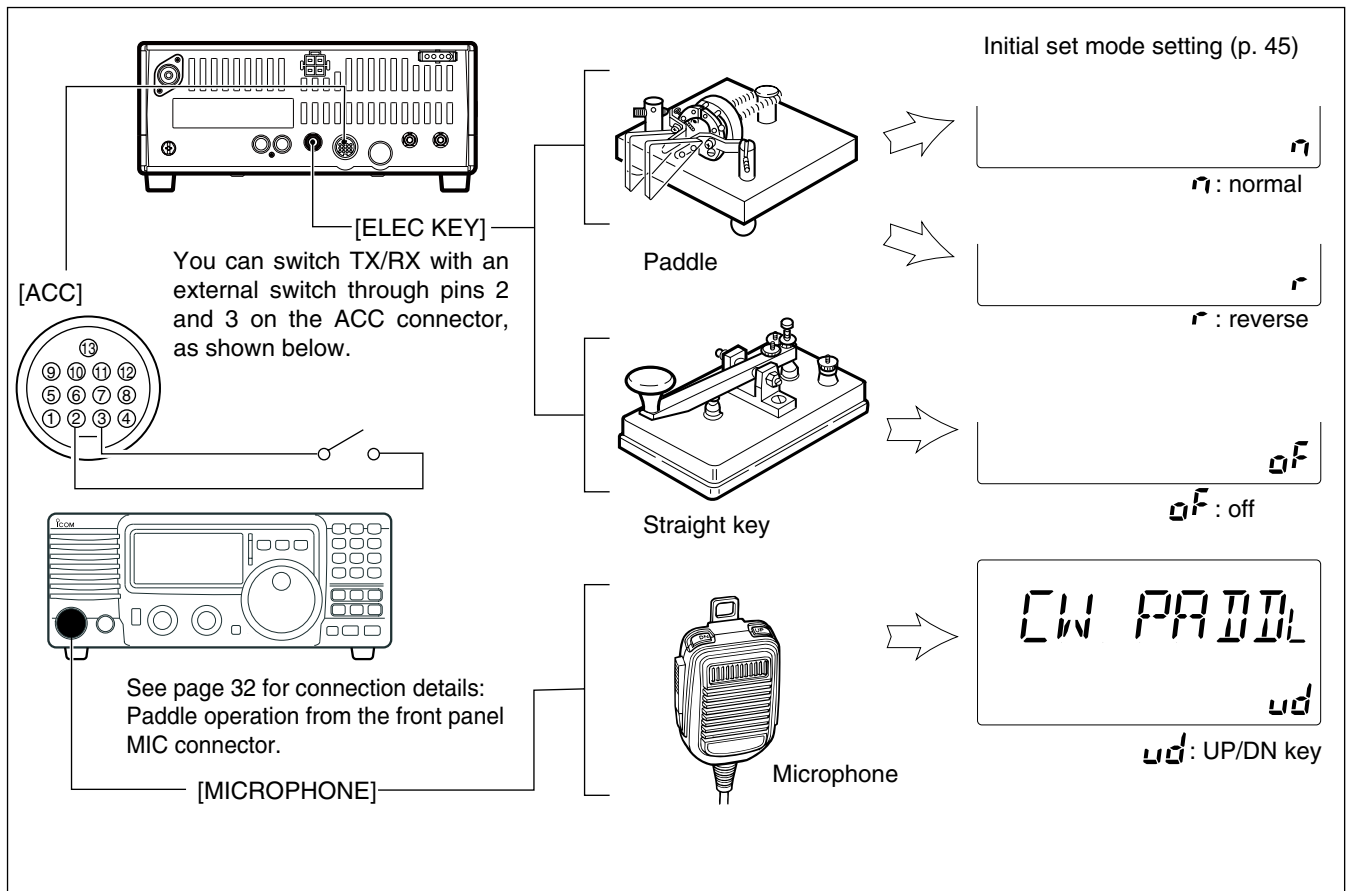

◇ CW operation

- ① Connect a paddle or straight key as shown above.
- ② Select CW (or CW-REV) mode by pushing [MODE].
- ③ Set the CW break-in operation to semi break-in, full break-in or OFF. (p. 42)
 - Hold down [SET] for 1 second to enter the Quick Set mode.
 - Push [UP ▲]/[▼ DN] one or more times until "BK-IN" appears, then rotate the main dial to select the desired operation:
 - FL: full break-in
 - SE: semi break-in
 - oF: no break-in
- ④ Set the CW delay time when semi break-in operation is selected. (p. 43)
 - Hold down [SET] for 1 second to enter the Quick Set mode. Push [UP ▲]/[▼ DN] one or more times until "BK-DELAY" appears, then rotate the main dial to set the desired delay time.

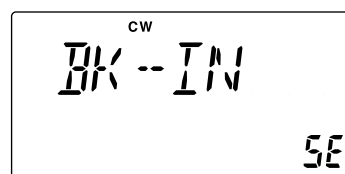

CW mode and semi break-in operation are selected.

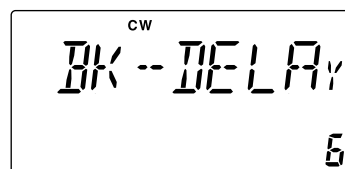

Delay time of 6 dots is selected in the Quick set mode for semi break-in operation.

5 RECEIVE AND TRANSMIT

◇ CW pitch control

The received CW tone pitch and monitored CW tone pitch can be adjusted to suit your preferences (300 to 900 Hz) without changing your transmitting frequency.

- ① Hold down [SET] for 1 second to enter the Quick Set mode.
- ② Push [UP ▲]/[▼ DN] one or more times until “CW PITCH” appears, then rotate the main dial to set the desired pitch.

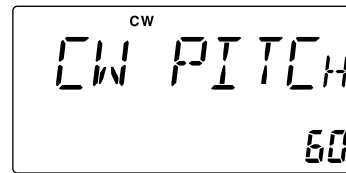

This shows the default setting for the CW pitch control (600 Hz).

◇ CW reverse mode

The CW-R (CW Reverse) mode receives CW signals with the reverse side CW carrier point like that of the LSB and USB modes. Use this mode when interfering signals are near the desired signal and you want to change the interference tone.

- ① Push [MODE] one or more times to select the CW mode.
- ② Hold down [MODE] for 1 second to toggle between the CW and CW-R modes.

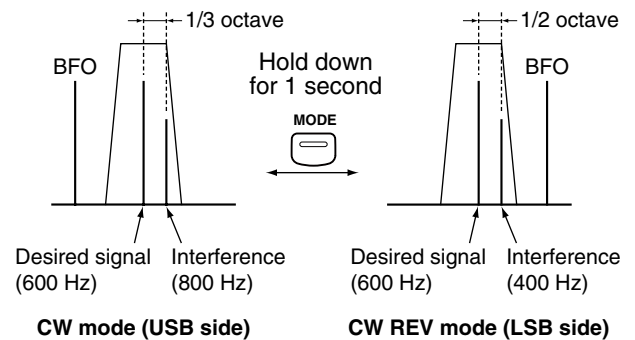

◇ Electronic CW keyer

The IC-718 has an electronic keyer installed. Both keying speed and weight (the ratio of dot : space : dash) can be set in the Quick Set mode.

• Setting the electronic keyer

- ① Push [MODE] one or more times to select the CW mode.
- ② While pushing and holding [SET], push [POWER] to enter initial set mode.
- ③ Push [UP ▲]/[▼ DN] one or more times until “CW PADDL” appears, then rotate the main dial to select the paddle type.
 - When “ud” is selected, the up/down switches on the microphone can be use as a paddle.
 - When using the up/down switches as a paddle, squeeze keying cannot be done.
- ④ Push [UP ▲]/[▼ DN] one or more times until “KEY RAT” appears, then rotate the main dial to select the desired weight to between 2.8 and 4.5.
- ⑤ Push [UP ▲]/[▼ DN] one or more times until “KEY SPD” appears, then rotate the main dial to select the desired weight to between 6 and 60.

Paddle operation from front panel MIC connector
Connect a CW paddle to operate the built-in electronic keyer from the front panel MIC connector.

KEYING WEIGHT EXAMPLE: morse code “K”

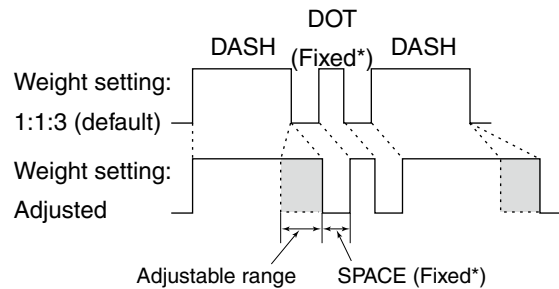

*SPACE and DOT lengths can be adjusted with “KEY SPC” in the the Quick Set mode only.

Paddle operation

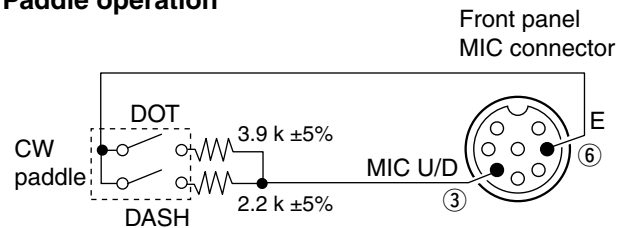

- This function is usable from only the front panel mic connector.
- Select item “n,” “r,” or “oF” in CW PADDL in initial set mode.
- Connect straight key to “DOT” side.

■ Function for RTTY

◇ Connection for RTTY (FSK)

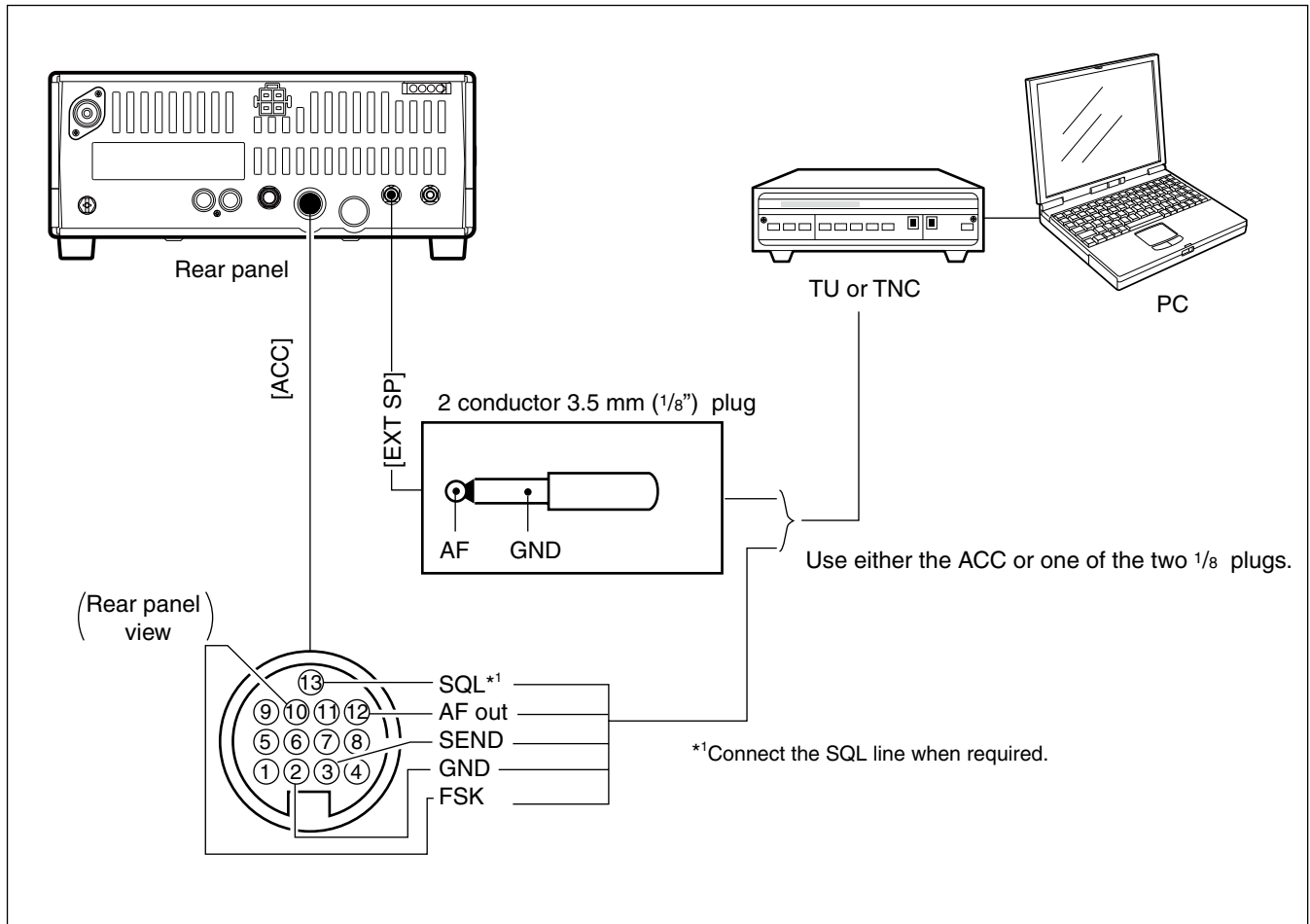

◇ Connection for AFSK

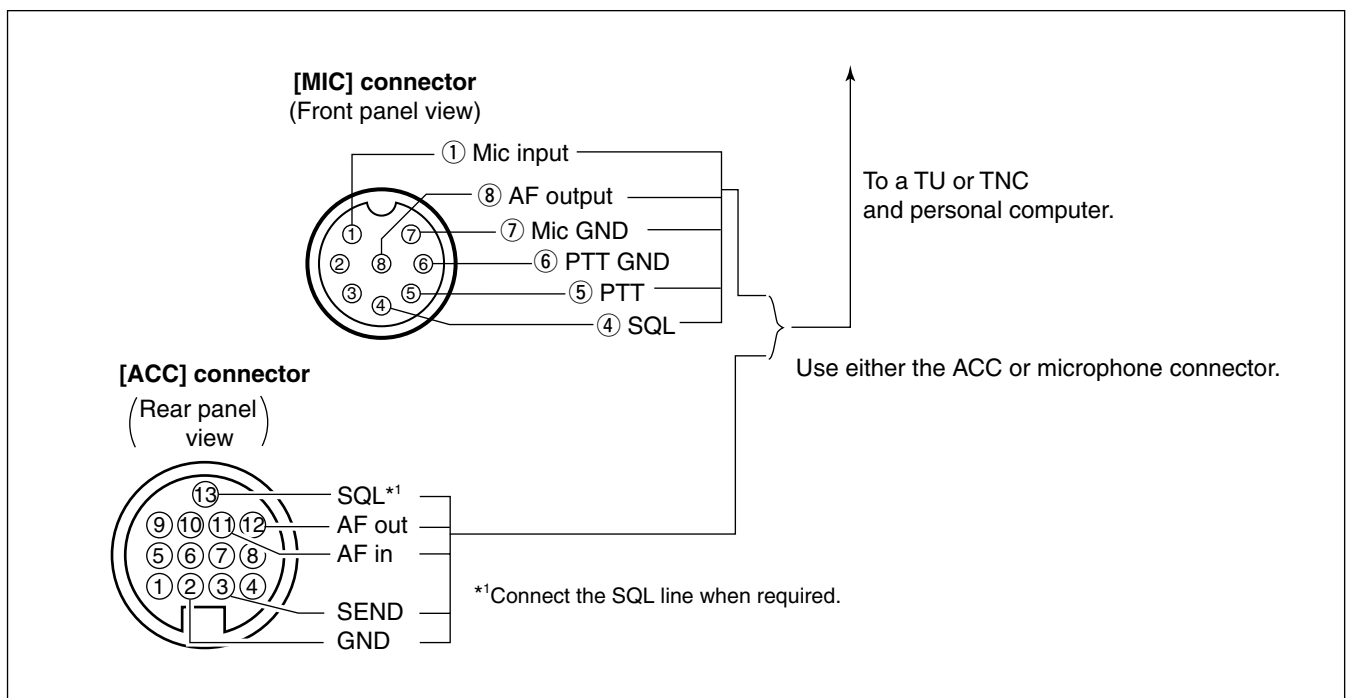

5 RECEIVE AND TRANSMIT

◇ RTTY (FSK) operation

- ① Connect a terminal unit as described on page 34.
- ② Select the RTTY (or RTTY-R) mode by pushing [MODE].
- ③ Select the desired mark and shift frequencies as described below.
- ④ Set the desired operating frequency with the main dial.
- ⑤ Start using the PC or TNC (TU).



RTTY mode is selected.

PRESETTING FOR RTTY

• Tone frequency

- ① Hold down [SET] for 1 second to enter the Quick Set mode.
- ② Push [UP ▲]/[▼ DN] one or more times until "TON 2125" appears, then rotate the main dial to select the desired tone frequency.

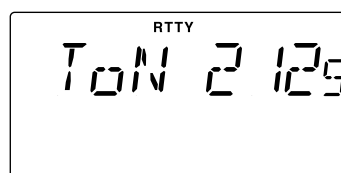

RTTY mark frequency is set to 2125 Hz. 2125, 1615 and 1275 Hz can be used.

• Shift frequency

- ① Hold down [SET] for 1 second to enter the Quick Set mode.
- ② Push [UP ▲]/[▼ DN] one or more times until "SIFT 170" appears, then rotate the main dial to select the desired shift frequency.



RTTY shift frequency is set to 850 Hz. 850, 425, 200 and 170 Hz can be used.

• RTTY reverse mode

Received characters are occasionally garbled when the receive signal is reversed between MARK and SPACE. This reversal can be caused by incorrect TNC connections, settings, commands and so on.

To receive a reversed RTTY signal correctly, select the RTTY-R (RTTY reverse) mode.

- Hold down [MODE] for 1 second to select the RTTY-R (RTTY reverse) mode.

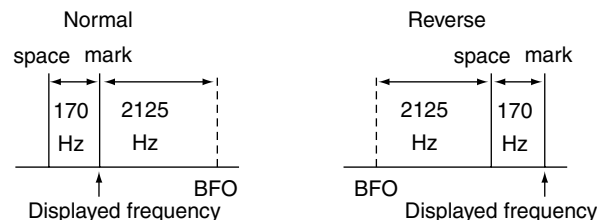

◇ RTTY (AFSK) operation

- ① Connect a terminal unit as described on page 33.
- ② Select the SSB (LSB) mode by pushing [MODE].
 - Generally, LSB is used on the HF bands.
- ③ Select the desired FSK tone/shift frequencies and keying polarity the same way as for the FSK operation.
- ④ Set the desired frequency with the main dial.
- ⑤ Start using the PC or TNC (TU).

Memory channels

The transceiver has 101 Memory channels. The Memory mode is very useful for quickly changing to often-used frequencies.

All 101 Memory channels are tunable, which means the entered frequency can be tuned temporarily with [DIAL] in the Memory mode.

MEMORY CHANNEL	MEMORY CHANNEL NUMBER	CAPABILITY	TRANSFER TO VFO	OVER-WRITING	CLEAR
Regular memory channels	1-99	One frequency and one mode in each memory channel.	Yes	Yes	Yes
Scan edge memory channels	P1, P2	One frequency and one mode in each memory channel as scan edges for a programmed scan.	Yes	Yes	No

Memory channel selection

Using the [UP ▲] or [▼ DN] keys

- Push [V/M] to select the Memory mode.
 - “MEMO” appears.
- Push [CH] to enter the memory CH select mode.
 - “MEMO” blinks.
- Push [UP ▲] or [▼ DN] several times to select the desired Memory channel.
 - Hold down [UP ▲] or [▼ DN] to scroll to the desired memory.
- Push [CH] to exit the memory CH select mode.
- To return to the VFO mode, push [V/M] again.

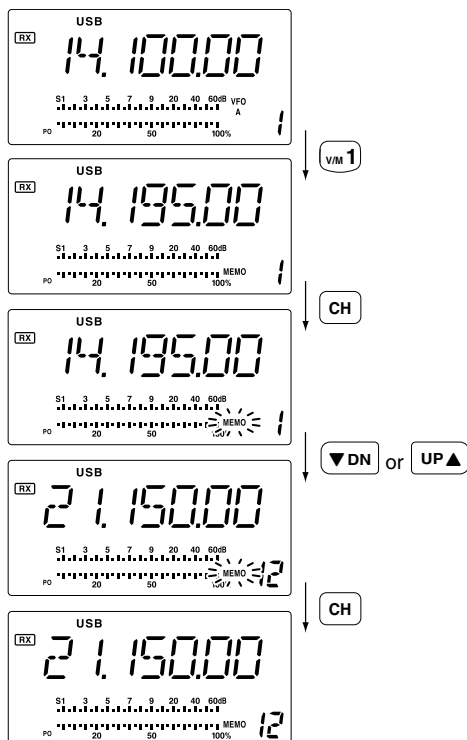

Using the keypad

- Push [V/M] to select the Memory mode.
 - “MEMO” appears.
- Push [CH] to enter the memory CH select mode.
 - “MEMO” blinks.
- Push [F-INP/ENT], then push the desired Memory channel number using the keypad.
- Push [F-INP/ENT] to select the desired Memory channel.
- Push [CH] to exit the memory CH select mode.

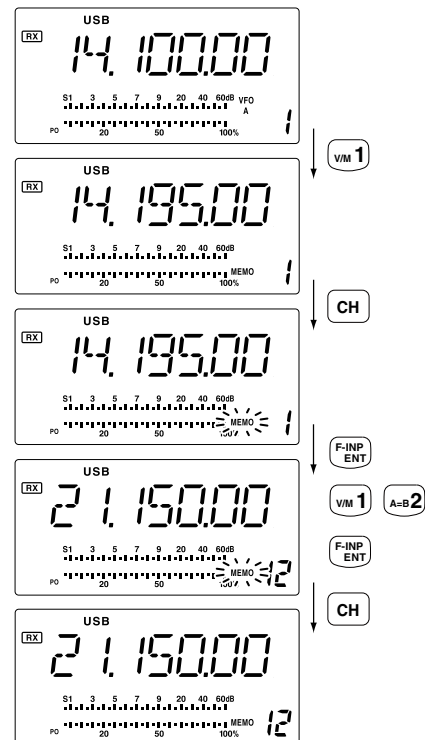

Memory channel entry

Memory channel entry can be performed either in the VFO mode or in the Memory mode.

◇ Entering data in the VFO mode

- ① Set a desired frequency and operating mode in the VFO mode.
- ② Push [CH], then push [UP ▲] or [▼ DN] several times to select the desired Memory channel.
 - “MEMO” blinks.
 - “BLANK” appears if the selected Memory channel is a blank channel.
- ③ Hold down [MW] for 1 second to program the displayed frequency and operating mode into the Memory channel.
- ④ Push [CH] to exit Memory channel select mode.

[EXAMPLE]: Entering 7.086 MHz/LSB into Memory channel 10.

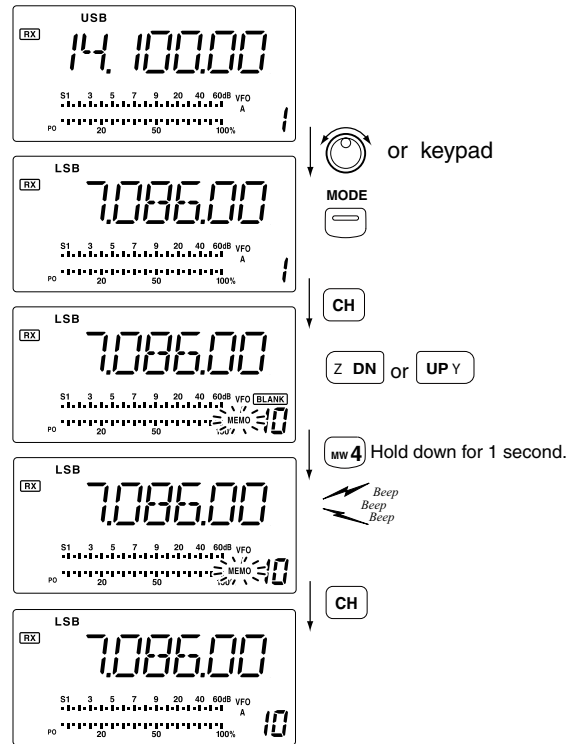

◇ Entering data in the Memory mode

- ① Select the desired Memory channel by pushing [UP ▲] or [▼ DN] in the Memory mode.
 - “BLANK” appears if the selected Memory channel is a blank channel (has no contents).
- ② Enter the desired frequency and operating mode in the Memory mode.
 - In a blank channel, first directly enter the frequency using the keypad.
- ③ Hold down [MW] for 1 second to enter the displayed frequency and operating mode into the Memory channel.
 - Preamp setting, attenuator ON and OFF, and AGC settings can also be entered into a Memory channel.

[EXAMPLE]: Entering 21.280 MHz/CW into Memory channel 18.

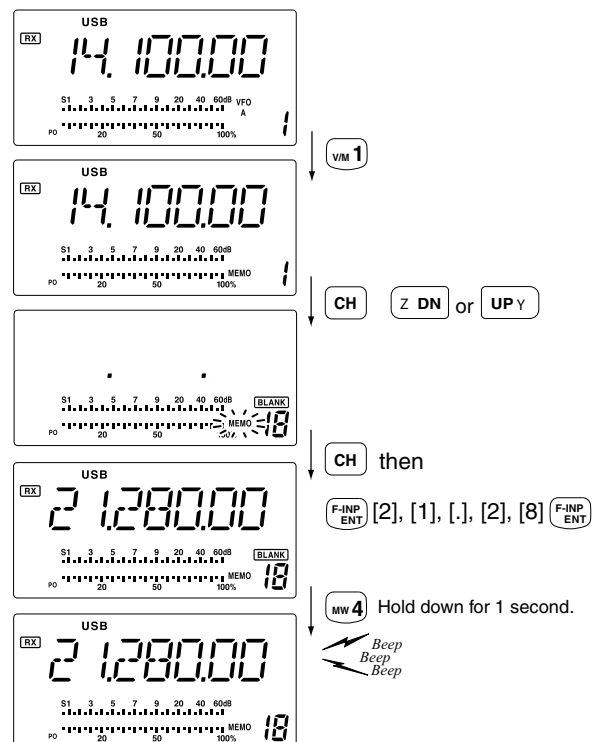

■ Transferring data to the VFO

The frequency and operating mode in a Memory channel can be transferred to the VFO.

Transferring data can be performed in either the VFO or Memory mode.

◇ Transferring in VFO mode

This is useful for transferring entered contents to the VFO.

- ① Select the VFO mode by pushing [V/M].
- ② Push [CH], then select the Memory channel to be transferred by pushing [UP ▲] or [▼ DN].
 - “BLANK” appears if the selected Memory channel is a blank channel.
- ③ Hold down [M▶V] for 1 second to transfer the frequency and operating mode.
 - The transferred frequency and operating mode are displayed on the function display.
- ④ Push [CH] to exit the Memory channel select mode.

TRANSFERRING EXAMPLE IN THE VFO MODE

Operating frequency: 21.320 MHz/USB (VFO)

Contents of M-ch 12: 14.180 MHz/CW

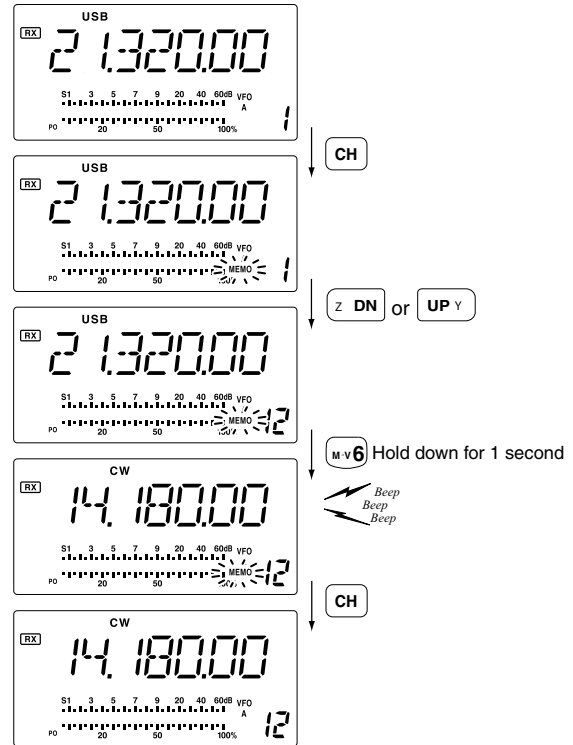

6 MEMORY OPERATION

◇ Transferring in the Memory mode

This is useful for transferring frequency and operating mode while operating in the Memory mode.

When you have changed the frequency or operating mode in the selected Memory channel:

- The **displayed** frequency and mode are transferred to the VFO.
- The **entered** frequency and mode in the Memory channel are not transferred to the VFO, and they remain in the Memory channel.

- ① Push [CH], then select the Memory channel to be transferred by pushing [UP ▲] or [▼ DN] in the Memory mode.
 - Enter the frequency or operating mode if required.
- ② Hold down [M▶V] for 1 second to transfer the frequency and operating mode.
 - The displayed frequency and operating mode are transferred to the VFO.
- ③ To return to the VFO mode, push [V/M] momentarily.

TRANSFERRING EXAMPLE IN MEMORY MODE

Operating frequency: 14.020 MHz/CW (M-ch 16)

Contents of M-ch 16: 14.018 MHz/CW

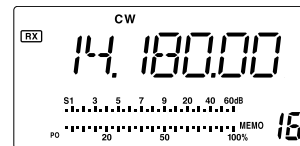

Rotate dial.

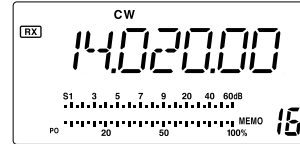

[M▶V] 6 Hold down for 1 second.

Beep
Beep
Beep

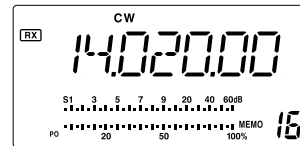

[V/M] 1

VFO A is displayed.

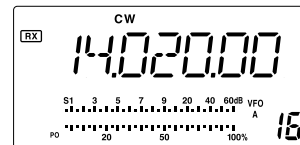

[V/M] 1

M-ch 16 is displayed.

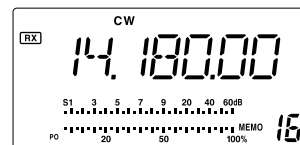

■ Memory clearing

Any unnecessary Memory channels can be cleared. The cleared Memory channels become blank channels.

- ① Select the Memory mode by pushing [V/M].
- ② Push [CH], then select the Memory channel to be cleared by pushing [UP ▲] or [▼ DN].
- ③ Hold down [M-CL] for 1 second to clear the contents.
 - The entered frequency and the operating mode disappear.
 - "BLANK" appears.
- ④ To clear other Memory channels, repeat steps ② and ③.

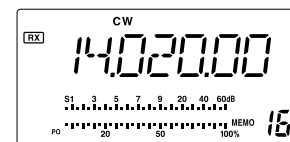

[M-CL] 5 Hold down for 1 second.

Beep
Beep
Beep

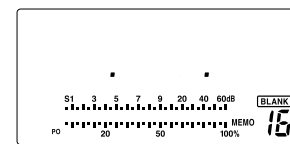

■ Scan types

PROGRAMMED SCAN

Repeatedly scans between two scan edge frequencies (scan edge memory channels P1 and P2).

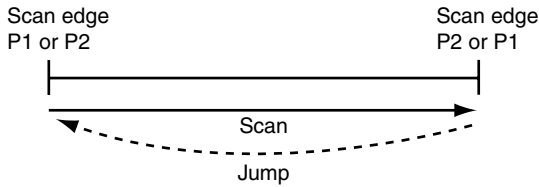

This scan operates in VFO mode.

MEMORY SCAN

Repeatedly scans all programmed memory channels.

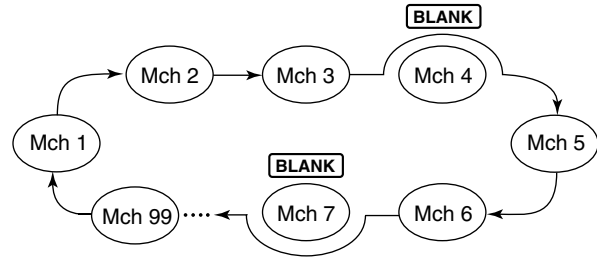

This scan operates in the memory mode.

■ Preparation

• Channels

For programmed scan/auto memory write scan:

Enter scan edge frequencies into scan edge Memory channels P1 and P2.

For a memory scan:-

Enter 2 or more Memory channels except scan edge Memory channels.

• Scan resume ON/OFF

You can select the scan to resume or cancel when detecting a signal, in the Set mode. Scan resume ON/OFF must be set before operating a scan. See page 45 for ON/OFF setting and scan resume condition details.

• Scan speed

Scan speed can be selected from 2 levels, high or low, in the Initial Set mode. See page 45 for details.

• Squelch condition

Scan start with	Programmed scan	Memory scan
Squelch open	The scan continues until it is stopped manually, and does not pause even if it detects signals.	Scan pauses on each channel when the scan resume is ON, not applicable when OFF.
Squelch open closed	Scan stops when detecting a signal. If you set scan resume ON in the Initial Set mode, the scan paused for 10 seconds when detecting a signal, then resumes. When a signal disappears while scan is paused, scan resumes 2 seconds later.	

■ Programmed scan operation

- ① Select the VFO mode by pushing [V/M].
- ② Select the desired operating mode.
 - The operating mode can also be changed while scanning.
- ③ Set [RF/SQL] open or closed.
 - See the previous page for scan details.
 - If the [RF/SQL] control function is set as RF control, the squelch always opens. See pages 15, 20 for details.
- ④ Push [SCAN] to start the programmed scan.
 - “SCAN” appears while scanning.
- ⑤ When the scan detects a signal, the scan stops, pauses or ignores it, depending on the resume setting and the squelch status.
- ⑥ To cancel the scan, push [SCAN].

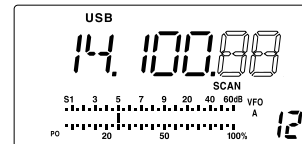

/// If the same frequencies are programmed into the P1 and P2 scan edges Memory channels, the scan does not start.

■ Memory scan operation

- ① Select Memory mode by pushing [V/M].
- ② Select the desired operating mode.
 - The operating mode can also be changed while scanning.
- ③ Set [RF/SQL] open or closed.
 - See previous page for scan details.
 - If the [RF/SQL] control function is set as an RF control, the squelch is always opened. See pages 14, 30 for details.
- ④ Push [SCAN] to start the memory scan.
 - “SCAN” appears while scanning.
- ⑤ When the scan detects a signal, the scan stops, pauses or ignores it, depending on the resume setting and the squelch status.
- ⑥ To cancel the scan, push [SCAN].



/// 2 or more Memory channels must have entered content for memory scan to start.

■ General

The Set mode is used for programming infrequently changed values or conditions of functions. The IC-718 has 2 separate set modes: *Quick Set mode* and *Initial Set mode*.

◇ Quick Set mode operation

- ① While power is ON, hold down [SET] for 1 second.
 - The Quick Set mode is selected and one of its items appears.
- ② Push [UP ▲] or [▼ DN] to select the desired item.
- ③ Rotate the main dial to set the values or options for the selected item.
- ④ Repeat ② and ③ to set other items.
- ⑤ To exit the Quick Set mode, momentarily push [SET].

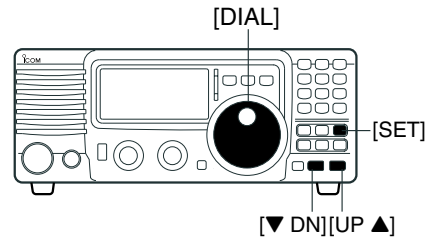

[DISPLAY EXAMPLE: QUICK SET MODE]

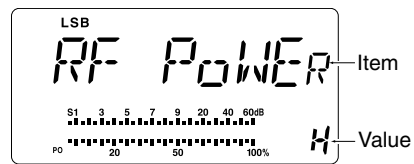

◇ Initial Set mode operation

- ① Hold down [POWER] for 1 second to turn power OFF.
- ② While holding down [SET], push [POWER] to turn the power ON.
 - The Initial Set mode is selected and one of its items appears.
- ③ Push [UP ▲] or [▼ DN] to select the desired item.
- ④ Rotate the main dial to set the values or options for the selected item.
- ⑤ Repeat ③ and ④ to set other items.
- ⑥ To exit the Initial Set mode, hold down [PWR] for 1 second to turn the power OFF.
- ⑦ Push [PWR] to turn power ON again.
 - The settings you made in the Initial Set mode are now effective.

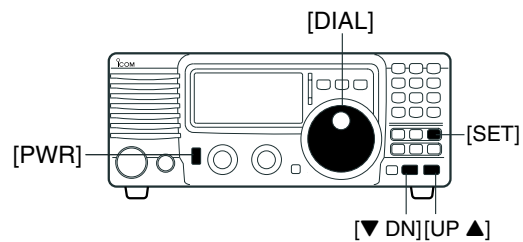

[DISPLAY EXAMPLE: INITIAL SET MODE]

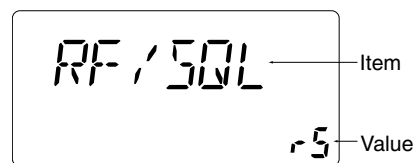

■ Quick Set mode items

• RF power

This item adjusts the RF output power. The RF output power can be adjusted from L, 1 to 99 and H.

•The default is H (maximum power).

Note that while adjusting the output power, the power meter is automatically displayed.

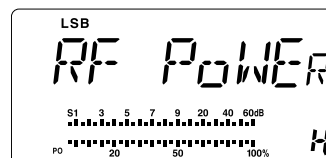

• Mic gain

This item adjusts microphone gain from 0 to 99 and H. The default is 50.

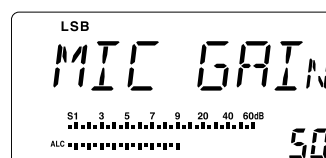

• VOX gain

This item adjusts the VOX gain for the VOX (voice activated transmit) function.

The default is 50.

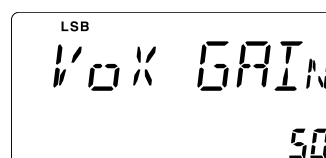

• VOX delay

This item adjusts the VOX (voice activated transmit) delay time from 0 to 2 seconds in 0.1 second units.

The default is 10 (1.0 second).

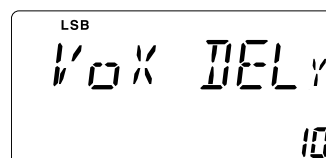

• Anti VOX level

This item adjusts the ANTI-VOX gain for the VOX (voice activated transmit) operation.

The default is 50.

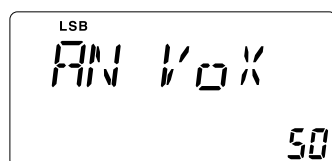

• CW pitch

This item adjusts CW tone pitch from 300 Hz to 900 Hz in 10 Hz steps.

The default is 60 for 600 Hz.

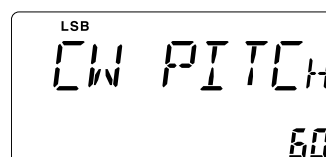

• BK-IN

This item selects break-in type for CW operation from the following values:

oF: No break-in is enabled (default).

SE: Semi break-in is enabled.

FL: Full break-in is enabled.

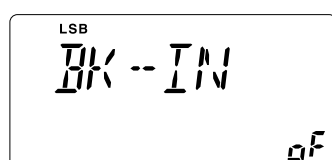

• BK-IN delay

This item adjusts break-in delay time for CW semi break-in operation from 2.0 to 13 (dots).
The default is 7.

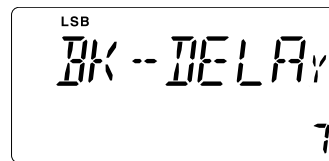

• Key speed

This item adjusts the CW keying speed from 6 to 60* wpm.
The default is 20 wpm.

* Some speeds between 6 and 60 cannot be selected.

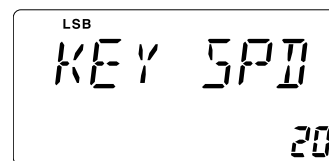

• Key ratio

This item selects the CW key ratio (or weight) from 2.8 to 4.5.

The default is 30 (3.0).

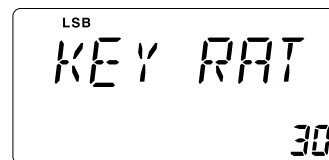

• RTTY mark tone

This item selects the Mark. You can select 1275, 1615 and 2125 Hz.

The default is 2125 Hz.

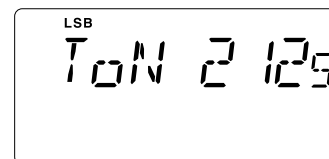

• RTTY shift

This item selects RTTY shift from 170, 200, 425 and 850.
The default is 170 Hz.

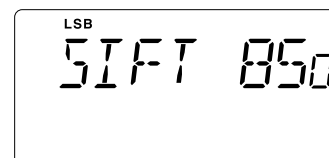

• Dimmer

This item selects the LCD back light brightness from Off, Low and High.

The default is "HI" (High).

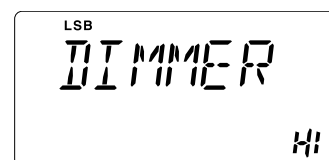

■ Initial Set mode items

• Mode select

This item allows you to simplify operation by inhibiting any unneeded operating modes. For example if you only use the LSB and USB modes, use “MODE SELECTION” to inhibit access to all other modes (CW, RTTY and AM), therefore selecting LSB and USB is quick and easy.

The default is ON for all operating modes. To toggle an operating mode ON or OFF, push [MODE] one or more times until the desired mode is displayed. Then rotate the main dial to set to ON or OFF.



• RF/SQL VR

The [RF/SQL] control can be set as:

- RF/squelch control
- Automatic
(acts as squelch in AM modes, as RF in SSB/CW/RTTY modes)
- Squelch control (p. 20)

The default is “rS” (RF/squelch).

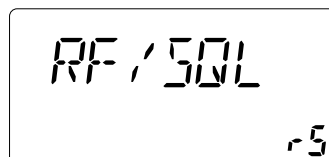

• Beep

A beep sounds each time a key is pushed to confirm it. This function can be turned OFF for silent operation. The default is “on” (ON).

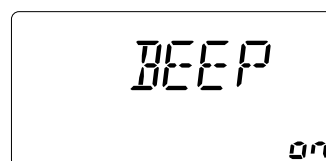

• Beep level

This item adjusts the confirmation beep level. The default is 50.

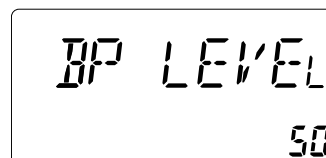

• Band edge beep

A beep sounds when an operating frequency enters or exits a transmit frequency range. This functions independent of the confirmation beep setting. The default is “on” (ON).

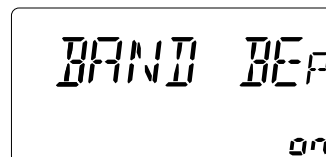

• Side-tone level

This item adjusts the CW side-tone level. The default is 30.

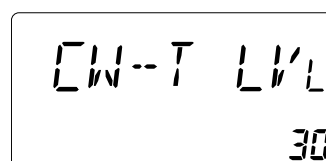

• Meter peak hold

This item selects meter peak hold function ON or OFF.
The default is “on” (ON).

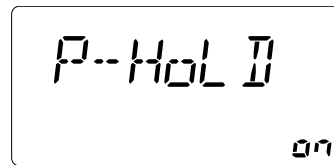

• Scan speed

This item sets the speed at which channels or frequencies are scanned during scan operations. High or Low can be selected.

The default is “HI” (High).

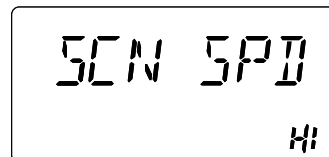

• Scan resume

This item sets the scan resume function ON or OFF.

ON: Scan resumes 10 seconds after stopping on a signal or 2 seconds after a signal disappears.

OFF: Scan does not resume after stopping on a signal. For the priority watch, setting to OFF pauses the watch until the signal disappears and the scan resumes.

The default is “on” (ON).

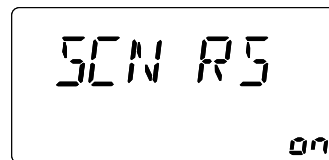

• AM Noise blanker

This item is used in the AM mode to blank unwanted noise, such as ignition noise.

The default is “on” (ON).

NOTE: The noise blanker function may degrade the audio if use when listening to regular AM radio broadcasts.

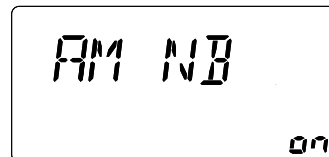

• Auto TS

This item sets auto tuning speed. The tuning dial normally changes the frequency 1.5 kHz/revolution in 10 Hz tuning step. When auto tuning step is turned ON this increases to 30 kHz/revolution in 50 Hz tuning step during quick rotation of the dial.

The default is “on” (ON).

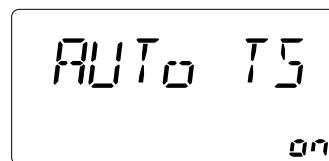

• Key type

This item adjusts the CW paddle type. Select from the following options.

- n: normal (for electronic keyer use)
- r: reverse (for electronic keyer use)
- oF: Turns OFF the electronic keyer (for straight key use)
- ud: For using the microphone's [UP]/[DN] keys instead of the paddle.

The default is “n” (normal).

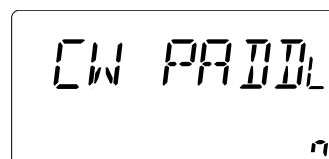

8 SET MODE

• Tuner type

This item selects optional antenna tuner type. Select from the following options.

- no: No optional tuner connected.
 - 4: The optional AH-4 antenna tuner.
(Select this type also when using the optional AH-740.)
 - 18: The optional AT-180 antenna tuner.
- The default is “no.”

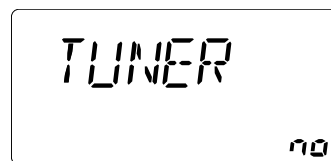

• Auto tune

The optional AT-180 ANTENNA TUNER has an automatic start capability which starts tuning if the SWR is higher than 1.5–3.

When “OFF” is selected, the tuner remains off, even when the SWR is poor (1.5–3). When “ON” is selected, the automatic tune starts even when the tuner is turned OFF.
The default is “oF” (OFF).

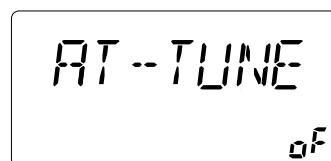

• PTT tune

The optional AH-4, AH-740 or AT-180 AUTOMATIC ANTENNA TUNER can automatically start tuning the moment the PTT is pushed.

The default is “oF” (OFF).

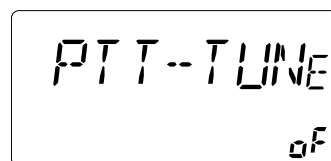

• Speech language*

The optional UT-102 VOICE SYNTHESIZER UNIT allows you to select between English and Japanese as the speech language.

The default is “En” (English).

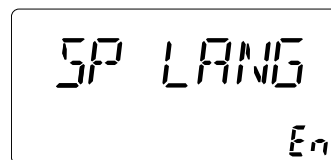

• Speech speed*

The optional UT-102 VOICE SYNTHESIZER UNIT allows you to select faster or slower synthesizer output.

The default is “HI” (High).

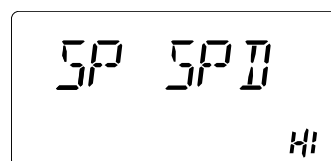

• Speech S-meter level*

The optional UT-102 allows you to set the synthesizer to read the frequency/mode only (OFF), or both the frequency/mode and S-meter level (ON).

The default is “on” (ON).

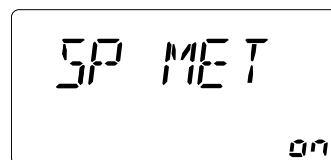

• CI-V baud rate

This item sets the data transfer rate. When “Auto” is selected, the baud rate is automatically set according to the connected controller or remote controller.

The default is “At” (Auto).

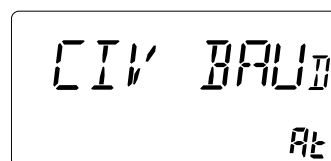

* The UT-102 VOICE SYNTHESIZER is no longer produced and these setting items do not function.

• CI-V address

To distinguish it from other equipment, each CI-V capable transceiver has its own Icom standard address in hexadecimal code. The IC-718's address is 5E.

When 2 or more IC-718s are connected to an optional CT-17 CI-V LEVEL CONVERTER, rotate the main dial to select a different address between 01H to 7FH, for each IC-718.

The default is 5E.

CIV ADD
5E

• CI-V Transceive

Transceive operation is possible with the IC-718 connected to other Icom HF transceivers or receivers. When "on" is selected, changing the frequency, operating mode and so on, on the IC-718 automatically changes those of connected transceivers (or receivers) and vice versa.

The default is "on" (ON).

CIV TRN
on

• CI-V 731 mode

When connecting the IC-718 to the IC-735 for transceive operation, you must change the operating frequency data to 4 bytes.

- This item MUST be set to "on" when operating the IC-718 with the IC-735.

The default is "oF" (OFF).

CIV 731
oF

• Optional filter

When an optional IF filter is installed, you must first set the item to "on" to be able to select the filter. Selectable filters are FL-96†, FL-222, FL-52A†, FL-53A†, FL-257 and none (default). See page 24 for usable filters for each mode and see page 50 for filter installation.

FIL no

• Expanded filter selection

When an optional IF filter is installed, this selection expands filter and filter selection (W/N) key combination on operating mode independent.

EXP FIL
oF

• Filter selection (Wide/Narrow)

When an optional IF filter is installed, you can arrange the filter and filter selection key combination. (p. 25)

^{CW}
WIDE THU

^{AM}
NARW NOR

†This filter is no longer produced.

■ Opening the transceiver's case

Follow the case and cover opening procedures shown here when you want to install an optional unit or adjust an internal unit, and so on.

CAUTION: DISCONNECT the DC power cable from the IC-718 before performing any work on the transceiver. Otherwise, there is danger of electric shock and/or equipment damage.

- ① Remove the 5 screws from the top of the transceiver and 4 screws from the sides, then lift up the top cover.
- ② Remove the 5 screws from the bottom of the transceiver, then remove the bottom cover.

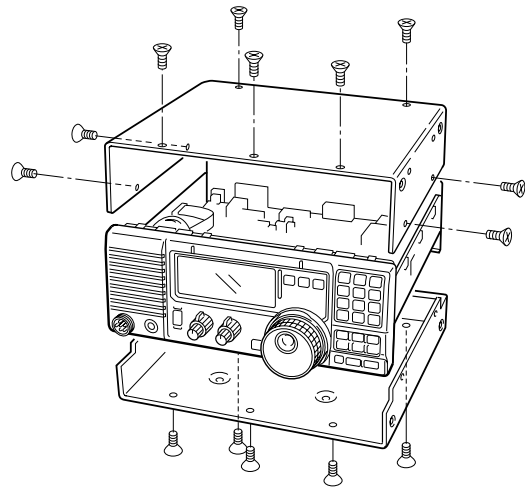

◇ Carrying handle

Installation

An optional handle allows you to easily carry and transport the transceiver.

Attach the MB-23 CARRYING HANDLE with the supplied rubber feet as shown to the right.

NOTE: Use only the supplied screws to attach the handle. Otherwise, the handle may not be attached correctly and may drop the transceiver.

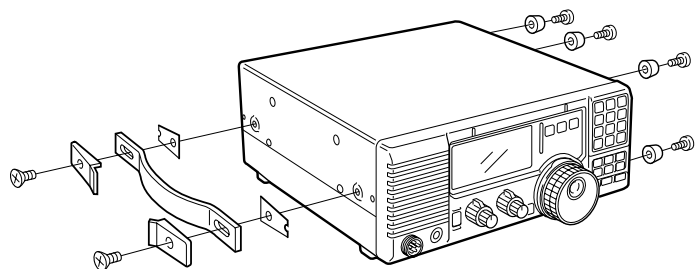

■ Installing the MB-118 MOBILE MOUNTING BRACKET

◇ Mounting bracket

The universal mounting bracket allows overhead mounting.

Installation

Securely mount the transceiver with the 4 supplied screws (5 x 20) to a thick surface which can support more than 3.80 kg (8.38 lb).

CAUTION: Non-supplied bolts (longer than 8 mm; $\frac{5}{16}$ in) may damage the internal units.

NEVER install the MB-118 with non-supplied screws and bolts.

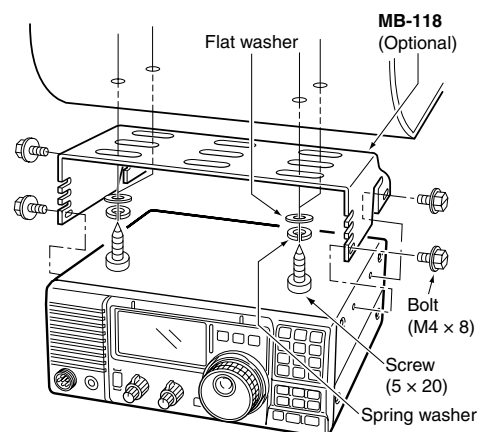

■ CR-338 HIGH STABILITY CRYSTAL UNIT

The CR-338 improves the total frequency stability of the receiver.

Installation

- ① Remove the bottom cover as shown in the diagram before.
- ② Disconnect W2 from J4401 (MAIN unit) and W3 from J4201 (MAIN unit).
- ③ Remove the 9 screws from the PLL unit, disconnect P4 from J201 (MAIN unit) and P2 from J401 (MAIN unit), then remove the PLL unit.

- ④ Remove the supplied internal crystal and replace it with the CR-338.
- ⑤ Return the PLL unit, plugs and flat cables to their original positions.
- ⑥ Adjust the reference frequency at C16 using a frequency counter, if desired.
 - Connect the frequency counter to P 2 (PLL unit).
- ⑦ Return the bottom cover to its original position.

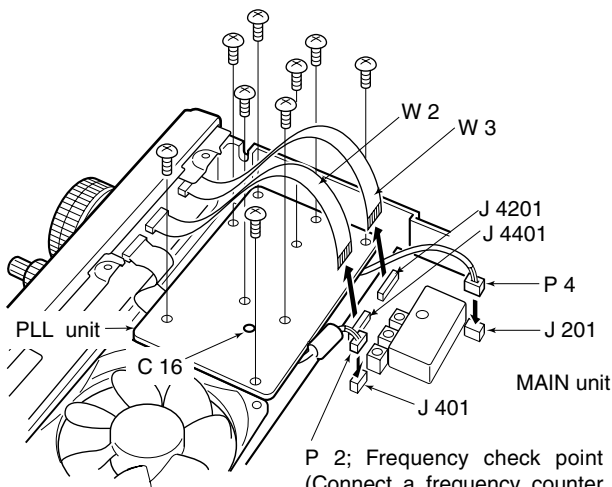

P 2; Frequency check point
(Connect a frequency counter
and adjust the frequency to
64.00000 MHz with C 16.)

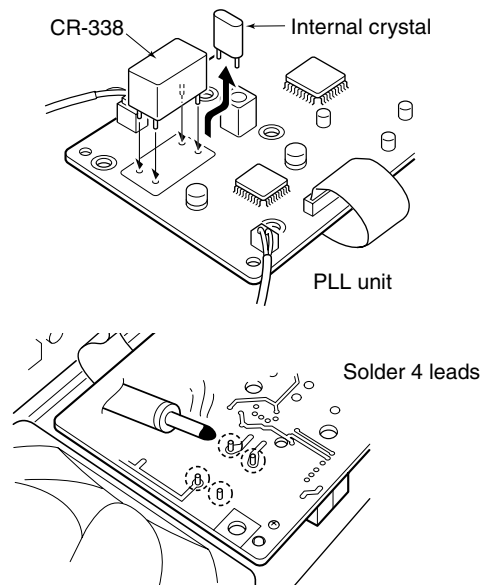

■ UT-106 DSP RECEIVE UNIT

The UT-106 provides AF DSP functions such as noise reduction and auto notch.

Installation

- ① Remove the bottom cover.
- ② Slide the insulating case onto the UT-106 as shown to the right. (Fig. 1)
- ③ Remove the connection cable (P2601) from J2602 on the MAIN unit. Connect the cable into J1 on the UT-106.
- ④ Plug the connection cable (P1) from the UT-106 to J2602 on the MAIN unit.
- ⑤ Plug the flat cable into J3 on the UT-106 and to J2603 on the MAIN unit.
 - Take care to observe the conductor direction.
- ⑥ Turn the UT-106 unit over. (Fig. 2)
 - You do not need to fix with an adhesive strip.
- ⑦ Put the UT-106 on the MAIN unit.
 - You do not need to fix with an adhesive strip.
 - Ensure that the extra cable from UT-106 is stored under the unit.
- ⑧ Return the bottom cover to its original position.

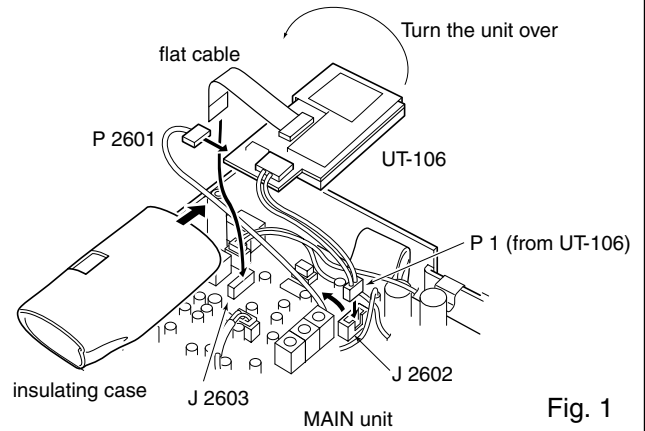

Fig. 1

- Turn the unit over

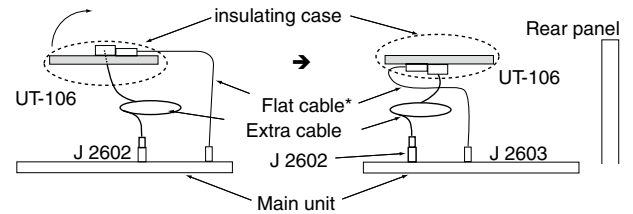

Fig. 2

* Supplied with UT-106

■ Optional IF filters

Several IF filters are available to select a desired selectivity. You can install 1 filter for the 455 kHz IF. Choose the appropriate filter for your operating needs. (pgs, 24–25)

Installation

- ① Remove the bottom cover as shown on page 48.
- ② Remove 7 screws, connection cable P1 from J1, P5 from J701, W4 from J4101 and W5 from J4001 and 2 Tr-clampers as shown in the diagram below.
- ③ Install the desired 455 kHz filter as shown in the diagram below.

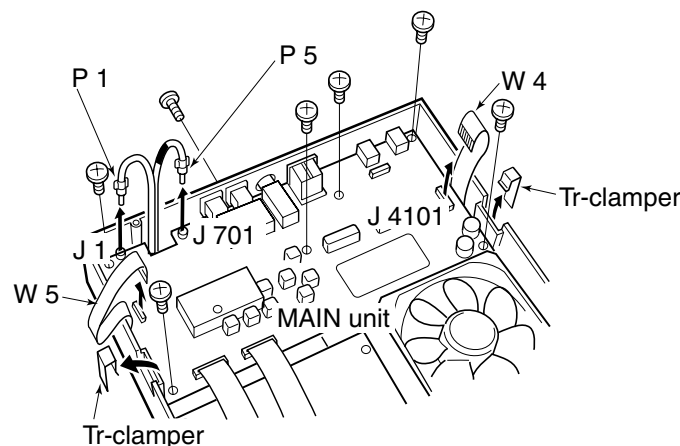

- ④ Mount the filter with the supplied washers and nuts.
- ⑤ Solder the 4 leads.
- ⑥ Return the MAIN unit and bottom cover to their original positions.

After installing the filter, select it in the Initial Set mode. (p. 47) Otherwise, the installed filter will not function properly.

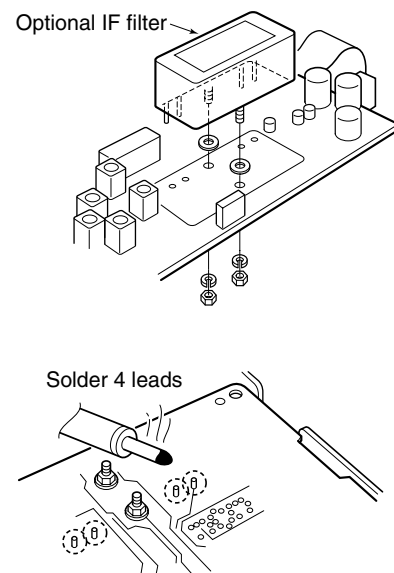

■ AT-180 INTERNAL SWITCH

The optional AT-180 has 3 operating settings. Select the suitable setting for your antenna system.

- ① Remove the top cover of the AT-180.
- ② Set the tuner switches to the desired positions according to the table below.

SW	Position	Operation
S1	A (default)	The tuner operating settings are set by S2 described below.
	B	THROUGH INHIBIT MODE The tuner tunes the antenna even when the antenna has poor SWR (up to VSWR 3:1 after tuning). In that case, manual tuning is necessary each time you change the frequency, although the tuner automatically starts tuning when the VSWR is higher than 3:1. This setting is called “ <i>through inhibit</i> .” However, the tuner is set to “ <i>through</i> ” if the VSWR is higher than 3:1 after tuning.
S2	C	TUNER SENSITIVE MODE The tuner tunes each time you transmit (except in the SSB mode). Therefore, the lowest SWR is obtained at any given time. In the SSB mode, the setting is the same as the “D” position below.
	D (default)	NORMAL MODE The tuner tunes when the SWR is higher than 1.5:1. Therefore, the tuner activates only when tuning is necessary.

• Specifications for the AT-180

- Frequency coverage: 1.9–54 MHz
- Input impedance: 50 Ω
- Maximum input: 120 W power
- Minimum tuning: 8 W power
- Matching impedance: 16.7–150 Ω (HF band)
20–125 Ω (50 MHz band)
- Tuning accuracy: Less than SWR 1.5:1
- Insertion loss: Less than 1.0 dB (after tuning)
- Power supply: 13.8 V DC/1 A (supplied from the transceiver’s ACC socket)
- Dimensions (mm/in): 167 (W) × 58.6 (H) × 225 (D) mm
6⁹/₁₆ (W) × 2⁵/₁₇ (H) × 8⁷/₈ (D) in
- Weight (approx.): 2.3 kg, 5 lb 1¹/₈ oz
- Supplied accessories: coaxial cable (1 m), ACC cable (DIN 13 pins)

• AT-180 inside top cover

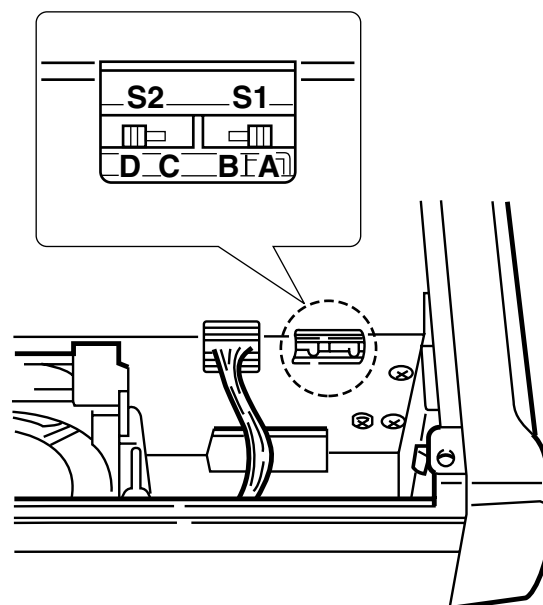

• Connector information for ACC 2 socket



PIN NO./NAME	DESCRIPTION
① 8 V	Regulated 8 V output. (10 mA maximum)
② GND	Connects to ground.
③ SEND	Input/output pin. Goes to ground when transmitting (20 mA maximum.) Transmits when grounded.
④ BAND	Band voltage output. (Varies with the selected band; 0 to 8.0 V.)
⑤ ALC	ALC output voltage (–4 to 0 V.)
⑥ NC	No connection.
⑦ 13.8V	13.8 V output when power is ON (1 A maximum.)

10 MAINTENANCE

■ Troubleshooting

The following chart is designed to help you correct problems which are not equipment malfunctions.

If you are not able to locate the cause of a problem or solve it through the use of this chart, contact your nearest Icom Dealer or Service Center.

	PROBLEM	POSSIBLE CAUSE	SOLUTION	REF.
POWER	Power does not come on when the [POWER] switch is pushed.	<ul style="list-style-type: none"> • DC power cable is improperly connected. • Fuse is blown. • Power supply is not turned ON. 	<ul style="list-style-type: none"> • Reconnect the DC power cable correctly. • Check for the cause, fix it and then replace the fuse with a spare one. (Fuses are in the DC power cable and the internal PA unit.) • Turn ON the power supply. 	p. 12 p. 53
	No sounds come from the speaker.	<ul style="list-style-type: none"> • Volume level is too low. • The squelch is closed. • The transceiver is in the transmitting mode. 	<ul style="list-style-type: none"> • Rotate [AF] clockwise to obtain a suitable listening level. • Rotate [RF/SQL] to around the 10 o'clock position to open, and then properly the squelch. • Turn off the transmit mode. 	p. 2 p. 2 p. 6
RECEIVE	Sensitivity is low.	<ul style="list-style-type: none"> • The antenna is not connected properly. • The antenna for another band is connected. • The antenna is not properly tuned. • The attenuator is activated. 	<ul style="list-style-type: none"> • Reconnect to the antenna connector. • Connect an antenna suitable for the operating frequency. • Hold down [TUNER] for 2 seconds to manually tune the antenna. • Push [ATT] to set "ATT" or to OFF. 	— — p. 3 p. 3
	Receive audio is distorted.	<ul style="list-style-type: none"> • The operating mode is not selected correctly. • The IF SHIFT function is activated. • The Noise blanker function is activated. • The preamp is activated. • If installed, the Noise Reduction function is activated and the [NR] control is set too high. 	<ul style="list-style-type: none"> • Select the correct operating mode. • Rotate SHIFT to the center position. • Push [NB] to turn OFF the function. • Push [P.AMP] to turn OFF the function. • Set the [NR] control for maximum readability. 	p. 20 p. 21 p. 21 p. 22 p. 23
	Transmitting is impossible.	<ul style="list-style-type: none"> • The operating frequency is outside the selected ham band. 	<ul style="list-style-type: none"> • Set the frequency within the selected ham band. 	p. 17
TRANSMIT	Output power is too low.	<ul style="list-style-type: none"> • [RF POWER] is set too low. • [MIC GAIN] is set too low. • The selected antenna is for a different band. • The antenna is not properly tuned. 	<ul style="list-style-type: none"> • Set [RF POWER] to a suitable level. • Set [MIC GAIN] to a suitable level. • Select an antenna suitable for the operating frequency. • Hold down [TUNE] for 2 seconds to manually tune the antenna. 	p. 42 p. 42 p. 10 p. 3
	No contact possible with another station.	<ul style="list-style-type: none"> • The RIT function is activated. • The Split frequency function is activated. 	<ul style="list-style-type: none"> • Push [RIT] to turn OFF the function. • Push [SPLIT] to turn OFF the function. 	p. 21 pp. 7, 31, 32
	Transmitted signals are distorted.	<ul style="list-style-type: none"> • [MIC GAIN] too high. • [COMP] function is activated. 	<ul style="list-style-type: none"> • Set [MIC GAIN] to a suitable level. • Turn OFF [COMP]. 	p. 2 p. 28
	Programmed scan does not stop.	<ul style="list-style-type: none"> • Squelch is open. • [RF/SQL] is assigned to RF gain control and squelch is open. 	<ul style="list-style-type: none"> • Set [RF/SQL] to the threshold point. • Reset [RF/SQL] control assigned and set it to the threshold point. 	p. 3 p. 26
SCAN	Programmed scan does not start.	<ul style="list-style-type: none"> • The same frequencies have been entered in scan edge memory channels P1 and P2. 	<ul style="list-style-type: none"> • Enter different frequencies in Scan Edge memory channels P1 and P2. 	p. 40
	Memory scan does not start.	<ul style="list-style-type: none"> • 2 or more memory channels have not been entered. 	<ul style="list-style-type: none"> • Enter 2 or more memory channels. 	p. 40
DISPLAY	The displayed frequency does not change when rotating the main dial.	<ul style="list-style-type: none"> • The dial lock function is activated. • A Quick Set mode screen is selected. • The internal CPU has malfunctioned. 	<ul style="list-style-type: none"> • Push [LOCK] to deactivate the function. • Push [SET] to exit the Quick Set mode. • Reset the CPU. 	p. 6 p. 41 p. 53

■ Fuse replacement

If a fuse blows, or the transceiver stops functioning, find the source of the problem, and repair it. Then replace the damaged fuse with a new, adequately rated fuse.

CAUTION: Turn the power OFF and disconnect the DC power cable from the transceiver before removing the transceiver's cover.

The IC-718 has 2 types of fuses installed for transceiver protection.

- DC power cable fuses ATQ 25 A
- Circuitry fuse FGB 4 A

DC POWER CABLE FUSE REPLACEMENT

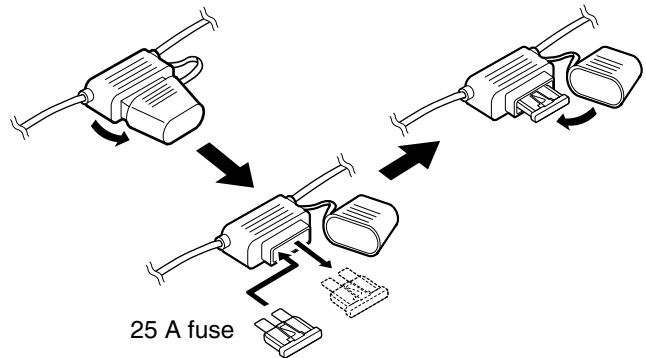

CIRCUITRY FUSE REPLACEMENT

The 13.8 V DC from the DC power source is applied to all units in the IC-718 through the circuitry fuse. This fuse is in the MAIN unit.

- ① Remove the top cover as shown on page 48.
- ② Replace the circuitry fuse as shown in the diagram to the right.
- ③ Replace the top cover.

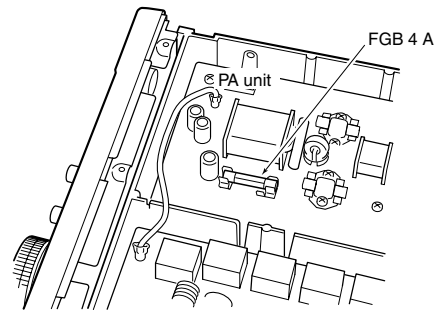

■ Resetting the CPU

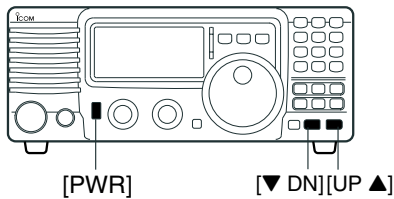

When the unit is new and you are applying power, or if the function seems to be displaying erroneous information, reset the CPU as follows:

- ① Make sure transceiver power is OFF.
- ② While pushing [UP ▲] and [▼ DN], push [PWR] to turn ON the power.
 - The internal CPU is reset.
 - The transceiver displays its initial VFO frequencies when resetting is complete.

Resetting **CLEARs** all entered content in Memory channels and returns entered values in the set mode to their defaults.

11 SPECIFICATIONS

◇ General

- Frequency coverage: *Receive*
0.03–29.999999 MHz*¹
Transmit
1.800– 1.999999 MHz*²
3.500– 3.999999 MHz*²
7.000– 7.300000 MHz
10.100–10.150000 MHz
14.000–14.350000 MHz
18.068–18.168000 MHz
21.000–21.450000 MHz
24.890–24.990000 MHz
28.000–29.700000 MHz
- *¹Guaranteed range: 0.5–29.999999 MHz
- *²Varies according to version
- Mode: USB, LSB, CW, RTTY, AM,
- Number of memory: 101 (99 regular, 2 scan edges) channels
- Frequency stability: Less than ± 200 Hz from 1 min. to 60 min. after power on. After that rate of stability less than ± 30 Hz/hr. at $+25^{\circ}\text{C}$ ($+77^{\circ}\text{F}$). Temperature fluctuations 0°C to $+50^{\circ}\text{C}$ ($+32^{\circ}\text{F}$ to $+122^{\circ}\text{F}$) less than ± 350 Hz.
- Power supply: 13.8 V DC $\pm 15\%$ requirement (negative ground)
- Current drain: *Receive*
(at 13.8 V DC) Standby 1.3 A
Max. audio 2.0 A
Transmit
Max. power 20.0 A
- Operatable temp. range: -10°C to $+60^{\circ}\text{C}$; $+14^{\circ}\text{F}$ to $+140^{\circ}\text{F}$
- Antenna connector: SO-239 (50 Ω)
- Dimensions: 240(W) \times 95(H) \times 239(D) mm (projections not included) $9\frac{7}{16}$ (W) \times $3\frac{3}{4}$ (H) \times $9\frac{13}{32}$ (D) in
- Weight (approximately): 3.8 kg; 8 lb 6 oz
- ACC connector: 13-pin
- REMOTE connector: 2-conductor 3.5 (d) mm ($\frac{1}{8}$ "

◇ Transmitter

- Output power:
SSB, CW, RTTY 2–100 W
AM 2–35 W
- Modulation system:
SSB Balanced modulation
AM Low level modulation

- Spurious emissions: Less than -50 dB below peak output power
- Carrier suppression: More than 40 dB
- Unwanted sideband: More than 50 dB
- Microphone connector: 8-pin connector (600 Ω)
- Key connector: 3-conductor 6.5 (d) mm ($\frac{1}{4}$ "
- SEND/ALC connector: Phono (RCA)

◇ Receiver

- Receive system: Double-conversion superheterodyne system
- Sensitivity:
(For all versions)
SSB/CW/RTTY (10 dB S/N)
0.16 μV (1.800 – 29.999999 MHz)
AM (10 dB S/N)
13 μV (0.500 – 1.799999 MHz)
2.0 μV (1.800 – 29.999999 MHz)

(For European versions)
SSB (BW=2.4 kHz, 12 dB SINAD)
10 dB μV emf (1.800 – 2.999999 MHz)
0 dB μV emf (3.000 – 29.999999 MHz)
AM (BW=6 kHz, 60% Modulation, 12 dB SINAD)
16 dB μV emf (1.800 – 2.999999 MHz)
6 dB μV emf (3.000 – 29.999999 MHz)
- Squelch sensitivity (threshold):
SSB, CW, RTTY Less than 5.6 μV
- Selectivity:
SSB, CW, RTTY More than 2.1 kHz/ -6 dB
Less than 4.5 kHz/ -60 dB
AM More than 6 kHz/ -6 dB
Less than 20 kHz/ -40 dB
- Spurious and image rejection ratio:
More than 70 dB
(1.8–29.999999 MHz)
- RIT variable range: ± 1200 Hz
- Audio output power: More than 2.0 W at 10% distortion with an 8 Ω load (at 13.8 V DC)
- PHONES connector: 3-conductor 6.35 (d) mm ($\frac{1}{4}$ "
- External SP connector: 2-conductor 3.5 (d) mm ($\frac{1}{8}$ " /8 Ω

All stated specifications are typical and subject to change without notice or obligation.

IC-PW1/EURO HF + 50 MHz 1 KW LINER AMPLIFIER



Full-duty 1 kW linear amplifier including an automatic antenna tuner. Has automatic tuning and band selection capability. Full break-in (QSK) operation is possible. The amplifier/power supply unit and the remote control unit can be separated.

AT-180 HF + 50 MHz AUTOMATIC ANTENNA TUNER



Fully automatic antenna tuner with preset memories for each 100 kHz. Unique "Automatic tuner on" function is available. See p. 51 for AT-180 specifications.

AH-4 HF + 50 MHz AUTOMATIC ANTENNA TUNER



Specially designed to tune a long wire antenna for portable or mobile HF operation. The PTT tuner start function provides simple operation.

- Input power rating: 120 W

AH-2b ANTENNA ELEMENT



A 2.5 m long antenna element for mobile operation with the AH-4.

- Frequency coverage: 3.5–28 MHz bands with the AH-4

AH-740 AUTOMATIC TUNING ANTENNA



High performance, automatic high-speed tuning antenna.

- Frequency coverage
With 1.54 m whip antenna: 2.5 MHz–29.9999 MHz
With AH-5NV (NVIS kit): 2.2 MHz–29.9999 MHz

SM-30 DESKTOP MICROPHONE



Includes a low frequency cut function.

SM-50 DESKTOP MICROPHONE



Unidirectional, dynamic microphone for base station operation. Includes [UP]/ [DOWN] switches, a low cut switch and mic gain control.

HM-36 HAND MICROPHONE



Hand microphone equipped with [UP]/ [DOWN] switches. Same as supplied.

SP-23 EXTERNAL SPEAKER



4 audio filters, headphone jack, can be connected to 2 transceivers.

- Input impedance: 8 Ω
- Max. input power: 4 W

PS-126 DC POWER SUPPLY



- Output voltage: 13.8 V DC
- Max. output current: 25 A

FL-222 and FL-257 455 kHz FILTERS



- FL-222: 1.8 kHz/–6 dB (SSB narrow)
- FL-257: 3.3 kHz/–6 dB (SSB wide)

12 OPTIONS

UT-106 DSP RECEIVE UNIT



Provides AF DSP functions such as noise reduction and auto notch.

MB-23 CARRYING HANDLE



Carrying handle, convenient for portable operation.

MB-118 MOBILE MOUNTING BRACKET

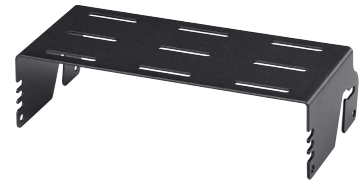

For mounting the transceiver in a vehicle.

AH-710 FOLDED DIPOLE ANTENNA

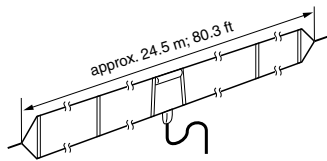

Covers from 1.9–30 MHz bands. Has an SO-239 connector. 30 m (98.4 ft) coaxial cable with PL-259 connector is supplied.

CT-17 CI-V LEVEL CONVERTER



For remote receiver control using a personal computer. You can change frequencies, operating mode, Memory channels and so on.

CR-338 HIGH-STABILITY CRYSTAL UNIT



Contains a temperature-compensating oven heater and crystal unit for improved frequency stability.

- Frequency stability: ± 0.5 ppm

OPC-599 ADAPTER CABLE

13-pin, ACC connector to 7-pin + 8-pin ACC connector.

AH-5NV NVIS KIT

Approximately 4.5 m (14.8 ft) long antenna for the AH-740.

Frequency coverage with AH-740: 2.2 MHz – 29.9999 MHz

13 CONTROL COMMAND

• Command table

Command	Sub command	Description
00	—	Send frequency data
01	—	Send mode data
02	—	Read Upper/Lower frequencies
03	—	Read frequencies
04	—	Read operating mode
05	—	Set operating frequency
06	—	Set mode
07	—	Set VFO
	00	Set VFO A
	01	Set VFO B
	A0	VFO A=B
08	B0	VFO A ⇄ B
	—	Set Memory
09	—	Set Memory CH
	—	Memory write
0A	—	Memory ⇄ VFO
0B	—	Memory clear
0E	00	Scan stop
	01	Prog/Memo Scan Start
	D0	Resume OFF
	D3	Resume ON
0F	00	SPLIT OFF
	01	SPLIT ON
10	—	Set TS
11	—	ATT
14	01	AF Gain
	02	RF Gain
	03	SQL Level
	06	NR Level
	09	CW Pitch
	0A	RF Power
	0B	MIC Gain
	0C	KEY Speed
15	0F	BK-IN Delay
	01	Read SQL Open/Close
16	02	Read SIG (S-meter) level
	02	PRE-AMP
16	22	NB
	40	NR
	41	Auto Notch
	44	COMP
	46	VOX
	47	BK-IN
19	00	Read ID

For amateur base station installations, it is recommended that the forwards clearance in front of the antenna array is calculated relative to the EIRP (Effective Isotropic Radiated Power). The clearance height below the antenna array can be determined in most cases from the RF power at the antenna input terminals.

As different exposure limits have been recommended for different frequencies, a relative table shows a guideline for installation considerations.

Below 10 MHz, the recommended limits are specified in terms of V/m or A/m fields as they are likely to fall within the near-field region. Similarly, at antennae may be physically short in terms of electrical length and that the installation will require some antenna matching device which can create high intensity magnetic fields. Analysis of such MF installations is best considered in association with published guidance notes such as the FCC OET Bulletin 65 Edition 97-01 and its annexes relative to amateur transmitter installations. Further information can be found at <http://www.arrl.org/>

• Typical amateur radio installation

Exposure distance assumes that the predominant radiation pattern is forwards and that radiation vertically downwards is at unity gain (sidelobe suppression is equal to main lobe gain). This is true of almost every gain antenna today. Exposed persons are assumed to be beneath the antenna array and have a typical height to 1.8 m.

The figures assume the worst case emission of constant carrier.

For the bands 10 MHz and higher the following power density limits are recommended :

10–30 MHz 2 W/sq m

Watts (EIRP)/ Clearance heights

1	2.1 (m)
10	2.8
25	3.4
100	5
1000	12

Watts (EIRP)/ Forward clearance

100	2 (m)
1,000	6.5
10,000	20
100,000	65

In all cases any possible risk depends on the transmitter being activated for long periods. (actual recommendation limits are specified as an average of 6 minutes) Normally the transmitter is not active for long periods of time. Some radio licenses will require that a timer circuit automatically cuts the transmitter after 1–2 minutes etc.

Similarly some types of transmitter, SSB, CW, AM, etc. have a lower 'average' output power and the perceived risk is even lower.

List of Country codes (ISO 3166-1)

	Country	Codes		Country	Codes
1	Austria	AT	18	Liechtenstein	LI
2	Belgium	BE	19	Lithuania	LT
3	Bulgaria	BG	20	Luxembourg	LU
4	Croatia	HR	21	Malta	MT
5	Czech Republic	CZ	22	Netherlands	NL
6	Cyprus	CY	23	Norway	NO
7	Denmark	DK	24	Poland	PL
8	Estonia	EE	25	Portugal	PT
9	Finland	FI	26	Romania	RO
10	France	FR	27	Slovakia	SK
11	Germany	DE	28	Slovenia	SI
12	Greece	GR	29	Spain	ES
13	Hungary	HU	30	Sweden	SE
14	Iceland	IS	31	Switzerland	CH
15	Ireland	IE	32	Turkey	TR
16	Italy	IT	33	United Kingdom	GB
17	Latvia	LV			

Version and Frequency coverage

EUR (#43)			
Tx		Rx	
1.800000	–	1.999999	0.500000 – 29.999999
3.500000	–	3.800000	
7.000000	–	7.100000	
10.100000	–	10.150000	
14.000000	–	14.350000	
18.068000	–	18.168000	
21.000000	–	21.450000	
24.890000	–	24.990000	
28.000000	–	29.700000	

(Unit: MHz)

INDEX

NUMBERS

1 Hz and 10 Hz tuning steps 19

A

ACC SOCKET INFORMATION 7
Advanced connections 11
AH-4 setting example 29
AM Noise blanker 45
ANF (Automatic Notch Filter) function 23
Antenna SWR 9
Anti VOX level 42
AT-180 internal switch 51
Attenuator 22
Automatic tuner start 29
Auto TS 45
Auto tune 46
AUTO TUNE 29

B

Band edge beep 44
Band selection 18
Band Stacking Register 18
Beep 44
Beep level 44
BK-IN 42
BK-IN delay 43

C

Carrying handle 48
Channels (Scan) 39
CIRCUITRY FUSE REPLACEMENT 53
CI-V 731 mode 47
CI-V address 47
CI-V baud rate 46
CI-V connection example 57
CI-V Transceive 47
Command table 58
Connecting a linear amplifier 13
Connecting an antenna 9
CONNECTING A NON-ICOM DC POWER SUPPLY 12
CONNECTING A NON-ICOM LINER AMPLIFIER 13
CONNECTING A VEHICLE BATTERY 12
CONNECTING THE AH-4 14
CONNECTING THE AH-740 14
CONNECTING THE AT-180 14
CONNECTING THE IC-PW1/EURO 13
Connecting the Power supply 12
CONNECTING THE PS-126 DC POWER SUPPLY 12
Connection for AFSK 33
Connection for CW 31
Connection for RTTY (FSK) 33
CONTROL COMMAND 57
CR-338 high stability crystal unit 49
CW operation 31

CW pitch 42
CW pitch control 32
CW reverse mode 32

D

Data format 57
DC POWER CABLE FUSE REPLACEMENT 53
Dial Lock function 19
Differences between the VFO mode and
the Memory mode 16
Dimmer 43
DISPOSAL iii
DSP function 23

E

Electronic CW keyer 32
Entering a frequency from the keypad 17
Entering data in the Memory mode 36
Entering data in the VFO mode 36
Expanded filter selection 25, 47
Expanded filter selection "on" 25
EXPLICIT DEFINITIONS ii
External antenna tuners 14

F

FCC INFORMATION iii
Filter image 24
Filter selection 24
Filter selection table 24
Filter selection (Wide/Narrow) 47
Filter setting 25
For general coverage receiver use 17
Frequency setting 17
FREQUENCY SETTINGS 15
Front panel 2
Front panel (Microphone) 10
Front panel (Microphone and headphones) 11
Function display 5
Function for CW 31
Function for receive 21
Function for RTTY 33
Function for transmit 27
Fuse replacement 53

G

General (Set Mode) 41
Grounding 9

H

HM-36 SCHEMATIC DIAGRAM 8

I	
IF shift function	21
IF SHIFT OPERATION EXAMPLE	21
IMPORTANT	ii
Initial Set mode items	44
Initial Set mode operation	41
Initial settings	15
INSTALLATION AND CONNECTIONS	9, 48
INSTALLATION NOTES	59
Installing the MB-118 MOBILE MOUNTING BRACKET ..	48
K	
Key ratio	43
Key speed	43
Key type	45
L	
List of Country codes (ISO 3166-1)	59
M	
MAINTENANCE	52
Measuring SWR	26
Memory channel entry	36
Memory channels	35
Memory channel selection	35
Memory clearing	38
MEMORY OPERATION	35
Memory scan operation	40
Meter function	27
Meter peak hold	22, 45
Mic gain	42
Microphone compressor	28
MICROPHONE CONNECTOR	8
Microphone (HM-36)	8
Mode selection	20
Mounting bracket	48
N	
Narrow filter setting	25
Narrow filter setting table	25
Noise Blanker	22
NR (Noise Reduction) function	23
O	
Opening the transceiver's case	48
OPERATING MODE SELECTION	20
Optional AT-180 AUTOMATIC ANTENNA TUNER operation	29
Optional external tuner operation	30
Optional filter	47
Optional filter selection	25
Optional filter setting	25
Optional filter variations	24
Optional IF filters	50
OPTIONS	55
Output power and microphone gain	27
P	
Paddle operation from front panel MIC connector ..	32
PANEL DESCRIPTION	2
Preamp	21
PRECAUTIONS	ii
Preparation (Scan)	39
Programmable tuning steps	18
Programmed scan operation	40
PTT tune	46
Q	
Quick Set mode items	42
Quick Set mode operation	41
R	
Rear panel	6
Rear panel (Basic connection)	10
Rear panel (Optional products and external equipment)	11
RECEIVE AND TRANSMIT	20
Remote jack (CI-V) information	57
Required connections	10
Resetting the CPU	15, 53
RF gain and Squelch	20
RF power	42
[RF/SQL] control priority	20
RF/SQL VR	44
RIT function	21
RTTY (AFSK) operation	34
RTTY (FSK) operation	34
RTTY mark tone	43
RTTY reverse mode	34
RTTY shift	43
S	
Scan resume	45
Scan resume ON/OFF	39
SCANS	39
Scan speed	39, 45
Scan types	39
Selecting a location	9
SET MODE	41
Setting the electronic keyer	32
Setting the microphone gain	27
Setting the output power	27
Shift frequency	34

INDEX

Side-tone level	44
SPECIFICATIONS	54
Speech language.....	46
Speech S-meter level	46
Speech speed.....	46
Split frequency operation.....	26
Squelch condition (Scan).....	39
SUPPLIED ACCESSORIES.....	iv
SWR	26

T

TABLE OF CONTENTS.....	1
Through inhibit.....	29
Tone frequency.....	34
Transferring data to the VFO	37
Transferring in the Memory mode.....	38
Transferring in VFO mode.....	37
Troubleshooting	52
[TS] SWITCH FLOW CHART	19
Tuner sensitive condition	29
Tuner type.....	46

U

Unpacking.....	9
Using [MAIN DIAL]	17
Using the keypad.....	35
Using the [UP] or [DN] keys.....	35
UT-106 DSP RECEIVE UNIT	50, 51

V

Version and Frequency coverage	59
VFO description.....	16
VOX delay.....	42
VOX gain.....	42
VOX operation	28

W

When set as the [RF] control	20
When set as the [RF/SQL] control.....	20
When set as the [SQL] control.....	20
Wide filter setting.....	25
Wide filter setting table	25
Wide/narrow filter selecting	25

Count on us!

IC-718 #43
(EUR-02)

IC-718 #63
(EUR-03)

< Intended Country of Use >

■AT ■BE ■CY ■CZ ■DK ■EE
■FI ■FR ■DE ■GR ■HU ■IE
■IT ■LV ■LT ■LU ■MT ■NL
■PL ■PT ■SK ■SI ■ES ■SE
■GB ■IS ■LI ■NO ■CH ■BG
■RO ■TR ■HR