

ICOM ICOM INCORPORATED

Some components subject to change for an improvement without notice.

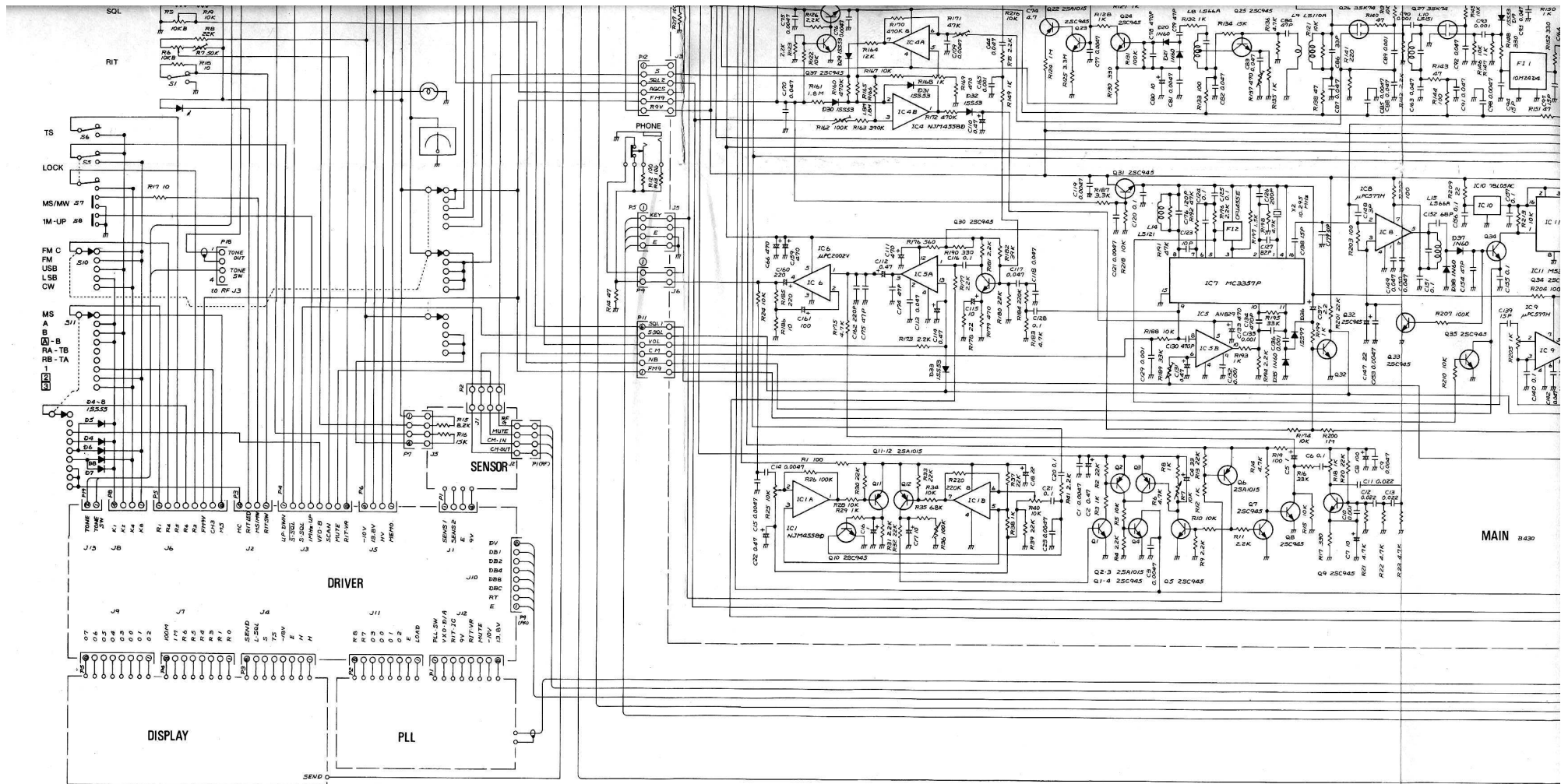

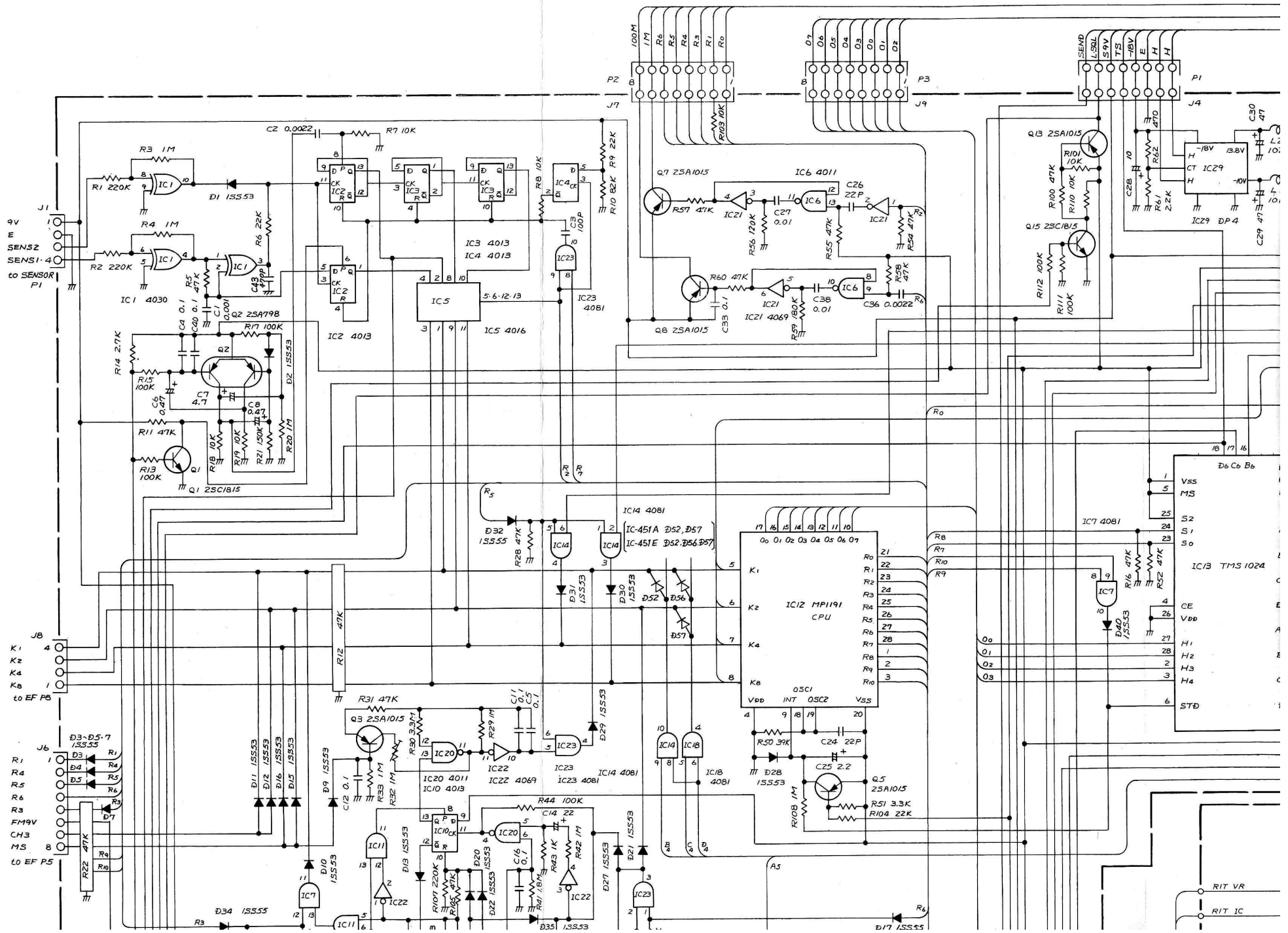

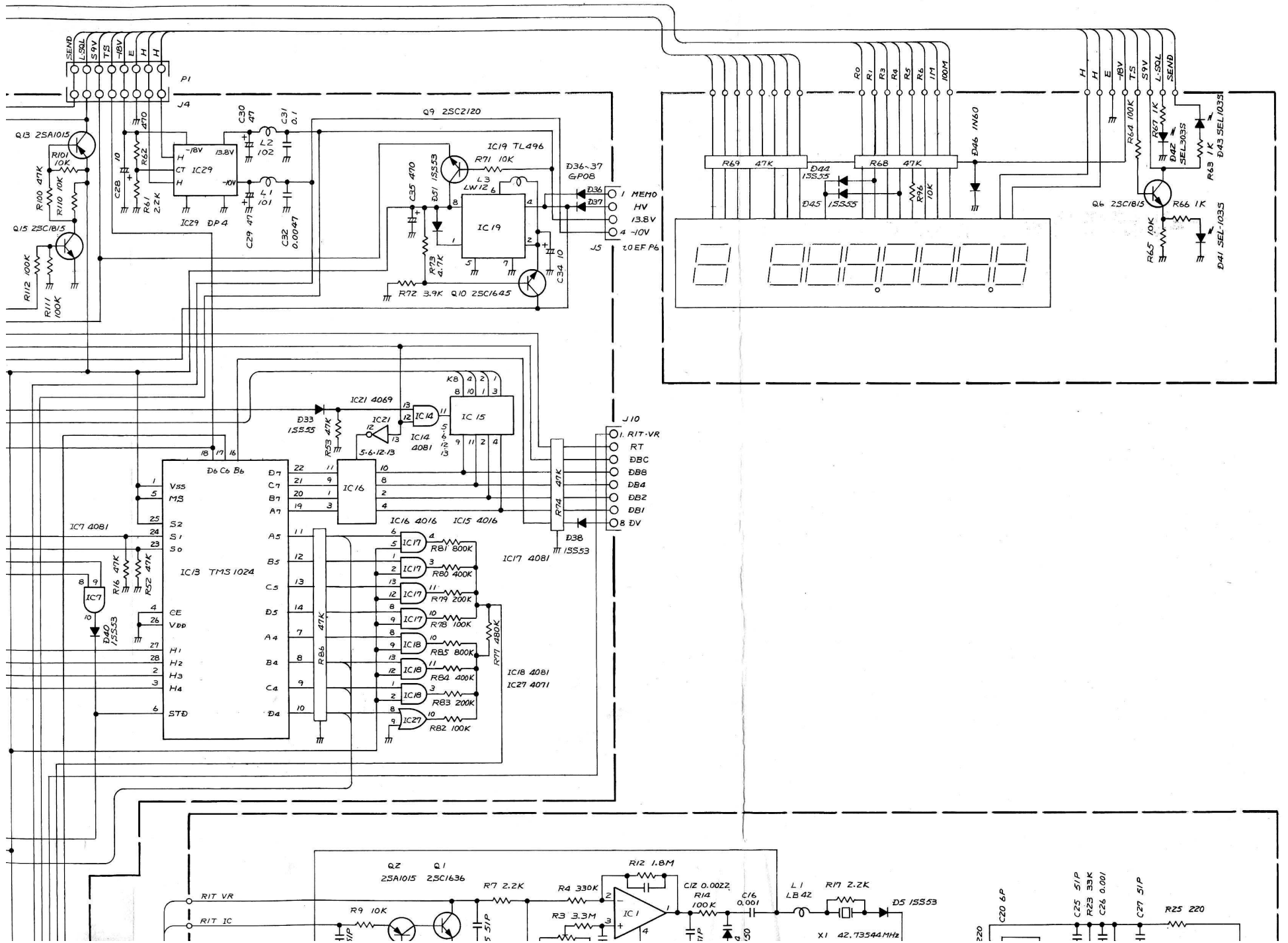

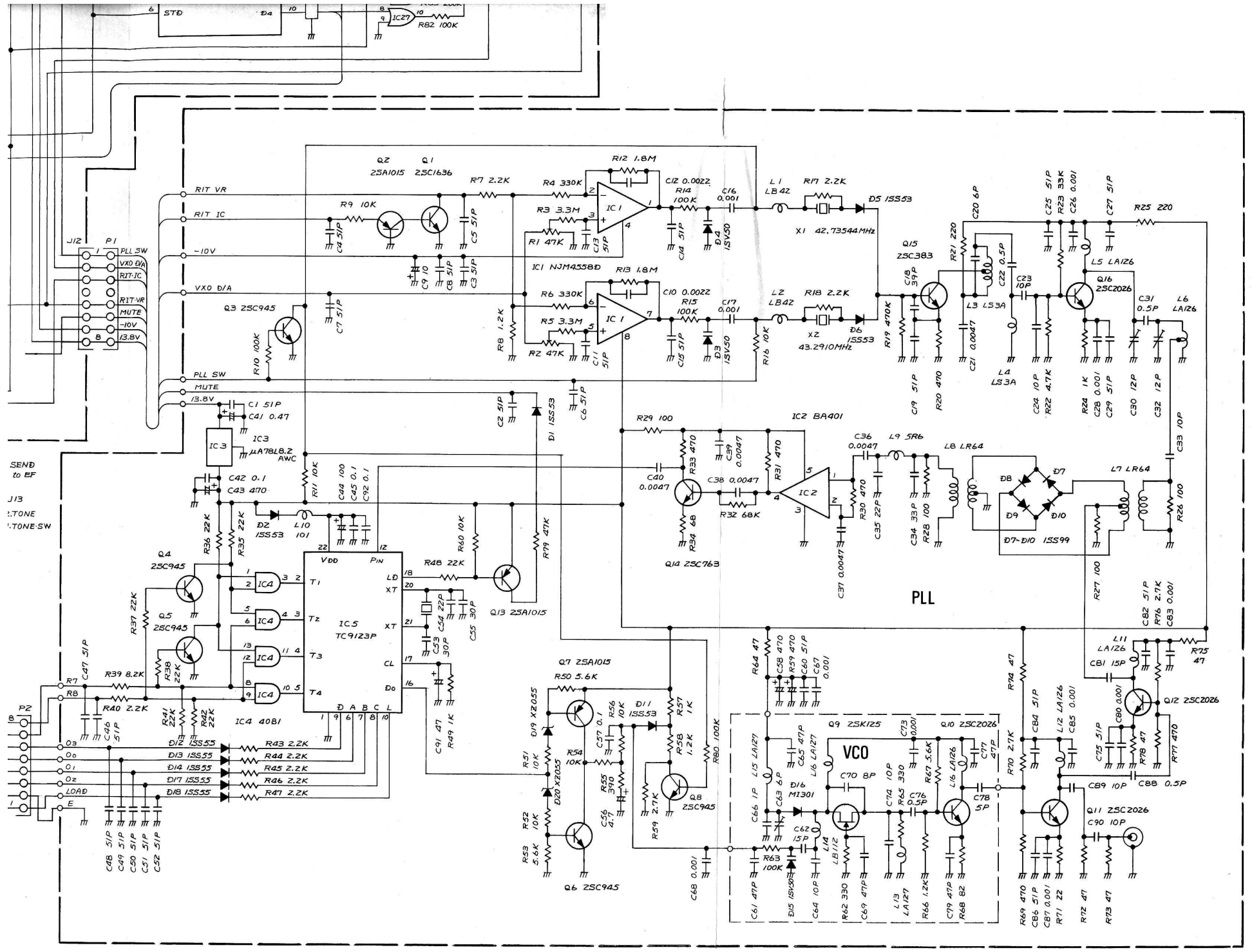

SEND TO EF
J13
TONE
TONE-SW

P1
PLL SW
VXO B/A
RIT-IC
RIT-VR
MUTE
-10V
+3.8V

IC3
4A78L8.2
AWC

IC4 4081
R43 2.2K
R44 2.2K
R45 2.2K
R46 2.2K
R47 2.2K
D12 ISS55
D13 ISS55
D14 ISS55
D17 ISS55
D18 ISS55

Q2
2SA1015
2SC1636

Q3 2SC945

Q4 2SC945

Q5 2SC945

Q6 2SC945

Q7 2SA1015

Q8 2SC945

Q1
2SA1015
2SC1636

Q5
2SC383

Q13
2SA1015

Q14
2SC763

Q15
2SC383

Q16
2SC2026

Q17
2SC2026

IC1
NJM4558D

IC2
BA401

IC3
TC9123P

IC4
4081

IC5
TC9123P

IC6
4081

IC7
4081

IC8
4081

D5
ISS53

D6
ISS53

D7-D10
ISS99

D11
ISS53

D12
ISS55

D13
ISS55

D14
ISS55

D15
ISS55

L1
LB42

L2
LB42

L3
LS3A

L4
LS3A

L5
LA126

L6
LA126

L7
LR64

L8
LR64

L9
5R6

L10
LA126

L11
LA126

L12
LA126

L13
LA127

L14
LA127

L15
LA127

L16
LA127

L17
LA127

L18
LA127

L19
LA127

L20
LA127

L21
LA127

L22
LA127

L23
LA127

L24
LA127

L25
LA127

L26
LA127

L27
LA127

L28
LA127

L29
LA127

L30
LA127

L31
LA127

L32
LA127

L33
LA127

L34
LA127

L35
LA127

L36
LA127

L37
LA127

L38
LA127

L39
LA127

L40
LA127

L41
LA127

L42
LA127

L43
LA127

L44
LA127

L45
LA127

L46
LA127

L47
LA127

L48
LA127

L49
LA127

L50
LA127

L51
LA127

L52
LA127

L53
LA127

L54
LA127

L55
LA127

L56
LA127

L57
LA127

L58
LA127

L59
LA127

L60
LA127

L61
LA127

L62
LA127

L63
LA127

L64
LA127

L65
LA127

L66
LA127

L67
LA127

L68
LA127

L69
LA127

L70
LA127

L71
LA127

L72
LA127

L73
LA127

L74
LA127

L75
LA127

L76
LA127

L77
LA127

L78
LA127

L79
LA127

L80
LA127

L81
LA127

L82
LA127

L83
LA127

L84
LA127

L85
LA127

L86
LA127

L87
LA127

L88
LA127

L89
LA127

L90
LA127

L91
LA127

L92
LA127

L93
LA127

L94
LA127

L95
LA127

L96
LA127

L97
LA127

L98
LA127

L99
LA127

L100
LA127

L101
LA127

L102
LA127

L103
LA127

L104
LA127

L105
LA127

L106
LA127

L107
LA127

L108
LA127

L109
LA127

L110
LA127

L111
LA127

L112
LA127

L113
LA127

L114
LA127

L115
LA127

L116
LA127

L117
LA127

L118
LA127

L119
LA127

L120
LA127

L121
LA127

L122
LA127

L123
LA127

L124
LA127

L125
LA127

L126
LA127

L127
LA127

L128
LA127

L129
LA127

L130
LA127

L131
LA127

L132
LA127

L133
LA127

L134
LA127

L135
LA127

L136
LA127

L137
LA127

L138
LA127

L139
LA127

L140
LA127

L141
LA127

L142
LA127

L143
LA127

L144
LA127

L145
LA127

L146
LA127

L147
LA127

L148
LA127

L149
LA127

L150
LA127

L151
LA127

L152
LA127

L153
LA127

L154
LA127

L155
LA127

L156
LA127

L157
LA127

L158
LA127

L159
LA127

L160
LA127

L161
LA127

L162
LA127

L163
LA127

L164
LA127

L165
LA127

L166
LA127

L167
LA127

L168
LA127

L169
LA127

L170
LA127

L171
LA127

L172
LA127

L173
LA127

L174
LA127

L175
LA127

L176
LA127

L177
LA127

L178
LA127

L179
LA127

L180
LA127

L181
LA127

L182
LA127

L183
LA127

L184
LA127

L185
LA127

L186
LA127

L187
LA127

L188
LA127

L189
LA127

L190
LA127

L191
LA127

L192
LA127

L193
LA127

L194
LA127

L195
LA127

L196
LA127

L197
LA127

L198
LA127

L199
LA127

L200
LA127

L201
LA127

L202
LA127

L203
LA127

L204
LA127

L205
LA127

L206
LA127

L207
LA127

L208
LA127

L209
LA127

L210
LA127

L211
LA127

L212
LA127

L213
LA127

L214
LA127

L215
LA127

L216
LA127

L217
LA127

L218
LA127

L219
LA127

L220
LA127

L221
LA127

L222
LA127

L223
LA127

L224
LA127

L225
LA127

L226
LA127

L227
LA127

L228
LA127

L229
LA127

L230
LA127

L231
LA127

L232
LA127

L233
LA127

L234
LA127

L235
LA127

L236
LA127

L237
LA127

L238
LA127

L239
LA127

L240
LA127

L241
LA127

L242
LA127

L243
LA127

L244
LA127

L245
LA127

L246
LA127

L247
LA127

L248
LA127

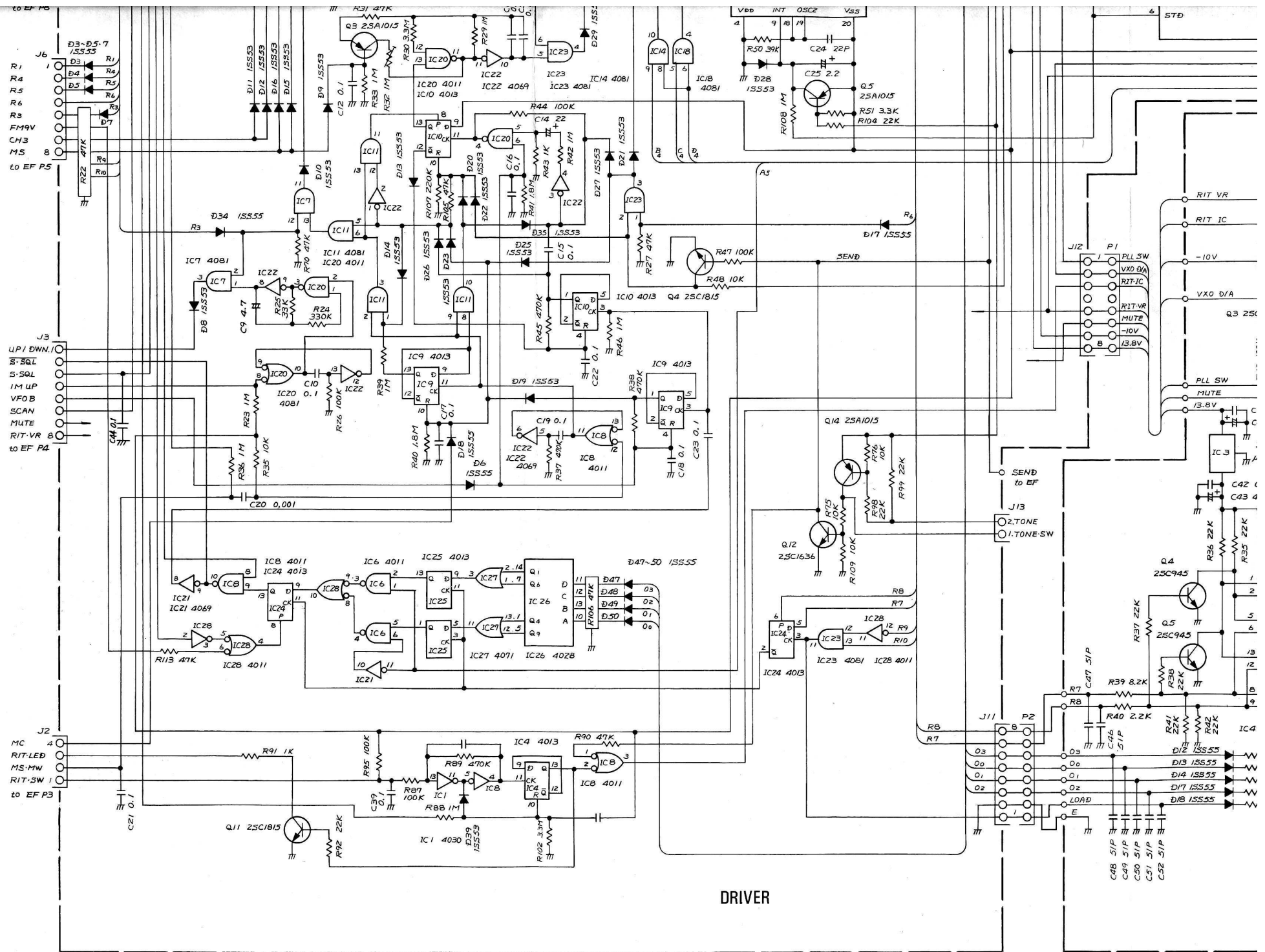

DRIVER

OUT

- MIC GAIN BOARD
- IC-451E ONLY

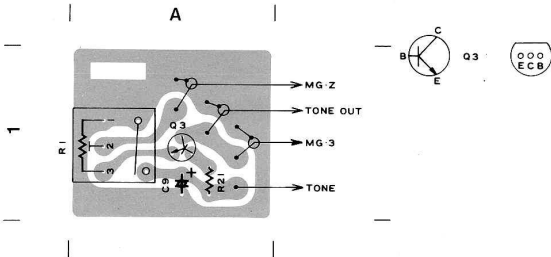

TONE CALL UNIT

- IC-451E ONLY

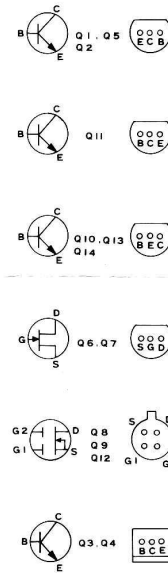
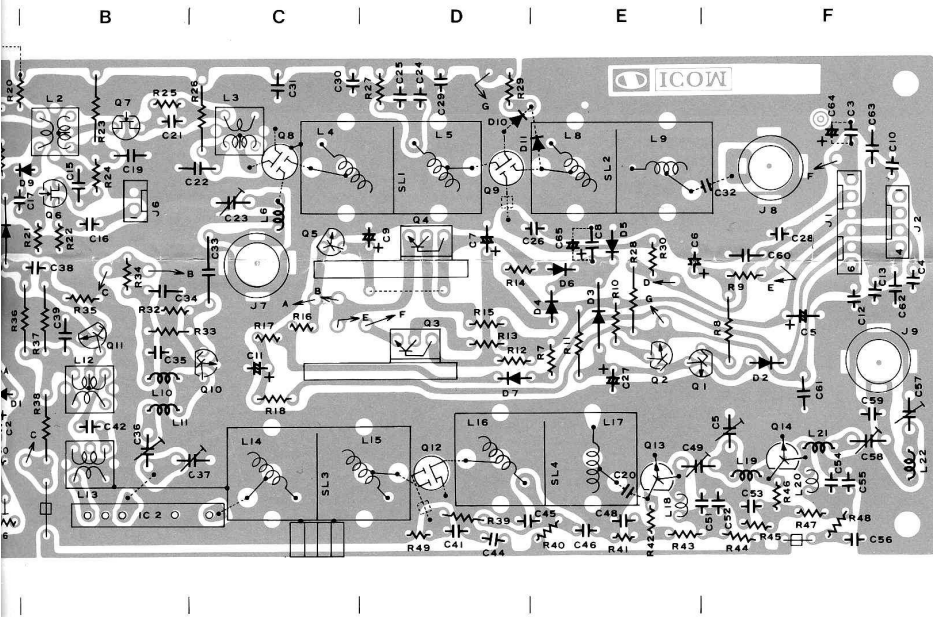
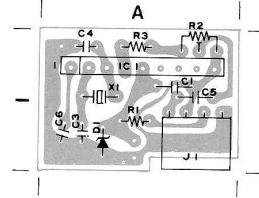

UNIT

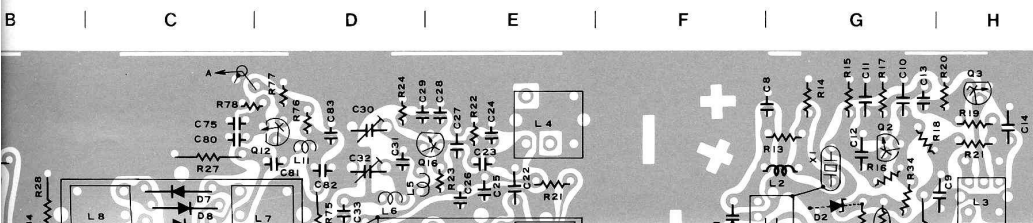

PLL UNIT

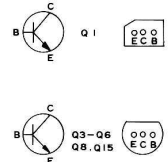

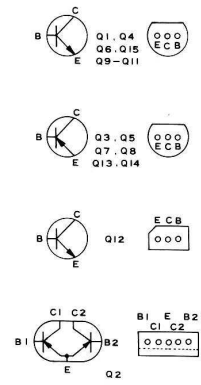
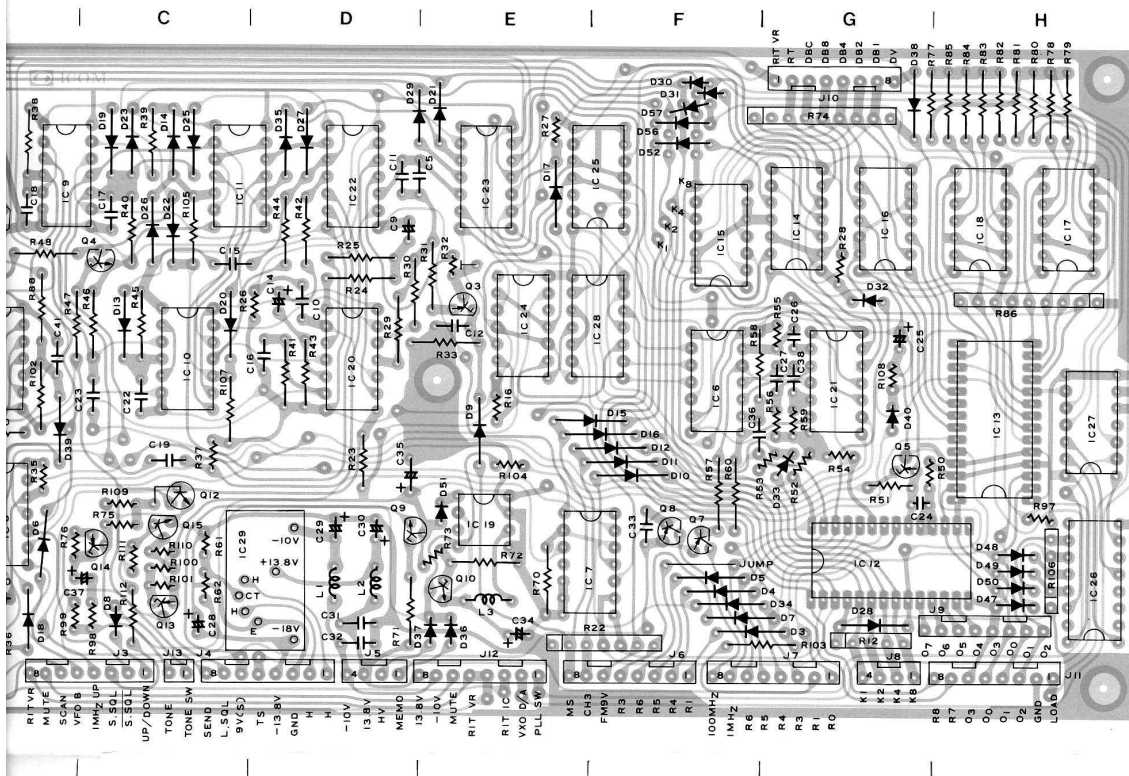

UNIT LAYOUT

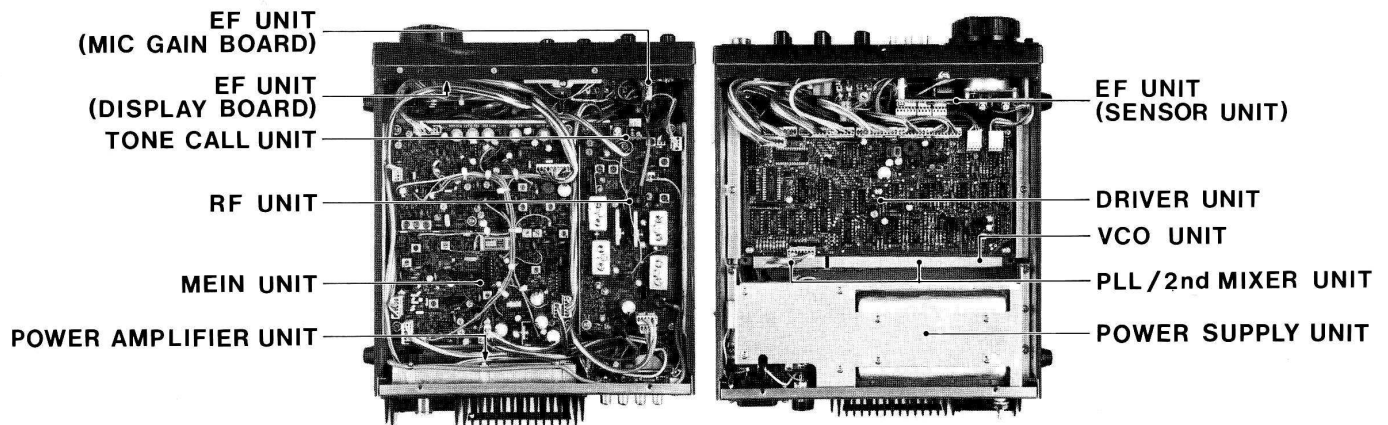

ICOM INCORPORATED

Some components subject to change for an improvement without notice.

Printed in Japan

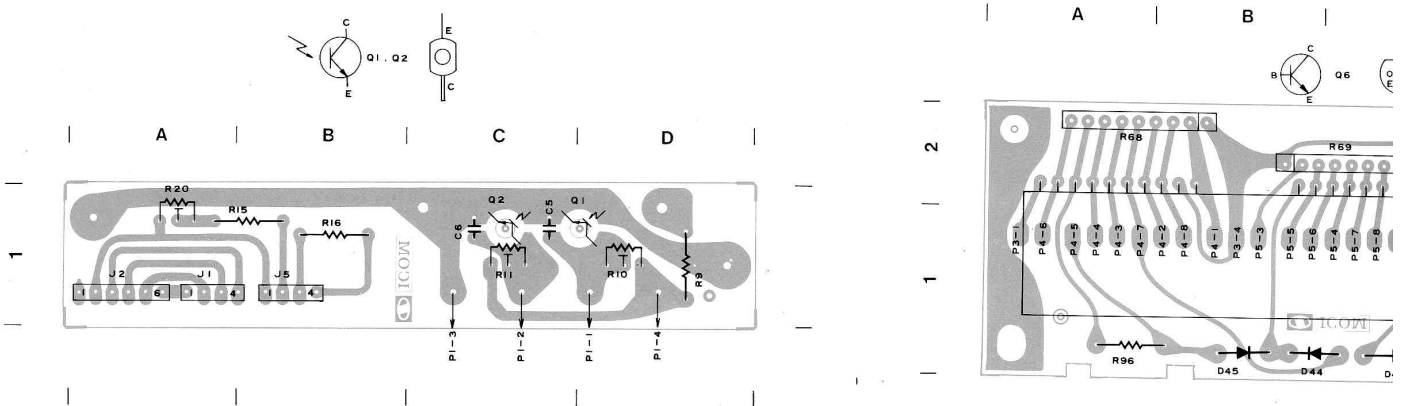
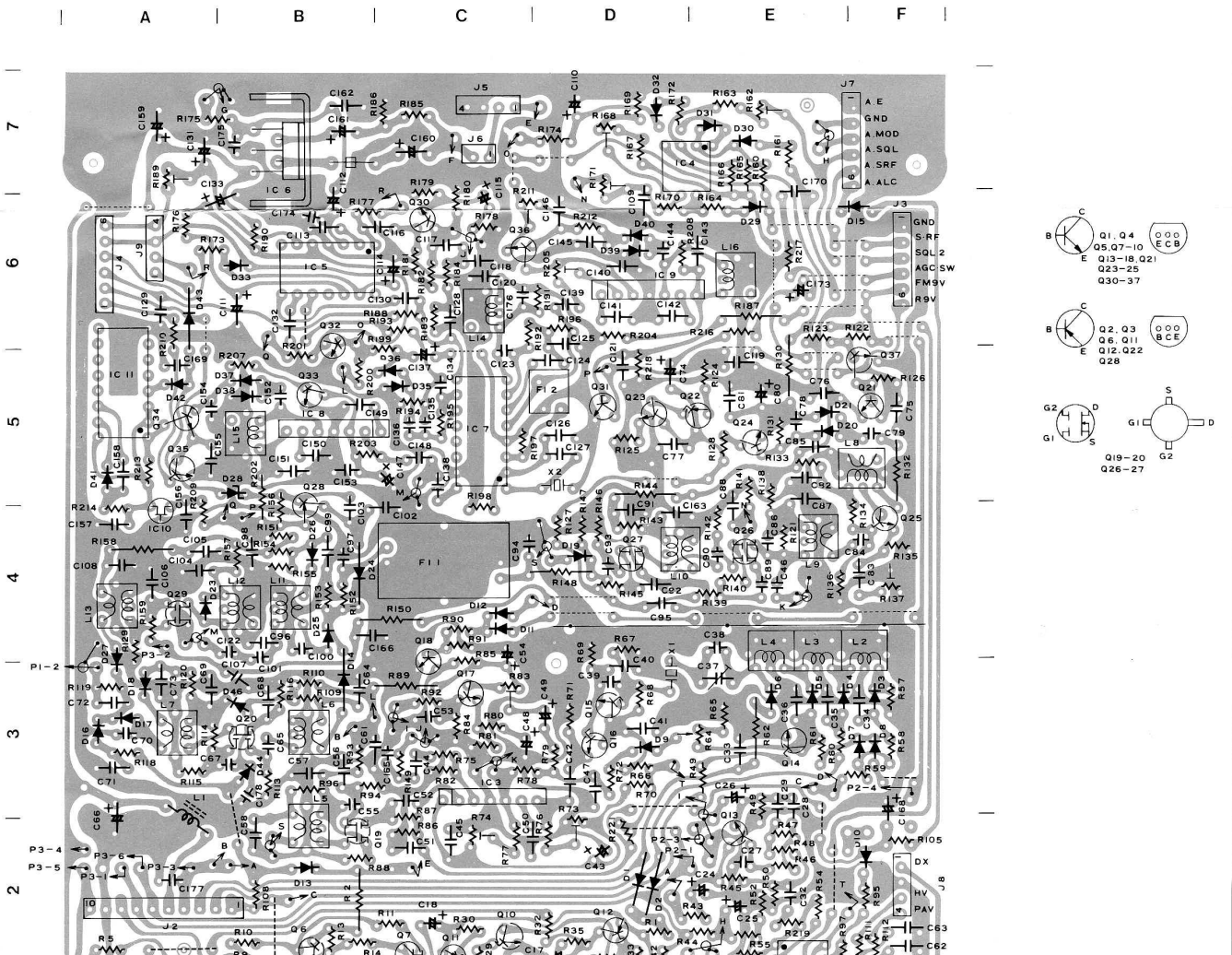
EF UNIT
■ DISPLAY BOARD
■ SENSOR BOARD

MAIN UNIT

■ DISPLAY BOARD

■ MIC GAIN BOA

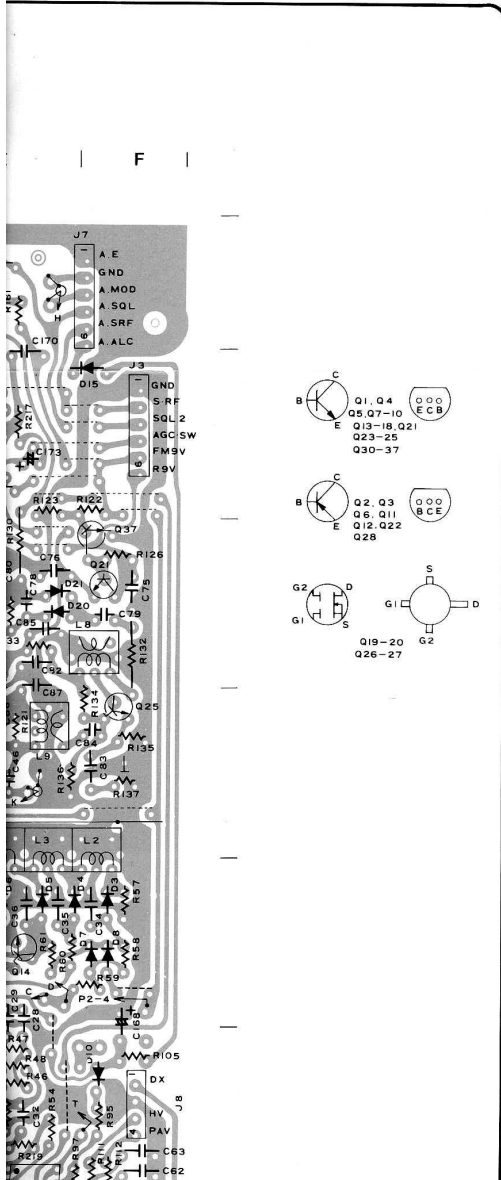
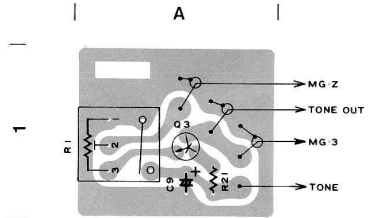
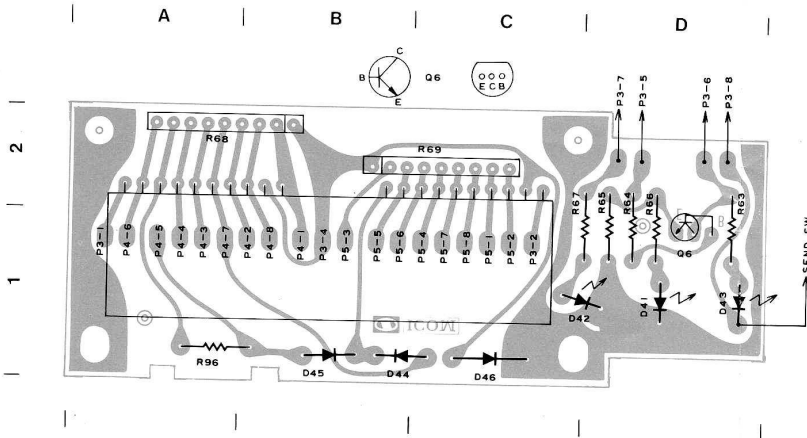
■ IC-451E ONLY



RF UNIT

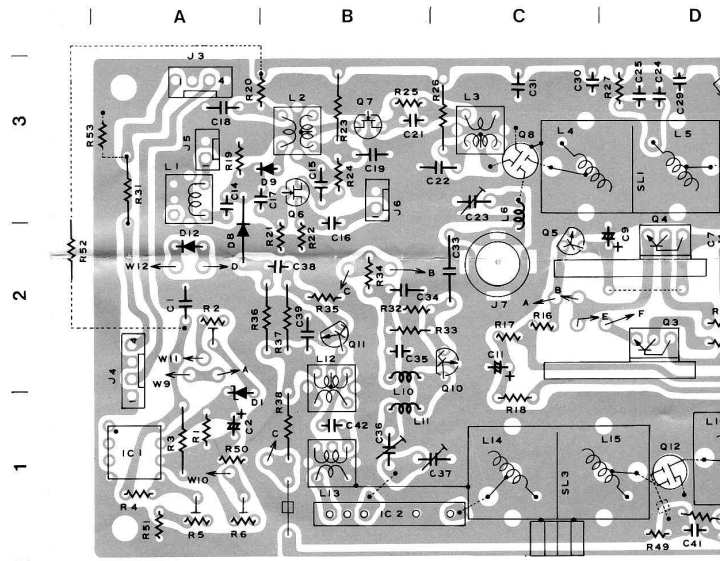

PLL/2nd MIXER UNIT

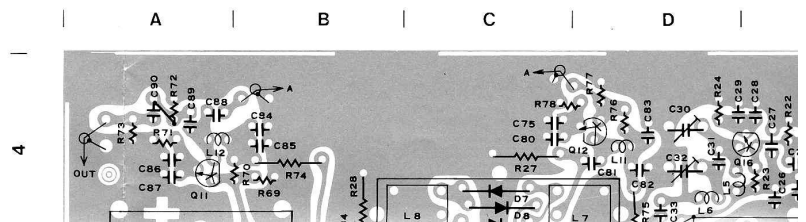

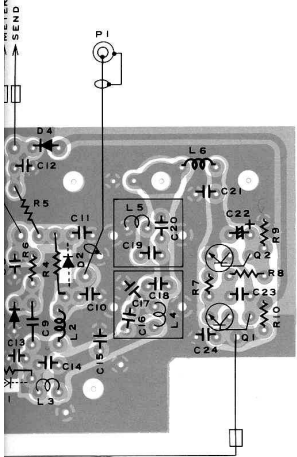

PI BOARD

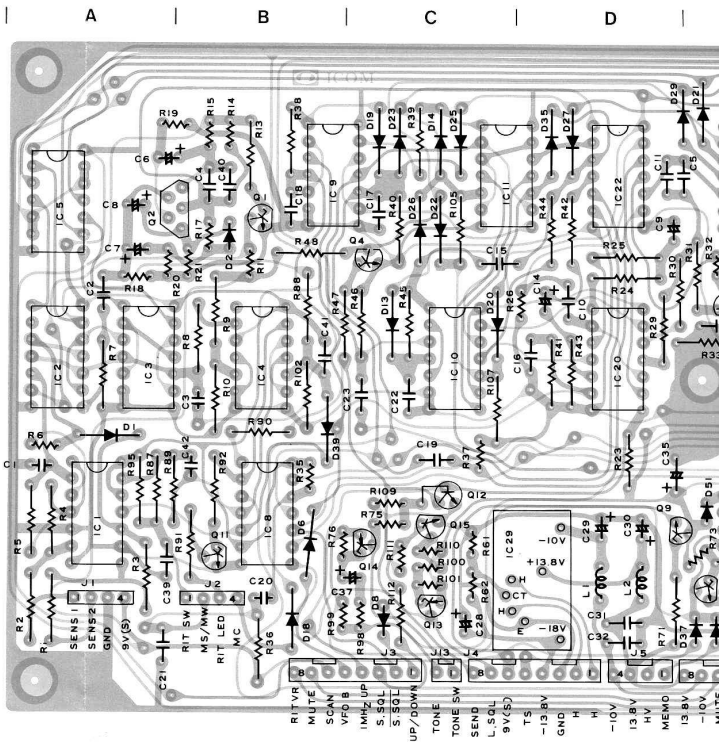
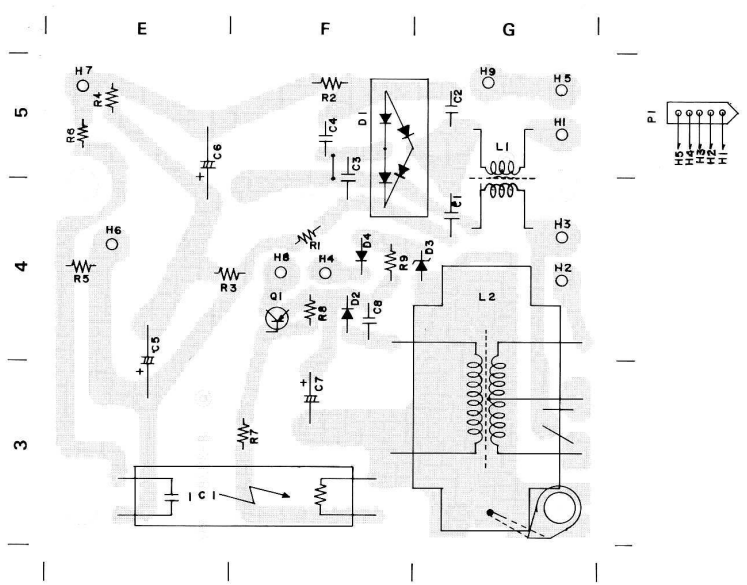

4
3
2
1

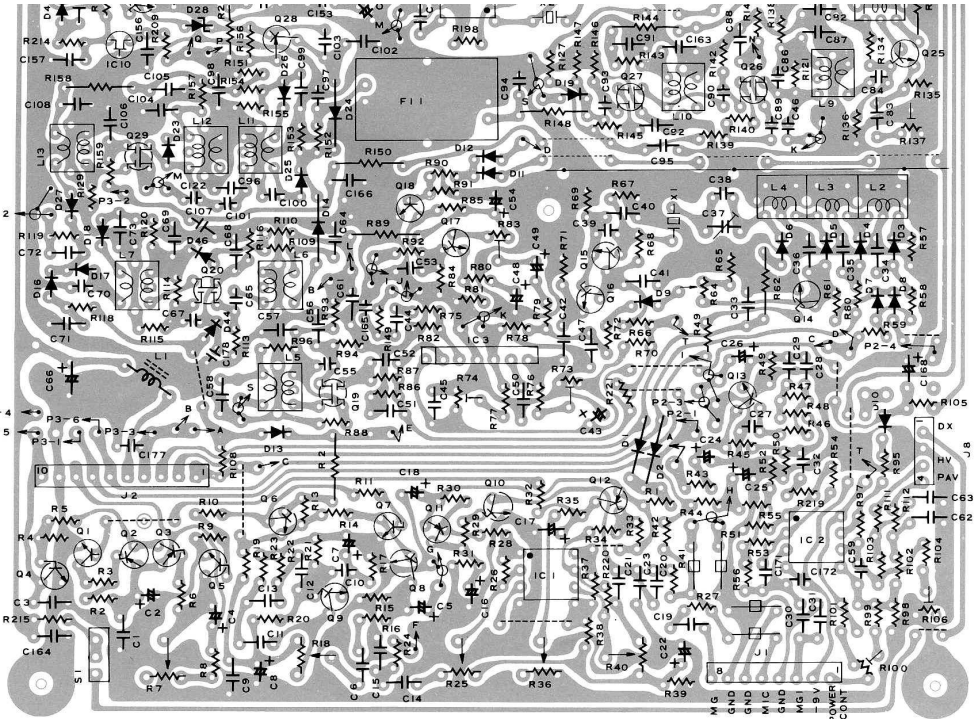

VCO UNIT

A B

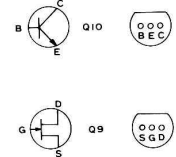
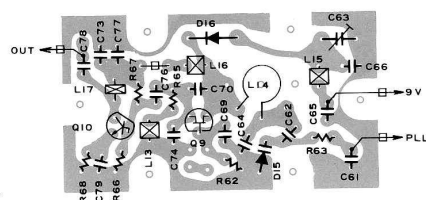

POWER AMPLIFIER UNIT

A B C D E

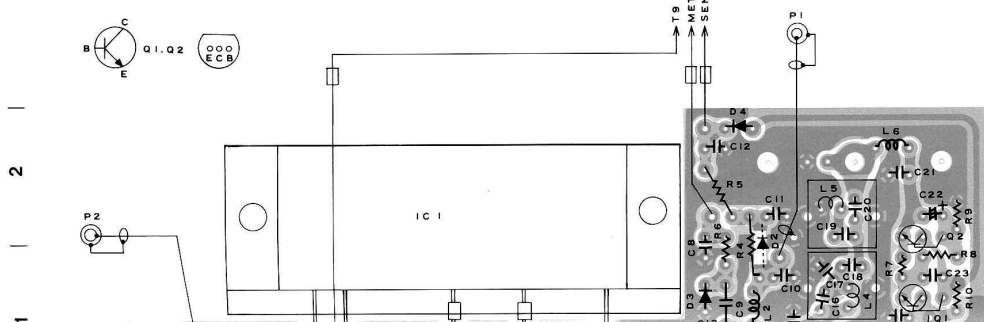

POWER AMPLIFIER UNIT

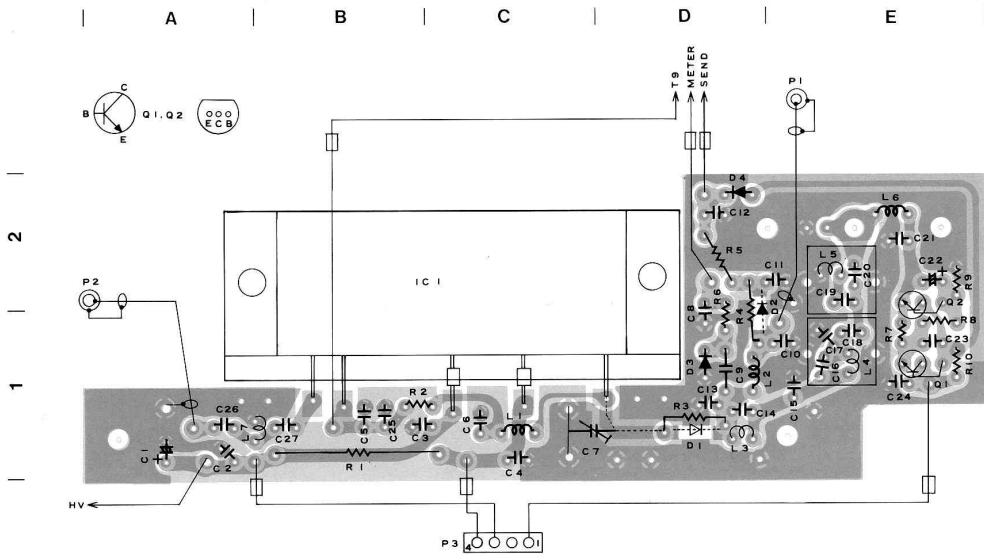

POWER SUPPLY UNIT

SWITCHING REGULATOR BOARD

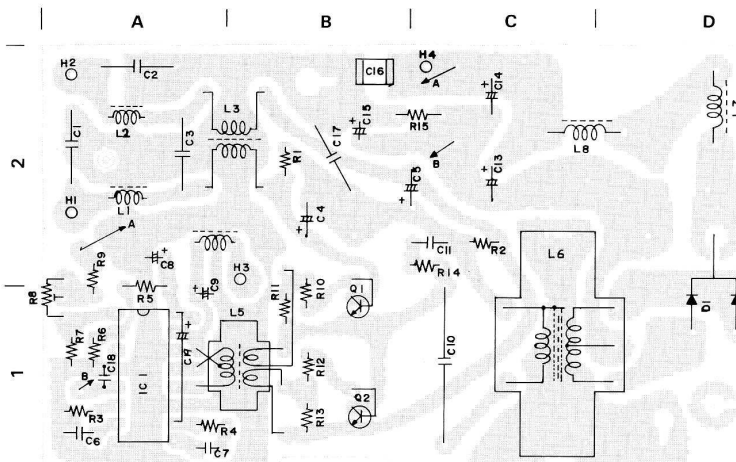

PI BOARD

