



## ADVANCED MANUAL

VHF/UHF TRANSCEIVER  
**ID-52A**  
**ID-52E**

This manual describes instructions for advanced features and instructions.  
See the BASIC MANUAL that come with the transceiver for precautions and basic operations.

- 1 ATTACHING ACCESSORIES
- 2 USING a microSD CARD
- 3 BATTERY CHARGING
- 4 FM RADIO OPERATION
- 5 D-STAR OPERATION (ADVANCED)
- 6 GPS OPERATION (ADVANCED)
- 7 VOICE TX FUNCTION
- 8 RECORDER FUNCTION
- 9 MEMORY OPERATION
- 10 SCAN OPERATION
- 11 REPEATER AND DUPLEX OPERATIONS
- 12 SET MODE
- 13 Bluetooth® OPERATION
- 14 SHARE PICTURES FUNCTION
- 15 OTHER FUNCTIONS
- 16 UPDATING THE FIRMWARE
- 17 OPTIONS

---

## INTRODUCTION

Thank you for choosing this Icom product. This product is designed and built with Icom's state of the art technology and craftsmanship. With proper care, this product should provide you with years of trouble-free operation.

This product combines traditional analog technologies with Digital Smart Technologies for Amateur Radio (D-STAR), for a balanced package.

---

## ABOUT THE CONSTRUCTION OF THE MANUAL

(As of November 2021)

You can use the following manuals to understand and operate this transceiver.

① If necessary, you can download a glossary of HAM radio terms from the Icom website.

**TIP:** You can download each manual and guide from the Icom website:

<https://www.icomjapan.com/support/>

Enter "ID-52A" or "ID-52E" into the Search box on the site.

### Basic manual (Comes with the transceiver)

Instructions for the basic operations and precautions. **D-STAR GUIDE** that explains registering your call sign to a gateway repeater and D-STAR's basic operations is also included.

### Advanced manual (This manual)

- Attaching accessories
- Using a microSD card
- Battery charging
- FM Radio operation
- D-STAR operation (ADVANCED)
- GPS operation (ADVANCED)
- VOICE TX function
- Recorder function
- Memory operation
- Scan operation
- Repeater and duplex operations
- SET mode
- Bluetooth® operation
- Share Pictures function
- Other functions
- Updating the firmware
- Options

### CI-V Reference Guide (PDF type)

Describes the control commands used in remote control operation (serial communication using CI-V).

### About the DV Gateway function (PDF type)

Instructions for the system requirements or operations to use the DV Gateway function.

### Updating the repeater list (PDF type)

Instructions for the steps to update the repeater list.

### Using the GPS Logger function (PDF type)

Instructions for operating the GPS Logger function that saves location data from a GPS receiver onto a microSD card as a log.

---

## TRADEMARKS

Icom, Icom Inc. and the Icom logo are registered trademarks of Icom Incorporated (Japan) in Japan, the United States, the United Kingdom, Germany, France, Spain, Russia, Australia, New Zealand, and/or other countries.

The Bluetooth word mark and logos are registered trademarks owned by the Bluetooth SIG, Inc. and any use of such marks by Icom Inc. is under license. Other trademarks and trade names are those of their respective owners.

Adobe, Acrobat, and Reader are either registered trademarks or trademarks of Adobe Systems Incorporated in the United States and/or other countries.

APRS® is a registered trademark of Mr. Bob Bruninga in the U.S.A. and other countries.

Microsoft and Windows are trademarks of the Microsoft group of companies.

Google, the Google Logo, Google Play, the Google Play logo, Android, and the Android logo are trademarks of Google, LLC.

IOS is a trademark or registered trademark of Cisco in the U.S. and other countries and is used under license.

iPadOS is a trademark of Apple Inc.

App Store is a service mark of Apple Inc.

All other products or brands are registered trademarks or trademarks of their respective holders.

# FUNCTIONS AND FEATURES OF ADOBE® ACROBAT® READER®

The following functions and features can be used with Adobe Acrobat Reader.

• **Keyword search**

Click “Find” (Ctrl+F) or “Advanced Search” (Shift+Ctrl+F) in the Edit menu to open the search screen. This is convenient when searching for a particular word or phrase in this manual.

① The menu screen may differ, depending on the Adobe Acrobat Reader version.

Click to open the find or search screen or advanced search screen.

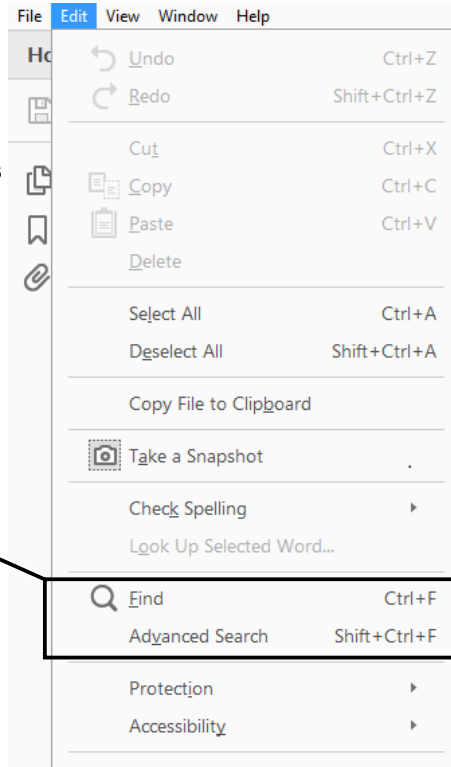

• **Find screen**

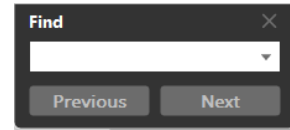

• **Advanced search screen**

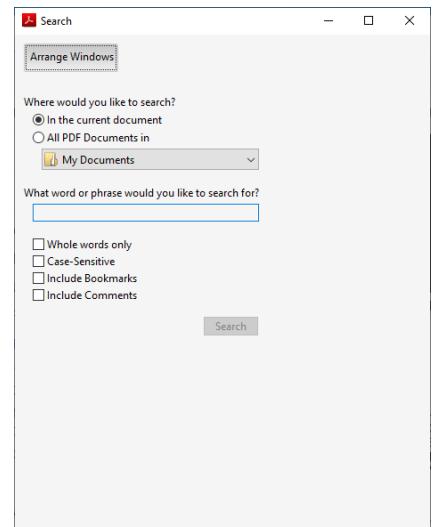

• **Printing out the desired pages.**

Click “Find (Ctrl+F)” or “Advanced Search (Shift+Ctrl+F)” in the Edit menu to open the search screen.

This is convenient when searching for a particular word or phrase in this manual.

① The menu screen may differ, depending on the Adobe Acrobat Reader version.

① Select the “A4” size to print out the page in the original manual size.

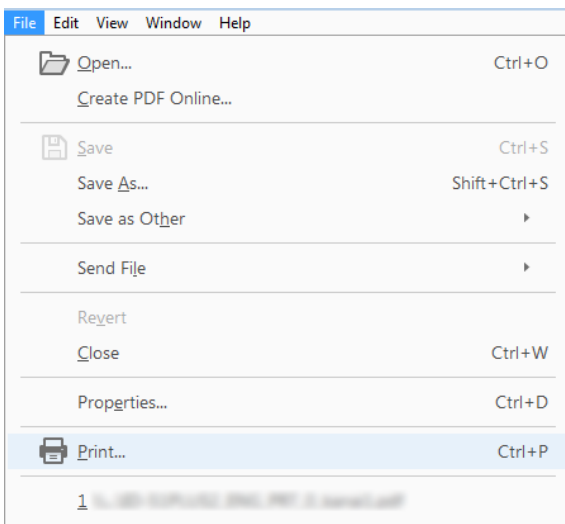

• **Read Out Loud feature.**

The Read Out Loud feature reads aloud the text in this PDF.

Refer to the Adobe Acrobat Reader Help for the details.

(This feature may not be usable, depending on your PC environment, including the operating system.)

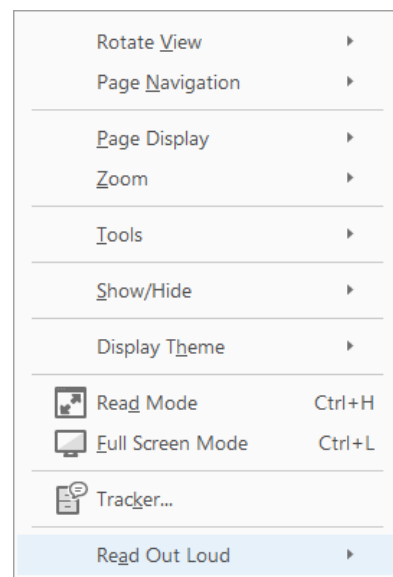

① The screen may differ, depending on the Adobe Acrobat Reader version.

ENTERING AND EDITING TEXT

Controls used for text entry

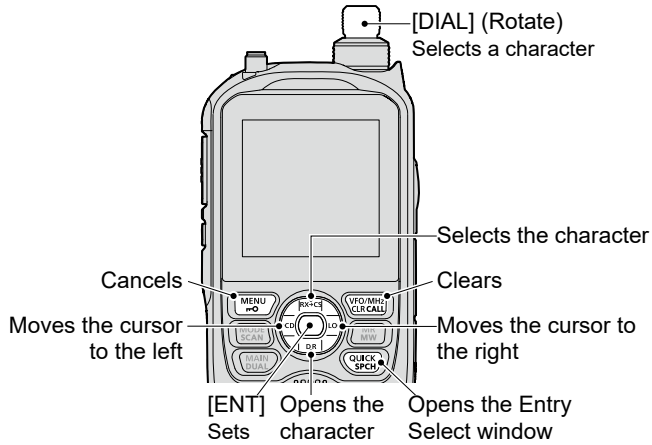

- To insert a text, move the cursor to a place to enter, and then rotate [DIAL] or push D-pad(↓↑).
- To clear a character, push [CLR].
- To consecutively clear characters, continuously hold down [CLR].

To change the character type

1. When not selecting text, or an entered text is selected, push [QUICK].
2. Rotate [DIAL] to select the character type, and then push [ENT].



| Character type | Selectable characters and symbols  | Character conversion |
|----------------|--|----------------------|
| ABC            | A to Z, 0 to 9, (space)  | A/a                  |
| abc            | a to z, 0 to 9, (space)  | A/a                  |
| 123            | 0 to 9, (space)  | -                    |
| !\"#           | ! \" \$ % & ' ( ) * + , - . / : ; < = > ? @ [ \\ ] ^ _ ` {   } ~ (space) | -                    |

**TIP:** When the character type is “ABC” or “abc,” and while entering a character, push [QUICK] to select upper case or lower case letters.

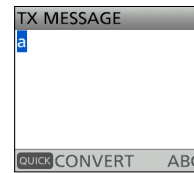

▲ ▼ Push [QUICK]

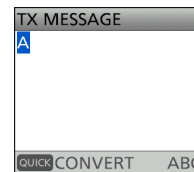

INTRODUCTION

USABLE CHARACTERS

The usable characters and symbols and the maximum characters differ, depending on the item. See the following list for details.

① The usable characters and symbols for each character type are described at the bottom of the page.

| Category        | Item                  | Character type             | Maximum characters | Information  |
|-----------------|-----------------------|----------------------------|--------------------|--|
| FM Radio Memory | Group Name            | [ABC] [abc] [123] [!"#]    | 16                 | –  |
|                 | Name                  | [ABC] [abc] [123] [!"#]    | 16                 | –  |
| Memory CH       | Group name            | [ABC] [abc] [123] [!"#]    | 16                 | –  |
|                 | Name                  | [ABC] [abc] [123] [!"#]    | 16                 | –  |
| Call CH         | Name                  | [ABC] [abc] [123] [!"#]    | 16                 |  |
| Your Call Sign  | Name                  | [ABC] [abc] [123] [!"#]    | 16                 | –  |
|                 | Call Sign             | A to Z, 0 to 9, /, (space) | 8                  | –  |
| Repeater List   | Group Name            | [ABC] [abc] [123] [!"#]    | 16                 | –  |
|                 | Name                  | [ABC] [abc] [123] [!"#]    | 16                 | –  |
|                 | Sub Name              | [ABC] [abc] [123] [!"#]    | 8                  | –  |
|                 | Call Sign             | A to Z, 0 to 9, /, (space) | 8                  | –  |
|                 | GW Call Sign          | A to Z, 0 to 9, /, (space) | 8                  | –  |
| GPS TX Mode     | Unproto Address       | [ABC] [abc] [123] [!"#]    | 56                 | Normally 12 characters (API52,DSTAR*)  |
|                 | Comment               | [ABC] [abc] [123] [!"#]    | 43                 | The number of characters you can enter differs, depending on the data extension and altitude settings. |
|                 | Object Name/Item name | [ABC] [abc] [123] [!"#]    | 9                  | –  |
|                 | GPS Message           | [ABC] [abc] [123] [!"#]    | 20                 | –  |
| GPS Memory      | Group Name            | [ABC] [abc] [123] [!"#]    | 16                 | –  |
|                 | Name                  | [ABC] [abc] [123] [!"#]    | 16                 | –  |
| P-Scan Edge     | Name                  | [ABC] [abc] [123] [!"#]    | 16                 | –  |
| Program Link    | Program Link name     | [ABC] [abc] [123] [!"#]    | 16                 | –  |
| CS screen       | UR                    | A to Z, 0 to 9, /, (space) | 8                  | –  |
|                 | R1                    | A to Z, 0 to 9, /, (space) | 8                  | –  |
|                 | R2                    | A to Z, 0 to 9, /, (space) | 8                  | –  |
| My Call Sign    | Call Sign             | A to Z, 0 to 9, /, (space) | 12 (+1)            | Includes “/” between the Call sign and Memo field.   |
| My Station      | TX Message            | [ABC] [abc] [123] [!"#]    | 20                 | –  |
| DTMF Memory     | DTMF code             | 0 to 9, A, B, C, D, *, #   | 24                 | –  |
| SD Card         | Save Setting          | [ABC] [abc] [123] [!"#]    | 23                 | Illegal characters: / : ; * < >  |
|                 | Export                | [ABC] [abc] [123] [!"#]    | 23                 | Illegal characters: / : ; * < >  |
| Bluetooth       | Device Name           | [ABC] [abc] [123] [!"#]    | 9                  | Excluding “ICOM BT”  |
| DR screen       | Direct Input (UR)     | A to Z, 0 to 9, /, (space) | 8                  | –  |
|                 | Direct Input (RPT)    | A to Z, 0 to 9, /, (space) | 8                  | –  |

[ABC]: A to Z, 0 to 9, (space)

[abc]: a to z, 0 to 9, (space)

[123]: 0 to 9, (space)

[!"#]: ! " # \$ % & ' ( ) \* + , - . / : ; < = > ? @ [ \ ] ^ \_ ` { | } ~ (space)

# HOW TO ENTER TEXT

**Example:** Entering “Calling” as a Memory name.

[MENU] > MEMORY > **Memory CH**

1. Push [MENU].
2. Select “MEMORY” on the second page of the MENU screen.
3. Select “Memory CH.”
4. Select a channel group where the memory channel you want to edit is listed.
5. Rotate [DIAL] to select a Memory channel.

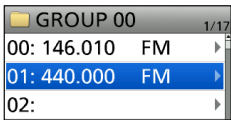
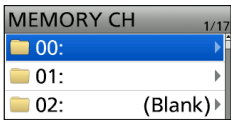

6. Push [QUICK].
7. Select “Edit.”

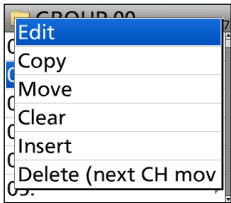

- The Edit screen is displayed.

8. Select “NAME.”

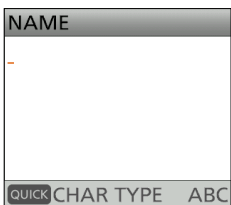
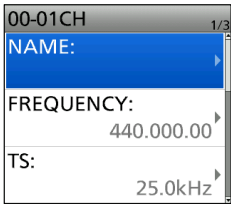

9. Push [QUICK].
10. Select the character type.

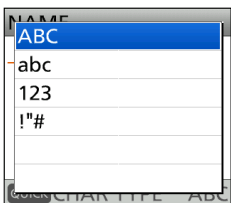

① To enter symbols, select “!"#.”

11. Rotate [DIAL] to select a character, then push [ENT].

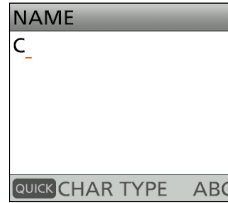

**Information**

- To move the cursor forward, push D-pad(→).
- To move the cursor backward, push D-pad(←).
- To insert a character, move the cursor to a place to enter, then rotate [DIAL].
- To clear a character, push [CLR].
- To consecutively clear characters, continuously hold down [CLR].
- When the character type is “ABC” or “abc,” and while entering a character, push [QUICK] to select upper case or lower case letters.

12. Repeat steps 9 ~ 11 to enter a name, and push [ENT].

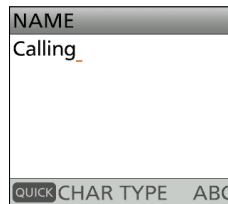

- Returns to the Edit screen, and the entered name is displayed.

13. Select “<<OverWrite>>.”

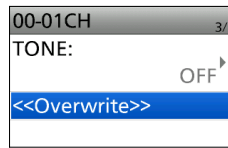

- A confirmation dialog is displayed.

14. Select “YES.”

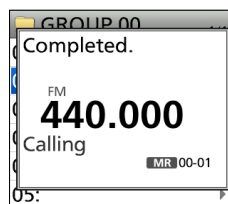
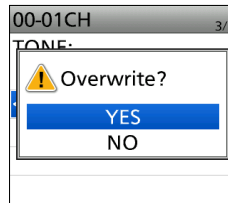

- The Memory name is overwritten.

# Section 1 ATTACHING ACCESSORIES

---

|  |     |
|--|-----|
| Attaching the antenna.....                 | 1-2 |
| Attaching and detaching the battery.....   | 1-2 |
| Attaching and detaching the belt clip..... | 1-3 |
| Attaching the hand strap.....              | 1-3 |

# 1 ATTACHING ACCESSORIES

## Attaching the antenna

Insert the antenna into the base of the SMA antenna connector and tighten the antenna.

**TIP:** Third-party high gain antennas may increase transceiver performance. The optional AD-92SMA antenna connector adapter enables you to use antennas with a BNC connector. (p. 17-2)

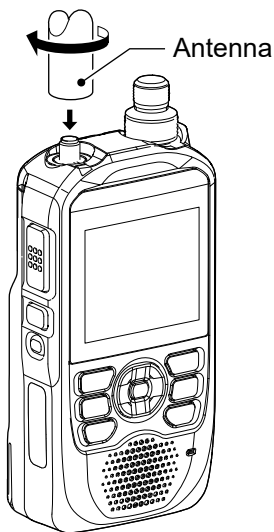

## Attaching and detaching the battery

To attach or detach the battery pack or battery case, see the illustrations below. See page 3-8 for battery case details.

- ① When attaching the battery case, slide it, and press firmly until it is fixed with both latches.
- ② When detaching the battery case, turn OFF the transceiver.

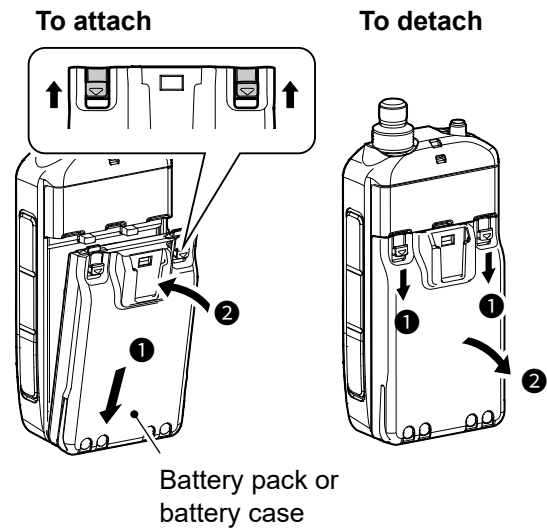

### NOTE:

- Even when the transceiver is turned OFF, a small current still flows in the transceiver. When not using the transceiver for a long time, remove the battery pack or case to prevent the batteries from becoming exhausted.
- The battery protection function automatically reduces power to Low1 power (0.5 W) when the temperature is around 0°C (32°F) or below. In addition, High, Mid, and Low2 power selections are disabled.

# 1 ATTACHING ACCESSORIES

## Attaching and detaching the belt clip

To attach or detach the belt clip, first remove the battery pack or case, if it is attached. (p. 1-2) See the illustration below.

To attach the belt clip, slide the belt clip in the direction of the arrow until the belt clip locks in place, and makes a 'click' sound.

To detach the belt clip, lift the tab up (1) and slide the belt clip in the direction of the arrow (2).

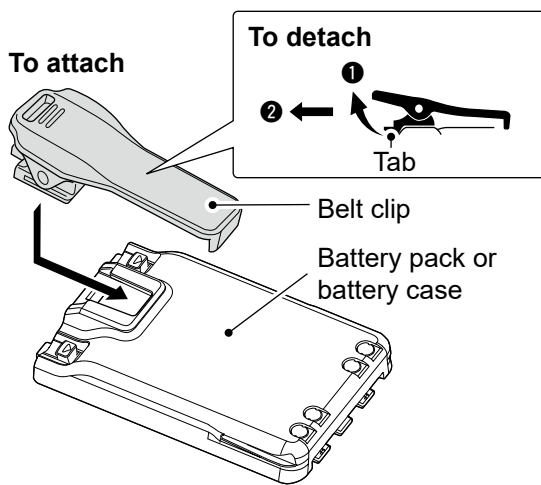

## Attaching the hand strap

Slide the hand strap through the loop on the top of the rear panel, as illustrated below.

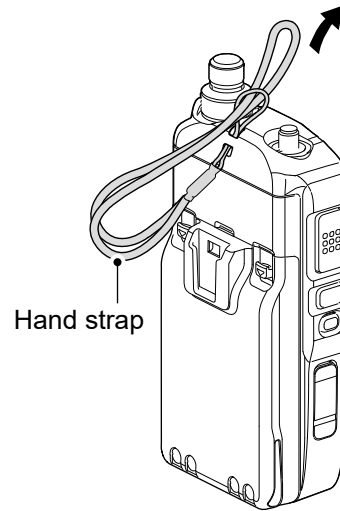

**⚠ WARNING! NEVER** swing the transceiver by holding the hand strap. This could cause injury to yourself or others.

## Section 2 USING a microSD CARD

---

**NOTE:** See the Basic manual Section 6 for details on how to insert or remove a microSD card and precautions.

|  |      |
|--|------|
| About data saved on a microSD card.....                              | 2-2  |
| Saving settings onto a microSD card .....                            | 2-2  |
| ◇ Saving as a new file .....   | 2-2  |
| Saving with a different file name.....                               | 2-3  |
| Loading the saved files on the microSD card.....                     | 2-4  |
| Backing up data saved on the microSD card onto a PC .....            | 2-5  |
| ◇ About the microSD card's folder.....                               | 2-5  |
| ◇ Making a backup file on your PC.....                               | 2-6  |
| Importing or exporting a CSV format file .....                       | 2-7  |
| ◇ Importing .....  | 2-7  |
| ◇ Exporting .....  | 2-8  |
| About the SD Card mode .....   | 2-9  |
| Check the free space and the recording time on the microSD card..... | 2-10 |

### About data saved on a microSD card

The following data can be saved onto the card:

- The transceiver's settings
- Communication/receive log and contents
- Automatic answering voice audio in the DV mode
- Voice audio for the Voice TX function
- Voice recorder
- Captured screens
- Memory channel contents
- FM Radio memory
- Your (UR) call sign memory
- Repeater List
- GPS memory
- Position data from the GPS receiver
- Pictures for the Share Pictures function
- Transmitted and received log of Share Picture
- Pictures for the Opening Picture setting

### Saving settings onto a microSD card

The Memory channels, settings on the MENU screen, and the Repeater List can be saved on a microSD card.

Saving data on the card enables you to easily restore the transceiver to its previous configuration, even if you perform an All Reset.

You can save settings data as a new file, or you can overwrite a current file.

#### ◇ Saving as a new file

[MENU] > SET > SD Card > **Save Setting**

1. Push [MENU].
2. Select "SD Card" in the "SET" menu.

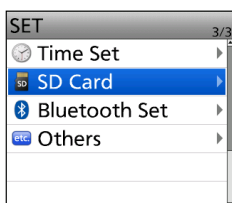

3. Select "Save Setting."

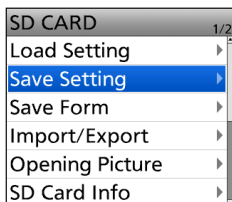

4. Select "<<New File>>."

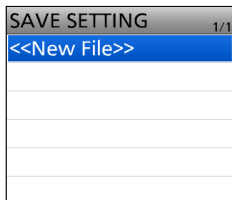

- The file is named in the following format:  
Setyyyyymmdd\_xx  
(yyyy: Year, mm: month, dd: day, xx: file number).

① To change the file name, see page 2-3.

5. Push [ENT].



- The confirmation screen is displayed.

6. Select "YES."

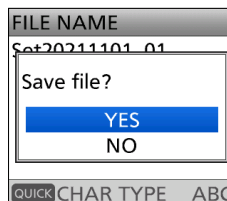

- While saving, a progress bar is displayed. When saving is completed, the SD CARD screen is displayed.

① To exit the MENU screen, push [MENU].

#### Overwriting a current file:

To overwrite data in a current file, select the file you want to overwrite in step 4 to the left.

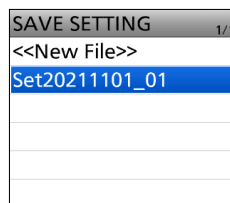

#### TIP:

- Data is saved in the "icf" file format. You can copy the icf data on a PC and edit it using the CS-52 PROGRAMMING SOFTWARE.
- If "Save Form" is set to the earlier firmware version, the confirmation window is displayed after step 4. To save the data in the earlier firmware version, select "YES."

### Saving with a different file name

[MENU] > SET > SD Card > **Save Setting**

1. Push [MENU].
2. Select "SD Card" in the "SET" menu.

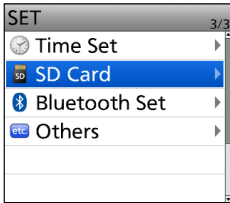

3. Select "Save Setting."

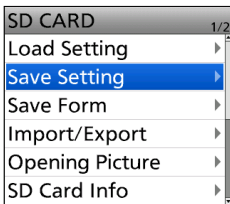

4. Select "<<New File>>."

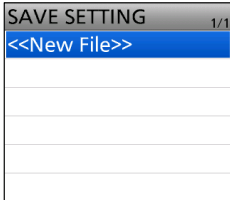

5. Hold down [CLR] to delete the characters.

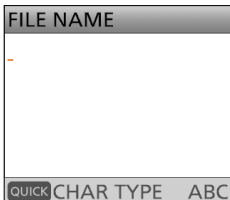

6. Enter a file name, and then push [ENT].

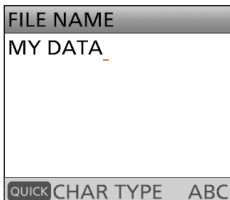

① See page iii on how to enter characters.

7. Select "YES."

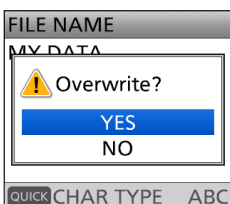

- While saving, a progress bar is displayed. When saving is completed, the SD CARD screen is displayed.
- ① To exit the MENU screen, push [MENU].

### Loading the saved files on the microSD card

The saved Memory channels, settings on the MENU screen, and Repeater List can be copied to the transceiver.

This makes it easy to copy Memory channels or the Repeater List, to another ID-52A/ID-52E and operate with the same data.

**NOTE:** Saving the current data is recommended before loading other data into the transceiver.

**Example:** Loading all the data in the "Set20211101\_01" file

[MENU] > SET > SD Card > Load Setting

1. Push [MENU].
2. Select "SD Card" in the "SET" menu.

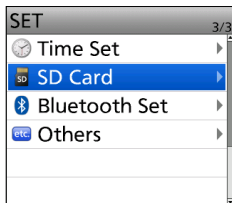

3. Select "Load Setting."

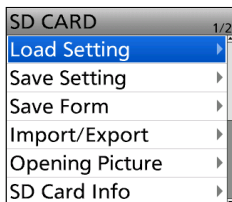

4. Select a data file to load into the transceiver.

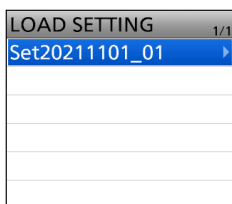

5. Select the loading content.

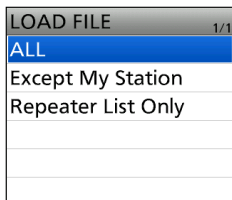

- **ALL:** Loads all Memory channels, settings on the MENU screen, and the Repeater List into the transceiver.
- **Except My Station:** Loads all Memory channels, setting on the MENU screen except MY call signs, and the Repeater List into the transceiver.
- **Repeater List Only:** Loads only the Repeater List into the transceiver.

6. Select "YES" or "NO."

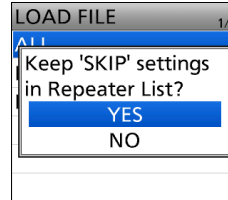

- **YES:** The skip settings of the Repeater List are retained.
- **NO:** The skip settings of the Repeater List are cleared.

7. Select "YES."

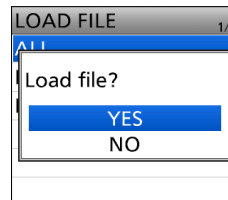

- Starts checking and loading the data file.
- After loading, "COMPLETED!" is displayed.

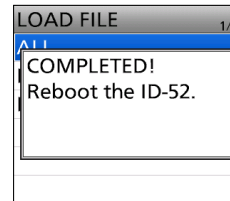

8. Restart the transceiver to operate with the new setting.

### Backing up data saved on the microSD card onto a PC

A backup file enables easy restoration, even if the data on the microSD card is accidentally deleted.

#### ◆ About the microSD card's folder

The folder in the microSD card contains the following:

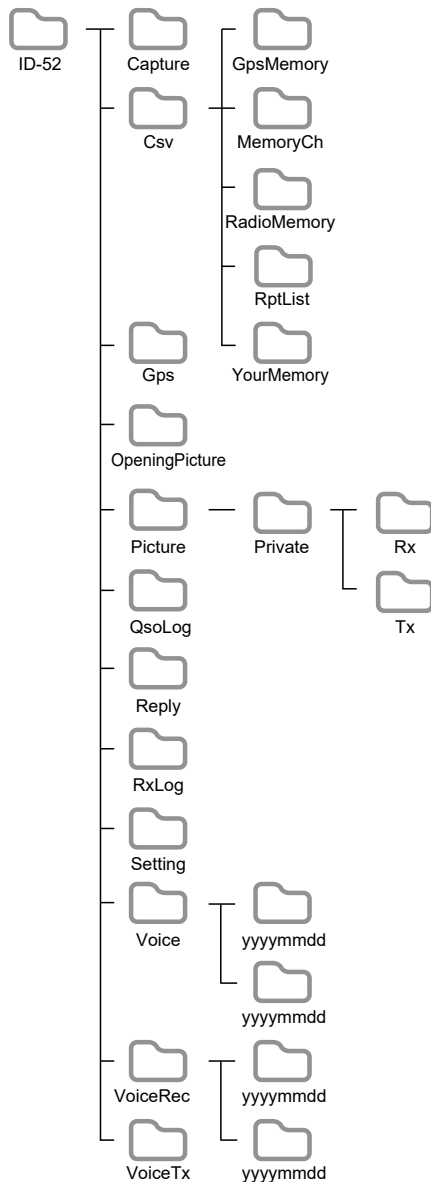

- **ID-52 folder**  
The folders created in the transceiver are contained in this folder.
- **Capture folder**  
The captured screen data in the “png” or “bmp” format.
- **Csv folder**  
The Repeater List, Your (UR) call sign memory, GPS Memory folders, and so on.

- **GpsMemory folder**  
The GPS Memory in the “csv” format.
- **MemoryCh folder**  
The Memory channel contents in the “csv” format.
- **RadioMemory folder**  
The FM Radio memory contents in the “csv” format.
- **RptList folder**  
The Repeater List in the “csv” format.
- **YourMemory folder**  
The Your (UR) call sign memory in the “csv” format.
- **Gps folder**  
The GPS logging data in the “log” format.
- **OpeningPicture folder**  
The pictures in the “bmp” format that are used for the Opening Picture setting.
- **Picture folder**  
The pictures in the “jpg” format that are used with the Share Pictures function.
- **Private folder**  
The RX Picture History and TX Picture History.
- **Rx folder**  
The RX Picture History in the “dat” format.  
① The RX Picture History contents are not displayed on the PC.
- **Tx folder**  
The TX Picture History in the “dat” format.  
① The TX Picture History contents are not displayed on the PC.
- **QsoLog folder**  
The QSO log data in the “csv” format.
- **Reply folder**  
The automatic reply data in the “wav” format.
- **RxLog folder**  
The RX record log data in the “csv” format.
- **Setting folder**  
The transceiver's setting data in the “icf” format.
- **Voice folder**  
The recorded QSO audio date folders.
- **VoiceRec folder**  
The recorded Voice recorder audio date folders.
- **yyyyymmdd folder**  
The recorded QSO audio data and the recorded Voice recorder audio data is saved in the “wav” format.
- **VoiceTx folder**  
The recorded voice audio data for the Voice TX function in the “wav” format.

## 2 USING a microSD CARD

### Backing up data saved on the microSD card onto a PC

#### ◇ Making a backup file on your PC

Windows® 10 is used for these instructions.

1. Insert the microSD card into the microSD card drive or a memory card reader on your PC.
2. Click the “Open folder to view files” option to access the card.

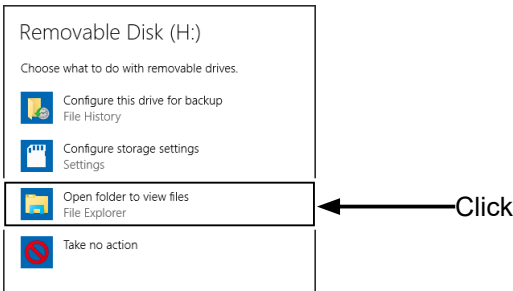

- 'ID-52' folder is displayed.
3. Right-click “Removable disk.”
  4. Click “Copy.”

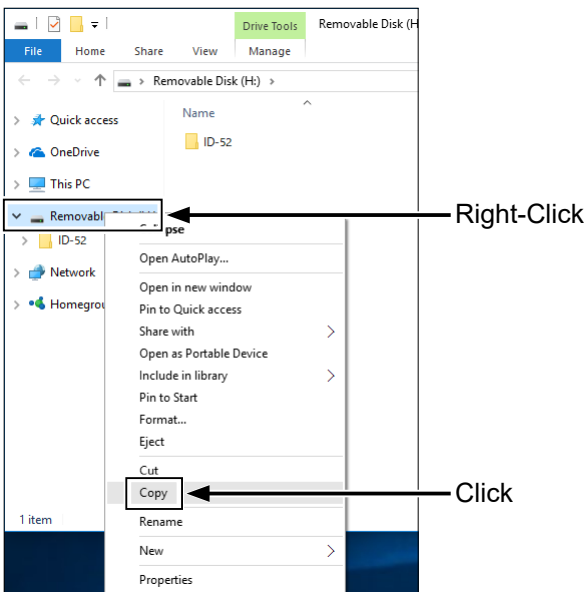

5. Open a folder to copy a backup file, then right-click, and then click “Paste.”
  - Copies the card data onto your PC.(**Example:** Copying into the “Backup” folder on the C drive)

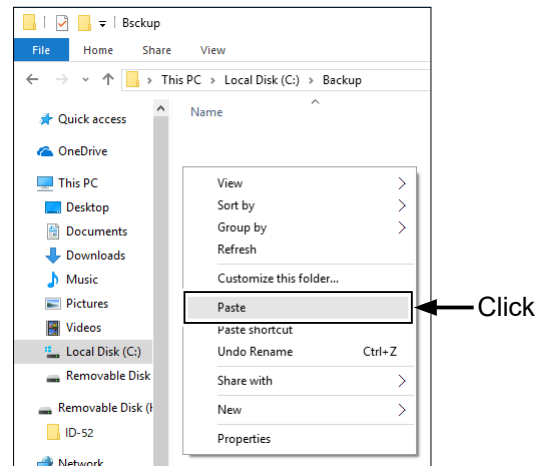

6. To remove the card, click the remove media icon (“”) in the screenshot shown below) in the taskbar. Then, click “Eject Removable Disk.”

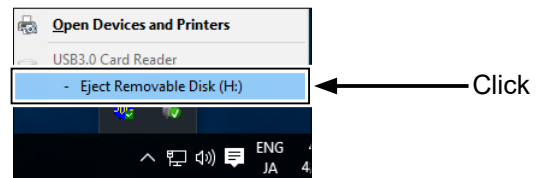

7. When “Safe To Remove Hardware” is displayed, remove the card.

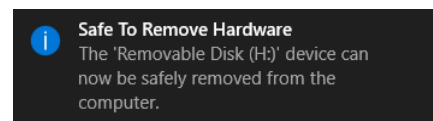

**TIP:** When “USB Connect” is set to “SD Card Mode,” and the transceiver is connected to the PC through a USB data cable, you can directly access the microSD card that is set in the transceiver from the PC. ([MENU] > SET > Function > **USB Connect**)

### Importing or exporting a CSV format file

Read this section before importing or exporting a Comma Separated Values (CSV) format file from the microSD card.

You can import or export the following data:

- Memory CH
- FM Radio Memory
- Your Call Sign
- Repeater List
- GPS Memory

#### ◇ Importing

##### NOTE:

- Before importing, make a backup file of all the transceiver's data to the card in case of data loss.
- The transceiver cannot display files that have a file name 24 or more characters. If necessary, rename them using 23 characters or less. When exporting CSV format files using the CS-52, **BE SURE** the names are 23 characters or less.

**Example:** Importing the Your Call sign memory.

[MENU] > SET > SD Card > Import/Export > Import

1. Push [MENU].
2. Select "SD Card" in the "SET" menu.

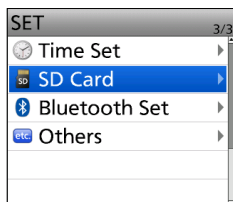

3. Select "Import/Export."

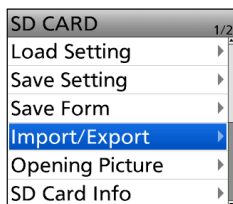

4. Select "Import."

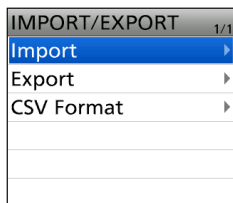

5. Select "Your Call Sign."

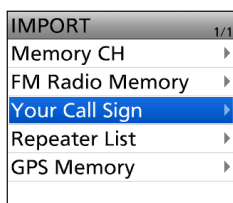

6. Select the CSV file to import.

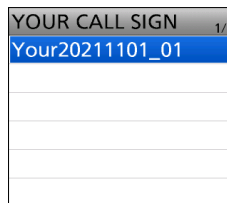

- The confirmation dialog is displayed.

**TIP:** When importing a Repeater List, "Keep 'SKIP' settings in Repeater List?" is displayed. See step 6 on page 2-4 for details.

7. Select "YES."

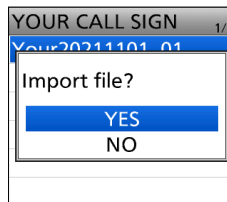

- Starts importing.
- After importing ends, "COMPLETED!" is displayed.

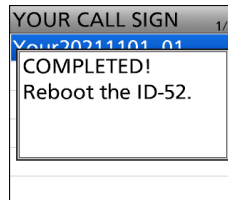

8. To complete importing, restart the transceiver.

## 2 USING a microSD CARD

### Importing or exporting a CSV format file

#### ◇ Exporting

##### Saving as a new file:

**Example:** Exporting the Your Call sign memory.

[MENU] > SET > SD Card > Import/Export > **Export**

1. Push [MENU].
2. Select “SD Card” in the “SET” menu.

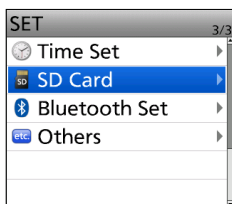

3. Select “Import/Export.”

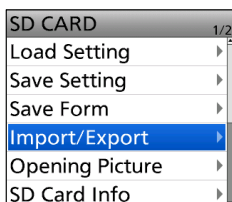

4. Select “Export.”

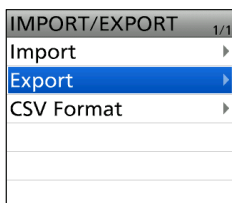

5. Select “Your Call Sign.”

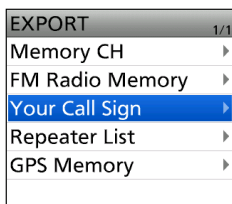

6. Select “<<New File>>.”

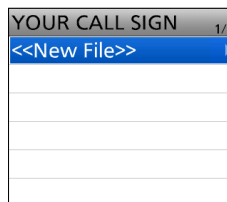

- Displays the FILE NAME screen.

- ① The file is named in the following format:

Your\*yyyymmdd\_xx

(yyyy: Year, mm: month, dd: day, xx: file number).

\* When you select the other items, each file is named as shown below.

Memory CH: “Mch”

FM Radio Memory: “Radio”

Repeater List: “Rpt”

GPS Memory: “Gps”

- ① See page iii on how to enter characters.

7. Push [ENT].

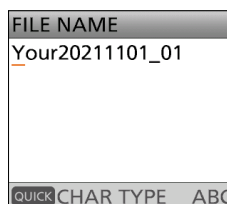

- The confirmation dialog is displayed.

8. Select “YES.”

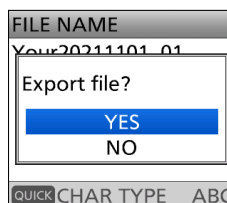

- Exports the setting data.

- ① To exit the MENU screen, push [MENU].

#### Overwriting the current file:

When you overwrite data in a current file, select the file you want to overwrite in step 6 to the left.

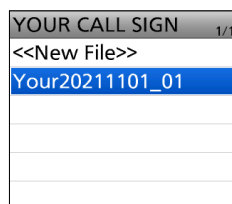

### About the SD Card mode

When “USB connect” is set to “SD Card Mode,” and the transceiver is connected to the PC through a USB data cable, you can transfer the files between the microSD card set in the transceiver and a PC. You can back up the setting data and recording data saved on the microSD card to a PC, and save the image data for the Share Pictures function and the firmware data to the microSD card without inserting or removing it.

#### [MENU] > SET > Function > **USB Connect**

1. Connect the transceiver to a PC using a USB cable.
2. Push [MENU].
3. Select “Function” in the “SET” menu.
4. Select “USB Connect.”

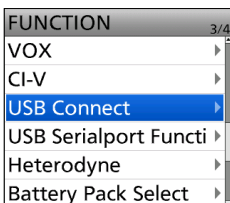

5. Select “SD Card Mode.”

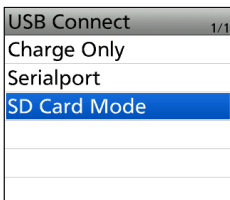

- The confirmation dialog is displayed.

6. Select “Yes.”

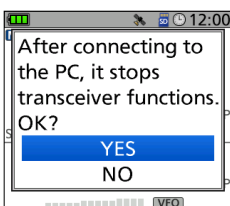

**NOTE:** Before connecting the transceiver in the SD Card mode to a PC with a USB cable, a microSD card must be inserted.

- ① If the microSD card is not inserted, insert it with the transceiver turned OFF, and then reconnect the USB cable.

**TIP:** In the SD Card mode, the transceiver works not as a transceiver but as a data storage device. It temporarily stops some functions as follows:

- Stops recording
- Pauses the GPS Logger function and the RX History Log function
- Disconnects a Bluetooth device
- Disables the Auto Power OFF function

#### To exit the SD Card mode

- ① This instruction manual is based on Windows 10.

1. Click “” in the task tray.
2. Click “Eject Device.”
3. After “Safe to Remove Hardware” is displayed, remove the USB cable from the PC.

## 2 USING a microSD CARD

### Check the free space and the recording time on the microSD card

[MENU] > SET > SD Card > **SD Card Info**

1. Push [MENU].
2. Select “SD Card” in the “SET” menu.
3. Select “SD Card Info.”

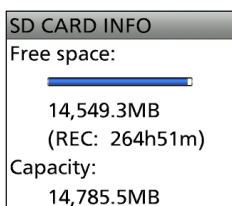
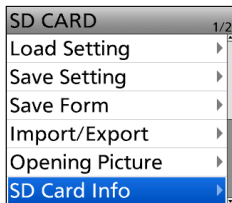

- The free space and the recording time on the microSD card are displayed.
- ① To exit the MENU screen, push [MENU].

|   |     |
|---|-----|
| Battery information .....                                     | 3-2 |
| ◇ Battery life .....  | 3-2 |
| ◇ Battery icon .....  | 3-2 |
| Charging information .....                                    | 3-3 |
| ◇ Charging through the [DC IN] jack .....                     | 3-3 |
| ◇ Charging with a USB cable .....                             | 3-4 |
| Charging with the BC-202IP2 optional rapid charger .....      | 3-5 |
| Charging with the BC-202IP3L optional rapid charger .....     | 3-6 |
| Connecting BC-202IP3L together.....                           | 3-7 |
| External DC power operation .....                             | 3-7 |
| About the optional battery case .....                         | 3-8 |
| ◇ Battery life .....  | 3-8 |
| ◇ About the battery replacement .....                         | 3-8 |
| Specifications for the battery charger and battery packs..... | 3-9 |
| ◇ BP-271 Li-ion BATTERY PACK (optional) .....                 | 3-9 |
| ◇ BP-272 Li-ion BATTERY PACK (supplied) .....                 | 3-9 |
| ◇ BP-307 Li-ion BATTERY PACK (optional) .....                 | 3-9 |
| ◇ BC-202IP2 RAPID CHARGER (optional).....                     | 3-9 |
| ◇ BC-202IP3L RAPID CHARGER (optional).....                    | 3-9 |

## Battery information

### ◇ Battery life

The approximate battery life (operating time) as shown below is calculated under the following assumptions:

- Power save setting: Auto (Short)
- Duty cycle: TX : RX : Standby = 1 : 1 : 8  
(based on operating style)

#### The approximate battery life:

| Battery pack | FM mode    |
|--------------|------------|
| BP-271       | 4.25 hours |
| BP-272       | 7.25 hours |
| BP-307       | 12 hours   |

① See page 3-8 for the optional BP-273 battery case battery life.

**NOTE: BE SURE** to replace the battery pack with a new one approximately five years after purchase, even if it still holds a charge. The material inside the battery cells will become weak after a period of time, even with little use.





The estimated number of times you can charge the pack is between 300 and 500. Even when the pack appears to be fully charged, the operating time of the transceiver may become short when:

- Approximately five years have passed since the pack was manufactured.
- The pack has been repeatedly charged.

**TIP:** Keep the battery terminals clean. It's a good idea to clean them occasionally.

### ◇ Battery icon

The "🔋" battery icon is displayed when the battery pack is attached to the transceiver.

| Icon   | Battery status  |
|--|---|
|             | The battery is being charged.   |
|             | The battery has sufficient capacity.  |
|             | The battery is exhausted a little.  |
| <br>(green) | The battery is nearing exhaustion.  |
| <br>(red)   | The battery is almost fully exhausted.<br>① Immediately charge the battery pack.<br>Otherwise, the icon will soon start blinking, "LOW BATTERY" will be displayed, and the transceiver will automatically turn OFF.                         |
| No icon  | When an external DC power supply (12 V DC) is connected, the battery is not being charged because: <ul style="list-style-type: none"> <li>• The battery is completely charged.</li> <li>• "Charging (Power ON)" is set to "OFF."</li> </ul> |

① The battery icon for the BP-273 cannot display the capacity of the alkaline batteries. The battery icon always displays "🔋" and it does not reflect with the true battery capacity.

#### To display the correct battery status

Select the attached battery pack in the following item. (Default: BP-271/BP-272)

([MENU] > SET > Function > **Battery Pack Select**)

To display the Battery Pack Select dialog every time you attach the battery pack, set the following item to "ON."

([MENU] > SET > Function > **Battery Pack Confirmation**)

## 3 BATTERY CHARGING

### Charging information

#### NOTE:

- Prior to using the transceiver for the first time, the battery pack must be fully charged for optimum life and operation.
- **BE SURE** to turn OFF the transceiver while charging with the supplied battery charger. Otherwise, the battery pack will not charge.

- ① While charging, the charging icon “” and “Charging...” are displayed.
- ① The icon and “Charging...” disappear when the battery pack is fully charged.

#### ◇ Charging through the [DC IN] jack

The approximate battery life (operating time) as shown below is calculated under the following assumptions:

- When using the optional CP-12L or OPC-254L, the battery pack can be charged with the power ON.  
(p. 3-7)  
① To connect, see the illustration below.
- The BP-273 battery case has no charging capability or socket.

#### Approximate charging time

- BP-271: 3 hours
- BP-272: 5 hours
- BP-307: 8 hours

To charge the battery pack:

- Use the supplied battery charger or optional cable.
- Use a USB cable (User supplied). (p. 3-4)
- Use the optional rapid charger. (p. 3-6)

#### Charging note

- **CAUTION: BE SURE** to attach the battery pack before connecting the DC cable.
- Turn OFF the transceiver when using the BC-167S.
- **DO NOT** charge the fully charged battery pack. This may cause a shorter battery life.

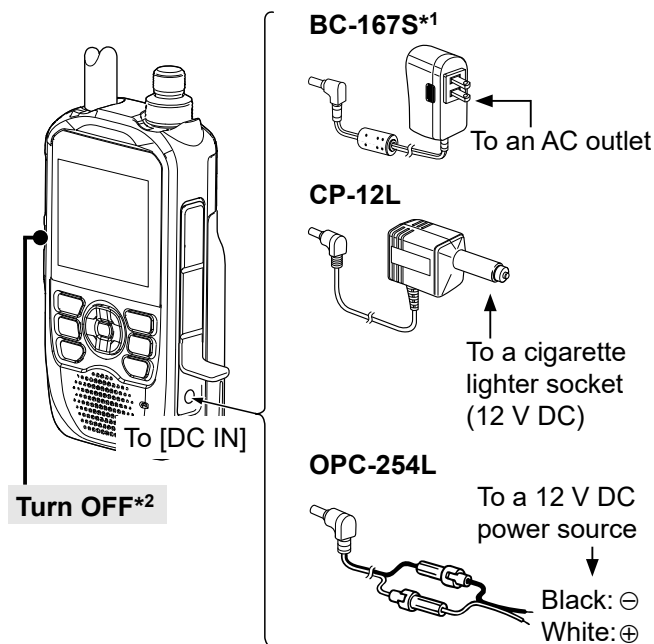

\*1 The shape is different, depending on the version.

\*2 When using the BC-167S, turn OFF the transceiver.

## 3 BATTERY CHARGING

### Charging information

#### ◇ Charging with a USB cable

You can charge the battery pack with a USB cable (micro B type) while operating the transceiver.

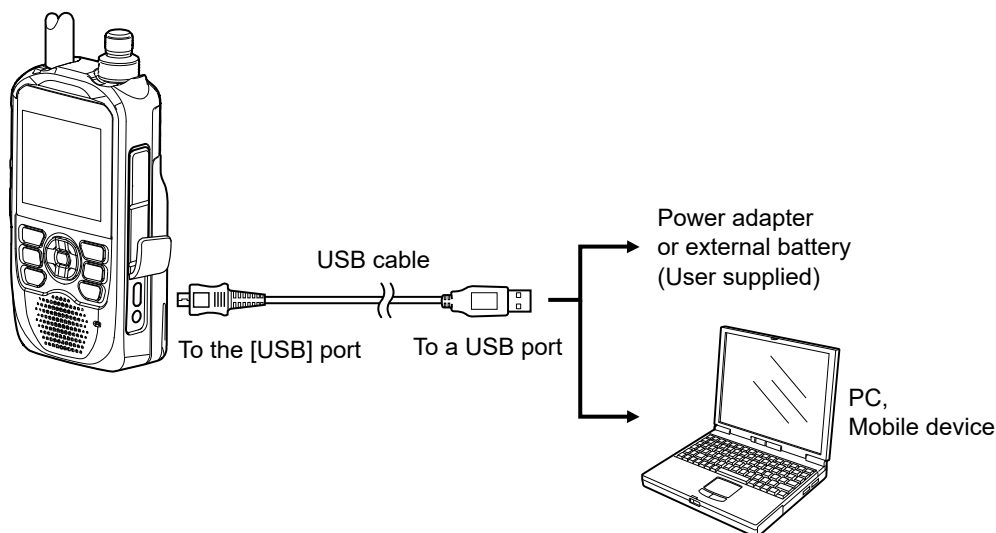

#### NOTE:

- **BE SURE** to attach the battery pack to the transceiver.
- To use a mobile device or a PC as an external power source, set the following item to "ON" (default).  
([MENU] > SET > Function > **USB Power Input (Phone, Tablet, PC)**)
- The battery pack is used as a power source while transmitting, even when an external power source is connected. Therefore, you cannot transmit if the battery pack is exhausted.
- You may not be able to charge:
  - Depending on your USB cable or power adapter.
  - When using a USB hub or connecting to a low output USB port.
- Charging time may differ, depending on the USB port.
- The S-meter may appear, or the noise may occur, due to the influence of the USB power supply's noise. In that case, unplug the USB cable to disconnect the transceiver from the USB power supply.
- When operating the transceiver while charging, the charging may not be sufficient, and the battery pack may be consumed, depending on the power adapter.

#### TIP:

- When a USB cable is connected, the charging is stopped when the battery is fully charged. After that, the charging will resume when a certain amount of capacity is consumed while connecting the USB cable.
- You can change the operation when the transceiver is connected to a PC through a USB cable.  
([MENU] > SET > Function > **USB Connect**)

## Charging with the BC-202IP2 optional rapid charger

The optional BC-202IP2 rapidly charges a battery pack.

① When about 90% of the battery capacity is charged, the BC-202IP2 stops charging and the charging indicator lights green. Therefore, the battery life will be a little shorter than when charging with the transceiver.

### Approximate charging time

- BP-271: 1.5 hours
- BP-272: 2.5 hours
- BP-307: 4 hours

① These are the time when the battery is exhausted, and charging with the transceiver power off.

The following item is required.

- BC-123S (L-shaped type plug)  
(A different type, or no power adapter is supplied, depending on the charger versions.)

### Charging note

⚠ **DANGER! NEVER** use a battery pack that is not manufactured or approved by Icom.

- **CAUTION: DO NOT** connect anything to the [DC IN] jack or the [USB] port on the side of the transceiver when placing the transceiver to the rapid charger. This may cause the charger's malfunction. If the charging indicator blinks orange, disconnect the power adapter from the charger, and then reconnect it.
- **BE SURE** to turn OFF the transceiver. When the transceiver power cannot be turned OFF because of the battery exhaustion, detach the battery pack from the transceiver. Then charge the battery pack by itself.
- The BC-202IP2 RAPID CHARGER can only charge the BP-271, BP-272, or BP-307 Li-ion BATTERY PACK. Other types of rechargeable batteries, Ni-Cd, or Ni-MH cannot be charged.
- If the charging indicator blinks orange, there may be a problem with the battery pack or charger. Contact your dealer if you have problems charging a new battery pack.

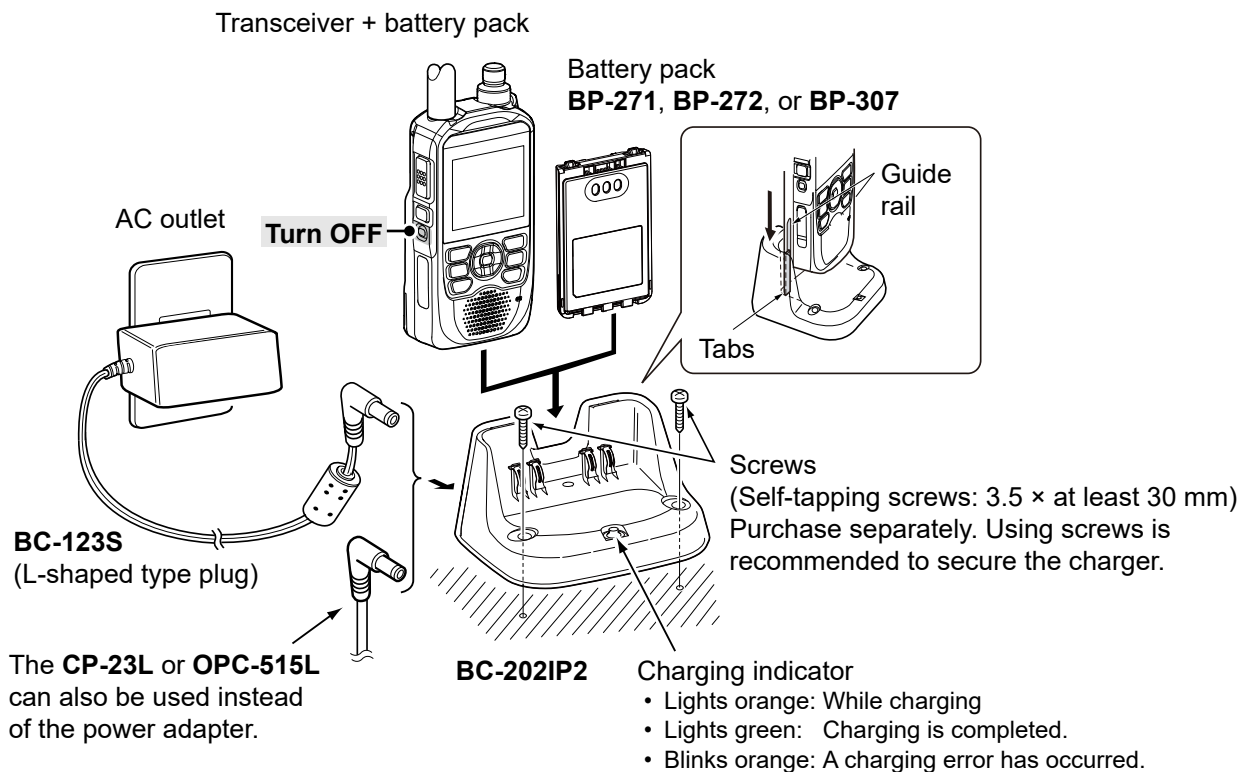

## Charging with the BC-202IP3L optional rapid charger

The optional BC-202IP3L rapidly charges a battery pack.

① When about 90% of the battery capacity is charged, the BC-202IP3L stops charging and the charging indicator lights green. Therefore, the battery life will be a little shorter than when charging with the transceiver.

### Approximate charging time

- BP-271: 2 hours
- BP-272: 3 hours
- BP-307: 5 hours

① These are the time when the battery is exhausted, and charging with the transceiver power off.

The following item is required.

- BC-123S (straight type plug)

### Charging note

⚠ **DANGER! NEVER** use a battery pack that is not manufactured or approved by Icom.

- **CAUTION: DO NOT** connect anything to the [DC IN] jack or the [USB] port on the side of the transceiver when placing the transceiver to the rapid charger. This may cause the charger's malfunction. If the charging indicator blinks orange, disconnect the power adapter from the charger, and then reconnect it.
- **BE SURE** to turn OFF the transceiver. When the transceiver power cannot be turned OFF because of the battery exhaustion, detach the battery pack from the transceiver. Then charge the battery pack by itself.
- The BC-202IP3L RAPID CHARGER can only charge the BP-271, BP-272, or BP-307 Li-ion BATTERY PACK. Other types of rechargeable batteries, Ni-Cd, or Ni-MH cannot be charged.
- If the charging indicator blinks orange, there may be a problem with the battery pack or charger. Contact your dealer if you have problems charging a new battery pack.

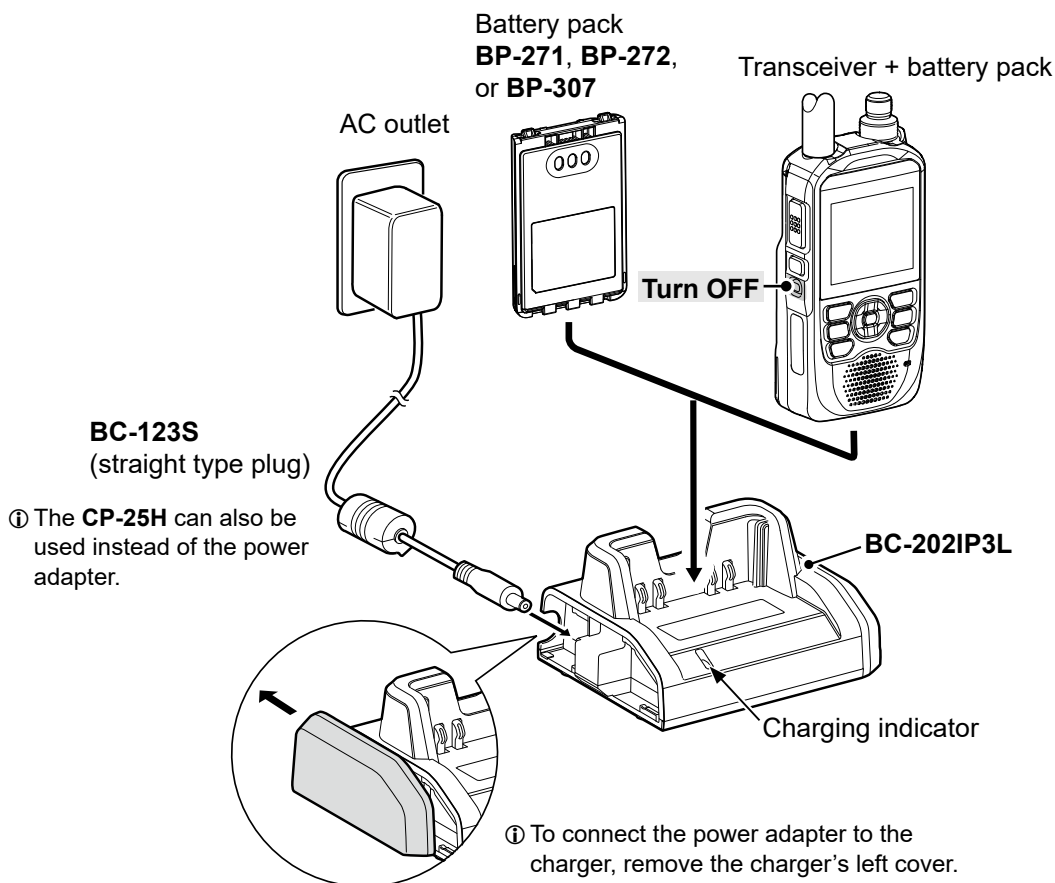

### 3 BATTERY CHARGING

## Connecting BC-202IP3L together

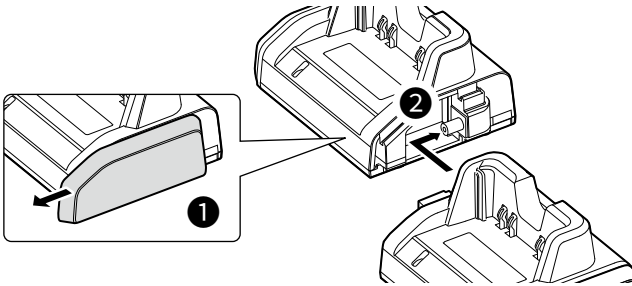

You can connect up to 6 BC-202IP3L together.

1. Remove the charger's right cover. (1)
2. Snap the DC power plug to the another charger's DC power jack. (2)

⚠ **WARNING! NEVER** connect more than 6 chargers together. It may result in an electric shock, cause a fire, overheating, or damage the chargers.  
⚠ **WARNING! NEVER** use other than the BC-228 AC adapter when connecting multiple BC-202IP3L units. It may result in an electric shock, cause a fire, overheating, or damage the chargers.

## External DC power operation

### Operating note

- **DO NOT** connect over 16 V DC directly into the [DC IN] jack of the transceiver. The power source voltage must be between 10.0 V ~ 16.0 V DC.
- **DO NOT** transmit at high power for a long period of time. The transceiver becomes hot, and it may cause a burn.
- Use the optional CP-12L or OPC-254L when using the external DC power.
- Confirm the correct polarity of the OPC-254L supply connection. Connect the OPC-254L to an external power source (user supplied).
- Use an external DC-DC converter to connect the transceiver through the optional CP-12L or OPC-254L to a 24 V DC power source. Ask your dealer for details.
- When the external power is used, the Power Save function (p. 12-18) is automatically turned OFF.
- Depending on the external power voltage, the battery pack may be used to operate the transceiver, and the battery pack capacity is consumed.

**TIP:** The battery pack can be charged even if the transceiver is ON when "Charging (Power ON)" is set to "ON" (default). This operation may generate certain spurious signals, and the S-meter may appear, or noise may be heard. When you operate the transceiver while charging, and if you cannot receive signals correctly, set "Charging (Power ON)" to "OFF."  
([MENU] > SET > Function > **Charging (Power ON)**)

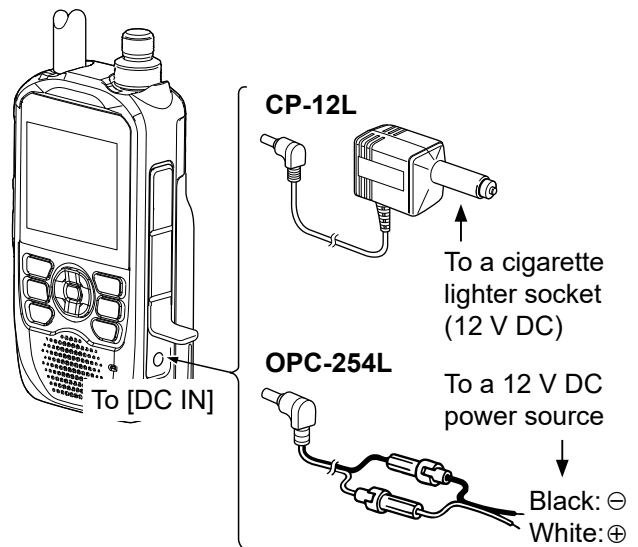

**CAUTION: BE SURE** to attach the battery pack before connecting the DC cable.

- ① The BC-167S cannot be used for external DC power operation.

## 3 BATTERY CHARGING

### About the optional battery case

The BP-273 uses three AA (LR6) size alkaline batteries.

1. Remove the battery case top, as shown below.
2. Install three AA (LR6) size alkaline batteries.
  - ① Install only alkaline batteries.
  - ① BE SURE to observe the correct polarity.
3. Attach the battery case. (p. 1-2)

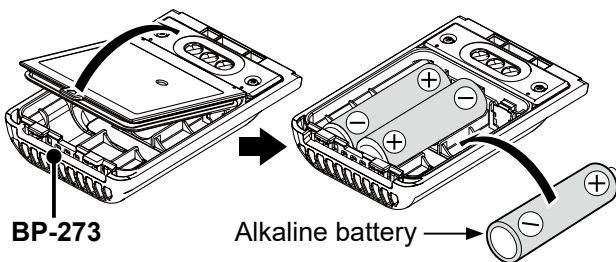

#### Batteries cautions

- When installing batteries, confirm that they are all the same brand, type, and capacity. Do not mix new and old batteries together.
- **DO NOT** incinerate used battery cells since the internal battery gas may cause them to rupture.
- **DO NOT** expose a detached battery case to water. If the battery case gets wet, **BE SURE** to wipe it dry before using it.
- **DO NOT** use batteries whose insulated covering is damaged.
- Keep the battery terminals clean. It's a good idea to clean them occasionally.
- Remove the alkaline batteries when the battery case is not used. Otherwise, the installed alkaline batteries will be exhausted due to the built-in step-up converter.

#### TIP:

- A built-in step-up converter in the BP-273 increases the voltage to 5.5 V DC. Approximately 100 mW of output power is possible using the case. Also, the transmit output power selection is disabled.
- The transceiver meets IPX4 requirements for waterproof protection when the BP-273 is attached.
- The batteries may seem to have low capacity when used in low temperatures, such as  $-10^{\circ}\text{C}$  ( $+14^{\circ}\text{F}$ ) or below. Keep the batteries warm in this case.

#### ◇ Battery life

The approximate battery life (operating time), as shown below, is calculated under the following assumptions:

- Power save setting: Auto (Short)
- Duty cycle: TX : RX : Stand-by = 1 : 1 : 8  
(based on operating style)

#### The approximate battery life:

| FM mode   |
|-----------|
| 4.5 hours |

- ① The battery life may differ, depending on your operating style, or the installed alkaline batteries.

#### ◇ About the battery replacement

When the alkaline batteries are almost exhausted, "LOW BATTERY" is displayed, and the battery icon starts to blink. After 10 seconds, the transceiver power is automatically turned OFF. In that case, replace all 3 batteries with new alkaline batteries.

- ① The battery icon for the BP-273 cannot display the capacity of the alkaline batteries. The battery icon always displays "🔋," and it does not reflect with the true battery capacity.

## Specifications for the battery charger and battery packs

### ◇ BP-271 Li-ion BATTERY PACK (optional)

- Voltage: 7.4V
- Discharge Capacity: 1150 mAh (minimum)
- Usable temperature range:  $-20^{\circ}\text{C} \sim +60^{\circ}\text{C}$ ,  $-4^{\circ}\text{F} \sim +140^{\circ}\text{F}$
- Charging temperature range:  $0^{\circ}\text{C} \sim 40^{\circ}\text{C}$ ,  $32^{\circ}\text{F} \sim 104^{\circ}\text{F}$
- Storage temperature range:  $-20^{\circ}\text{C} \sim +50^{\circ}\text{C}$ ,  $-4^{\circ}\text{F} \sim +122^{\circ}\text{F}$  (within a month)  
 $-20^{\circ}\text{C} \sim +35^{\circ}\text{C}$ ,  $-4^{\circ}\text{F} \sim +95^{\circ}\text{F}$  (within 3 months)  
 $-20^{\circ}\text{C} \sim +20^{\circ}\text{C}$ ,  $-4^{\circ}\text{F} \sim +68^{\circ}\text{F}$  (within a year)
- Dimensions: 58 (W) × 86.9 (H) × 9.1 (D) mm, 2.3 (W) × 3.4 (H) × 0.4 (D) inches  
(projections are not included)

### ◇ BP-272 Li-ion BATTERY PACK (supplied)

- Voltage: 7.4V
- Discharge Capacity: 1880 mAh (minimum)
- Usable temperature range:  $-20^{\circ}\text{C} \sim +60^{\circ}\text{C}$ ,  $-4^{\circ}\text{F} \sim +140^{\circ}\text{F}$
- Charging temperature range:  $0^{\circ}\text{C} \sim 40^{\circ}\text{C}$ ,  $32^{\circ}\text{F} \sim 104^{\circ}\text{F}$
- Storage temperature range:  $-20^{\circ}\text{C} \sim +50^{\circ}\text{C}$ ,  $-4^{\circ}\text{F} \sim +122^{\circ}\text{F}$  (within a month)  
 $-20^{\circ}\text{C} \sim +35^{\circ}\text{C}$ ,  $-4^{\circ}\text{F} \sim +95^{\circ}\text{F}$  (within 3 months)  
 $-20^{\circ}\text{C} \sim +20^{\circ}\text{C}$ ,  $-4^{\circ}\text{F} \sim +68^{\circ}\text{F}$  (within a year)
- Dimensions: 58 (W) × 86.9 (H) × 14.2 (D) mm, 2.3 (W) × 3.4 (H) × 0.6 (D) inches  
(projections are not included)

### ◇ BP-307 Li-ion BATTERY PACK (optional)

- Voltage: 7.2V
- Discharge Capacity: 3050 mAh (minimum)
- Usable temperature range:  $-20^{\circ}\text{C} \sim +60^{\circ}\text{C}$ ,  $-4^{\circ}\text{F} \sim +140^{\circ}\text{F}$
- Charging temperature range:  $0^{\circ}\text{C} \sim 40^{\circ}\text{C}$ ,  $32^{\circ}\text{F} \sim 104^{\circ}\text{F}$
- Storage temperature range:  $-20^{\circ}\text{C} \sim +50^{\circ}\text{C}$ ,  $-4^{\circ}\text{F} \sim +122^{\circ}\text{F}$  (within a month)  
 $-20^{\circ}\text{C} \sim +40^{\circ}\text{C}$ ,  $-4^{\circ}\text{F} \sim +104^{\circ}\text{F}$  (within 3 months)  
 $-20^{\circ}\text{C} \sim +20^{\circ}\text{C}$ ,  $-4^{\circ}\text{F} \sim +68^{\circ}\text{F}$  (within a year)
- Dimensions: 58 (W) × 86.9 (H) × 22.4 (D) mm, 2.3 (W) × 3.4 (H) × 0.9 (D) inches  
(projections are not included)

### ◇ BC-202IP2 RAPID CHARGER (optional)

- Power source requirement: 12 V ~ 16 V DC or the specified Icom power adapter
- Charging temperature range:  $10^{\circ}\text{C} \sim 40^{\circ}\text{C}$ ,  $50^{\circ}\text{F} \sim 104^{\circ}\text{F}$
- Weight: Approximately 105 g, 3.7 oz (without power adapter)
- Dimensions: 88.0 (W) × 47.5 (H) × 72.5 (D) mm, 3.5 (W) × 1.9 (H) × 2.9 (D) inches  
(projections are not included)

### ◇ BC-202IP3L RAPID CHARGER (optional)

- Power source requirement: 12 V ~ 15 V DC or the specified Icom power adapter
- Charging temperature range:  $10^{\circ}\text{C} \sim 40^{\circ}\text{C}$ ,  $50^{\circ}\text{F} \sim 104^{\circ}\text{F}$
- Weight: Approximately 120 g, 4.2 oz (without power adapter)
- Dimensions: 106.5 (W) × 52.5 (H) × 78.0 (D) mm, 4.2 (W) × 2.1 (H) × 3.1 (D) inches  
(projections are not included)

# Section 4

# FM RADIO OPERATION

---

|   |      |
|---|------|
| Basic operation.....  | 4-2  |
| ◇ Description .....   | 4-2  |
| ◇ Turning ON the FM Radio .....                               | 4-2  |
| ◇ Selecting the FM Radio mode .....                           | 4-3  |
| ◇ Selecting the group in the Memory mode.....                 | 4-3  |
| ◇ Searching for an FM Radio signal .....                      | 4-4  |
| ◇ Using the Attenuator function .....                         | 4-4  |
| ◇ Setting a squelch level .....                               | 4-5  |
| ◇ Using the Monitor function.....                             | 4-5  |
| FM Radio memory.....  | 4-6  |
| ◇ Using the FM Radio Memory.....                              | 4-6  |
| ◇ Add an FM Radio memory .....                                | 4-6  |
| ◇ Editing an FM radio memory .....                            | 4-8  |
| ◇ Deleting an FM Radio memory.....                            | 4-9  |
| ◇ Rearranging the display order of the FM Radio memories..... | 4-10 |
| ◇ Skip setting for the FM Radio memory .....                  | 4-11 |
| Using the FM Radio mode.....                                  | 4-12 |
| FM RADIO items .....  | 4-13 |

## Basic operation

### ◇ Description

You can listen to FM Radio broadcasts. While using the Dualwatch function, you can still listen to the FM Radio on the pop up window. Up to 500 FM Radio Memory channels can be separately stored in the 26 groups for easy memory management. You can standby listening to FM Radio. Also, the transceiver has the exclusive FM Radio mode, where only the FM Radio functions. In this mode, the other functions are disabled.

**TIP:** The FM Radio Memory channel contents, described in this manual, may differ from your transceiver's preloaded contents.

### The frequency range for the FM Radio

FM: 76.0 MHz\* to 108.0 MHz

\* The usable frequency range differs, depending on the transceiver's version.

### ◇ Turning ON the FM Radio

1. Push [QUICK].
2. Select "<<FM Radio ON>>."
  - Returns to the standby screen, and the FM RADIO window is displayed.
  - "FM" is displayed.

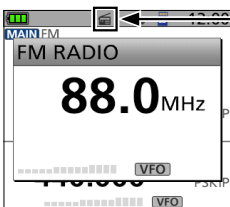

Displayed when the FM Radio is ON.

### TIP:

#### To turn OFF the FM Radio

Push [QUICK], and then select "<<FM Radio OFF>>."

#### To listen to the FM Radio while monitoring the A/B bands

Push [CLR] to close the FM RADIO window.

- You can standby listening to FM Radio.

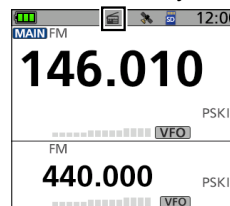

① To open the FM RADIO window again, push [QUICK], and select "<<FM Radio>>."

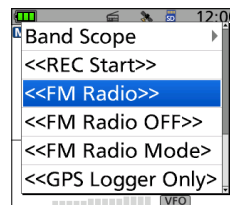

**NOTE:** If you turn ON the Band Scope function while using the Dualwatch function, the FM Radio audio output may be interrupted due to the AF Output (DUAL/AIR Band) function.

In that case, set "Auto Mute" to OFF, or set "AF Output (DUAL/AIR Band)" to OFF.

① When "AF Output (DUAL/AIR Band)" is set to ON, the received audio is momentarily heard during a sweep, and you will know that a signal is received without looking at the display.

([MENU] > FM RADIO > FM Radio Set > Auto Mute)

([MENU] > SET > Scope > AF Output (DUAL/AIR Band))

# 4 FM RADIO OPERATION

## Basic operation

### ◇ Selecting the FM Radio mode

1. When the FM RADIO window is displayed, push [MR] to select between the Tuning and the Memory modes.
2. Rotate [DIAL] to select a frequency or a memory channel.

#### • Tuning mode

The FM Radio Tuning mode is used to set the desired FM Radio frequency.

When the Tuning mode is selected, “VFO” is displayed.

To save the selected frequency, hold down [MR] for 1 second.

- Enters it into the lowest memory channel of the selected group.



Tuning mode

#### • Memory mode

The FM Radio Memory mode is very useful to quickly select often-used frequency settings.

When the Memory mode is selected, “MR” and the selected memory channel group (A ~ Z) and number are displayed.



Memory mode

**TIP:** Push [QUICK], and select “VFO” to select the Tuning mode, or select “MR” to select the Memory mode.

### ◇ Selecting the group in the Memory mode

Up to 50 FM Radio Memory channels can be assigned to each group for easy memory management.

If you change the group, other area channels can be selected.

1. Push [MR] to select the Memory mode.

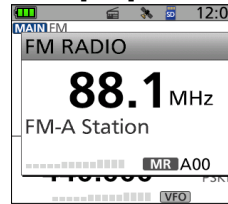

- “MR” and the selected memory channel number is displayed.

2. Push [QUICK].
3. Select “Group Select.”

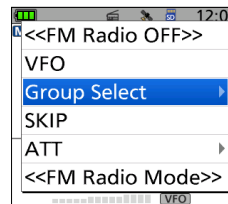

4. Select the desired group.

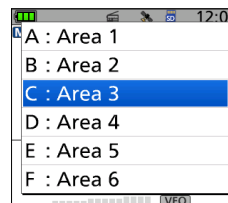

- Returns to the standby screen, and the memory channel in the selected group is displayed.

5. Rotate [DIAL] to select a memory channel.

## 4 FM RADIO OPERATION

### Basic operation

#### ◇ Searching for an FM Radio signal

While in the Tuning mode, hold down D-pad(↔) to start searching the broadcast signal.

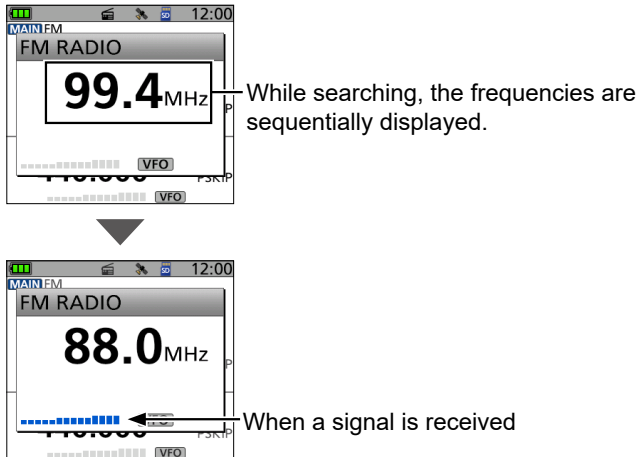

- When you hold down D-pad(←), a down scan starts, and when you hold down D-pad(→), an up scan starts.
- When a signal is received, the scan stops on the frequency.
- To cancel the scan, push D-pad(↔) or [CLR].

#### ◇ Using the Attenuator function

The Attenuator prevents a desired signal from becoming distorted when a very strong FM Radio signal is near the frequency, or when a very strong electric field, such as from a broadcasting station, is near your location.

1. Push [QUICK].
2. Select "ATT."



3. Select "ON."

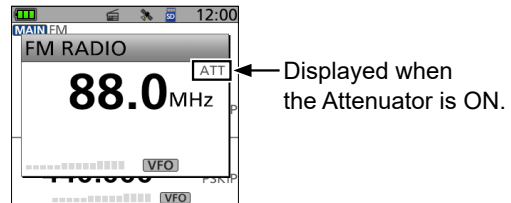
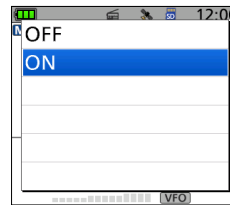

- "ATT" is displayed.

## 4 FM RADIO OPERATION

### Basic operation

#### ◇ Setting a squelch level

The squelch enables the audio to be heard only while receiving a signal that is stronger than the set level. A higher level blocks weak signals, which enables you to receive only stronger signals. A lower level enables you to hear weak signals.

The squelch level that is set on the FM RADIO window is only for the FM Radio.

While holding down [SQL], rotate [DIAL] to select the squelch level.

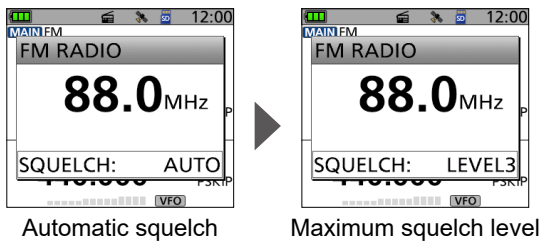

#### ① Information

- Options: "OPEN," "AUTO" (default), and "LEVEL 1" ~ "LEVEL 3"
- "LEVEL 1" is loose squelch (for weak signals), and "LEVEL 3" is tight squelch (for strong signals).
- "AUTO" is an automatic level adjustment using a noise pulse counting system.
- "OPEN" is the continuously open setting.

#### ◇ Using the Monitor function

The Monitor function is used to listen to weak FM Radio signals without changing the squelch setting.

While holding down [SQL], the transceiver monitors weak signals on the frequency.

- The squelch opens.

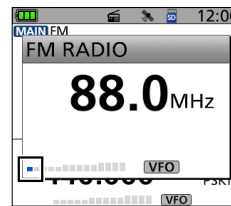

The first segment blinks.

**TIP:** You can set the Monitor Hold function on the MENU screen. The transceiver opens or closes the squelch each time you push [SQL].  
([MENU] > SET > Function > **Monitor**)

## FM Radio memory

### ◇ Using the FM Radio Memory

A total of 26 groups are selectable for FM Radio memory.

You can assign up to 50 FM Radio memory channels to each group, for easy memory management. (A maximum of 500 memories can be assigned to the FM Radio memory.)

Some area stations are preloaded into the FM Radio memory for easy memory management.

**TIP:** The FM Radio memory contents, described in this manual, may differ from your transceiver's programmed memory.

### ◇ Add an FM Radio memory

#### Step 1. Adding an FM Radio memory and entering the edit mode

[MENU] > FM RADIO > **FM Radio Memory**

1. Push [MENU].
2. Select "FM Radio Memory" in the "FM RADIO" menu.



3. Select a desired group.



① If there is no memory, "-- Blank --" is displayed.

4. Push [QUICK].
5. Select "Add."

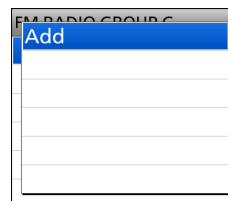

- The FM RADIO MEM EDIT screen is displayed.

**TIP:** To change the group name, push [QUICK], and then select "Edit Name" in step 4.

# 4 FM RADIO OPERATION

## FM Radio memory

### ◇ Add an FM Radio memory

#### Step 2. Entering an FM Radio Memory name

1. Select "NAME."

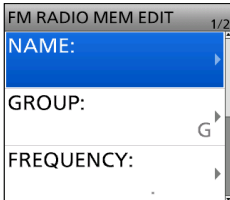

2. Enter a name.

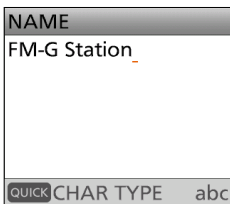

① See page iii on how to enter characters.

3. After entering, push [ENT].

**TIP:** To change the FM Radio memory group, select "GROUP," then select the desired group.

#### Step 3. Entering a frequency

1. Select "FREQUENCY."

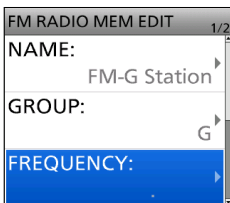

2. Rotate [DIAL] to enter the frequency.

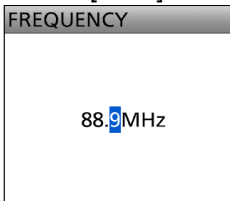

① Push D-pad(↔) to move the cursor.

① The usable frequency range differs, depending on the transceiver's version.

3. After entering, push [ENT].

#### Step 4. Selecting the skip setting

1. Select "SKIP."

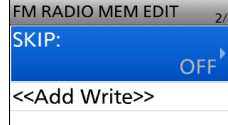

2. Select "OFF" or "SKIP."



- **OFF:** You can select the memory in the Memory mode.
- **SKIP:** The memory is not displayed in the Memory mode.

#### Step 5. Saving the FM Radio Memory

1. Select "<<Add Write>>."



2. Select "YES."

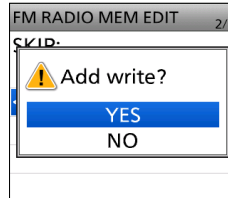

- The entered contents are saved in the FM Radio memory, and the display returns to the selected group screen.

#### **TIP: How to cancel the entered data:**

1. Push [CLR].
2. Select "YES."

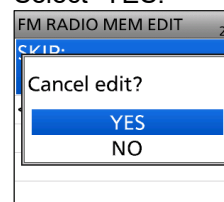

- Cancels the entry, and returns to the selected group screen.

## 4 FM RADIO OPERATION

### FM Radio memory

#### ◇ Editing an FM radio memory

This function edits FM Radio memory contents. This is useful when already-entered data is incorrect, has changed, or new data should be added to the list.

#### [MENU] > FM RADIO > FM Radio Memory

1. Push [MENU].
2. Select "FM Radio Memory" in the "FM RADIO" menu.



3. Select a group that includes the memory you want to edit.

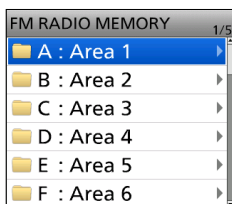

4. Select the memory to be edited.

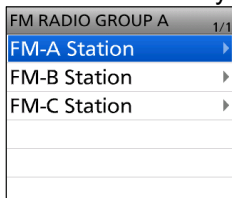

① **DO NOT** push [ENT].

5. Push [QUICK].
6. Select "Edit."

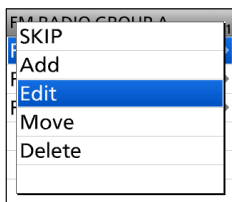

7. Select an item, then edit it.

① See page 4-7 for details.

8. After editing, select "<<Overwrite>>."

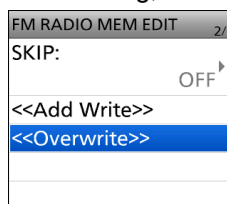

9. Select "YES."



- The memory contents are overwritten, and returns to the selected group screen.

## 4 FM RADIO OPERATION

### FM Radio memory

#### ◇ Deleting an FM Radio memory

All the contents of an FM Radio memory can be deleted.

**NOTE:** Deleted memories cannot be restored.

[MENU] > FM RADIO > **FM Radio Memory**

1. Push [MENU].
2. Select "FM Radio Memory" in the "FM RADIO" menu.

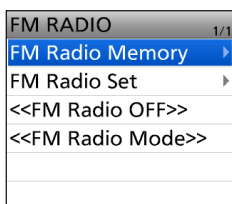

3. Select a group that includes the memory you want to delete.

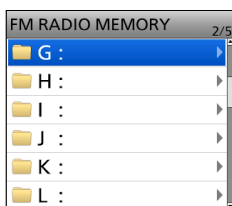

4. Select the memory to be deleted.



ⓘ **DO NOT** push [ENT].

5. Push [QUICK].
6. Select "Delete."

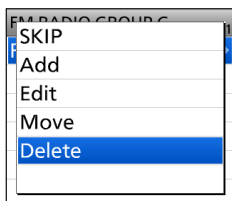

7. Select "YES."

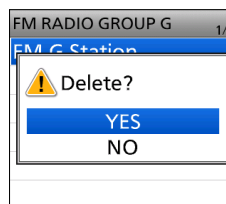

- The selected FM Radio memory is deleted.

## 4 FM RADIO OPERATION

### FM Radio memory

#### ◇ Rearranging the display order of the FM Radio memories

You can move the entered FM Radio memories to rearrange their display order in the selected FM Radio memory group.

##### [MENU] > FM RADIO > FM Radio Memory

1. Push [MENU].
2. Select "FM Radio Memory" in the "FM RADIO" menu.



3. Select a group that includes the memory you want to move.

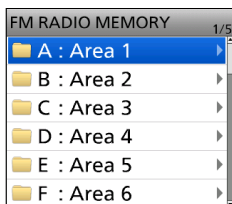

4. Select the memory to be moved.

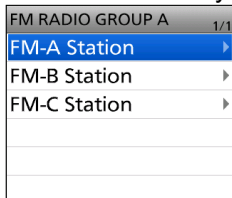

① **DO NOT** push [ENT].

5. Push [QUICK].
6. Select "Move."

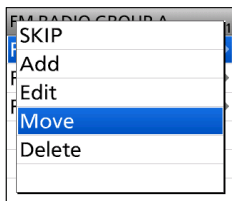

7. Select a memory to insert the repeater you want to move above it.

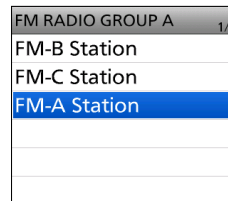
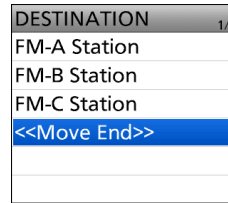

- The selected memory is inserted above the destination memory.

- ① If you select "<<Move End>>," the memory is moved to the bottom of the group.

## 4 FM RADIO OPERATION

### FM Radio memory

#### ◇ Skip setting for the FM Radio memory

You can set memories as skip memories. The selected memories are not displayed in the Memory mode.

#### [MENU] > FM RADIO > FM Radio Memory

1. Push [MENU].
2. Select "FM RADIO."
3. Select "FM Radio Memory."

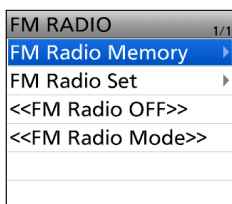

4. Select a group that includes the memory you want to set the skip setting on.

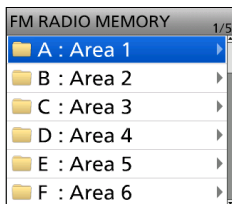

5. Select the memory to be skipped.

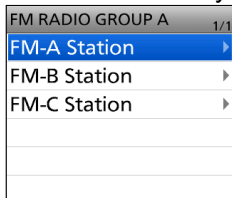

ⓘ **DO NOT** push [ENT].

6. Push [QUICK].

7. Select "SKIP."

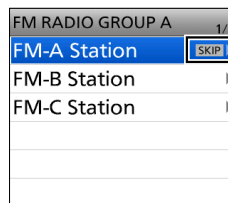
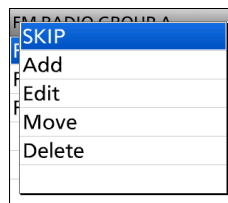

- "SKIP" is displayed on the selected memory.
- ⓘ Push [QUICK], and then select "SKIP" again to cancel the skip setting.

**TIP:** When displaying the FM RADIO window in the Memory mode, push [QUICK], and selecting "SKIP" also sets the skip setting.

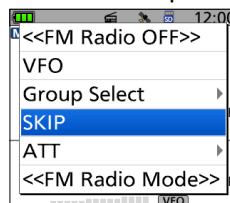

## 4 FM RADIO OPERATION

### Using the FM Radio mode

The transceiver has an exclusive FM Radio mode where only the FM Radio functions.

1. Push [QUICK].
2. Select “<<FM Radio Mode>>.”



- The FM Radio mode screen is displayed.

**TIP: To cancel the FM Radio mode**

1. Push [QUICK].
2. Select “<<Normal Mode>>.”
  - ① In the exclusive FM Radio mode, the other modes are in a sleep state. To operate the transceiver in a normal way, cancel the FM Radio mode.

## FM RADIO items

### FM Radio Memory

[MENU] > FM RADIO > **FM Radio Memory**

A total of 26 groups are selectable for FM radio Memories.  
 You can assign up to 50 memories to each group, for easy memory management. (A maximum of 500 memories can be assigned to the FM Radio Memory.)

#### FM Radio memory contents

|           |   |
|-----------|---|
| NAME      | The name of an FM Radio memory channel<br>① Enter a name of up to 16 alphanumeric characters for each memory. |
| GROUP     | The group letter and the name of the group  |
| FREQUENCY | Entered frequency<br>① The usable frequency range differs, depending on the transceiver's version.            |
| SKIP      | Shows the skip status.<br>① The Skip channels are not displayed in the Memory mode.                           |

### Auto Mute (Default: 2sec)

[MENU] > FM RADIO > FM Radio Set > **Auto Mute**

Selects whether or not to mute the FM Radio audio in the background\* while receiving a signal on the A or B band.

① The FM Radio audio is muted while transmitting, regardless of this setting.

\* See "To listen to the FM Radio while monitoring the A/B bands" on page 4-2 for details.

- OFF: The Auto Mute function is OFF. The FM Radio audio is not muted even if the transceiver receives a signal on the A or B band. The FM Radio audio is muted when the transceiver transmits.
- 0 to 10sec: The FM Radio audio is automatically muted when the transceiver transmits or receives on the A or B band. After transmitting or receiving, the Auto Mute timer starts. After the timer period ends, you can listen to FM Radio again.  
 ① The FM Radio audio is muted when a signal is received during a sweep by the Band Scope function.

### Earphone Antenna (Default: Not Used)

[MENU] > FM RADIO > FM Radio Set > **Earphone Antenna**

Selects whether or not to use the earphone antenna for FM radio.

- Not Used: An earphone antenna is not used.
- Use: An earphone antenna is used.

### Power Save (FM Radio) (Default: ON)

[MENU] > FM RADIO > FM Radio Set > **Power Save (FM Radio)**

Sets the power save function to reduce the current drain and conserve battery power when the FM Radio is ON.

- OFF: The power save function is OFF.
- ON: When the FM Radio is ON, and no signal is received for 5 seconds, this function is activated in a 1:3 ratio (300 : 900 milliseconds).

**NOTE:** This function is disabled when an external power source is used.

### <<FM Radio ON>>

[MENU] > FM RADIO > <<FM Radio ON>>

Turns ON the FM Radio.

When the transceiver receives on the MAIN band and SUB band, you can still listen to the FM Radio. When the FM Radio is ON, <<FM Radio OFF>> is displayed on the FM RADIO screen. To turn OFF the FM Radio, select <<FM Radio OFF>>.

① In the Quick Menu window, selecting <<FM Radio OFF>> also turns OFF the FM Radio.

### <<FM Radio Mode>>

[MENU] > FM RADIO > <<FM Radio Mode>>

The transceiver enters an exclusive FM Radio mode where only the FM Radio functions.

While in the FM Radio Mode, <<Normal Mode>> is displayed on the FM RADIO screen. To exit from the FM Radio mode, select <<Normal Mode>>.

① In the Quick Menu window, selecting <<Normal Mode>> also exits from the FM Radio mode.

# Section 5

# D-STAR OPERATION (ADVANCED)

**NOTE:** See D-STAR GUIDE on the Basic manual for details on how to register your call sign to a gateway repeater and the basic operations.

- “FROM” (access repeater) setting .....5-3
  - ◇ Using your transceiver’s repeater list .....5-4
  - ◇ Using the DR scan .....5-5
  - ◇ Using the Near Repeater Search function.....5-6
  - ◇ Using TX History.....5-7
- “TO” (Destination) setting .....5-8
  - ◇ Making the “Local CQ” (Local Area call).....5-9
  - ◇ Making a “Gateway CQ” (Gateway call).....5-9
  - ◇ Using “Your Call Sign” .....5-10
  - ◇ Using RX History .....5-10
  - ◇ Using TX History.....5-11
  - ◇ Directly entering (UR).....5-11
  - ◇ Directly entering (RPT).....5-12
- REPEATER DETAIL screen .....5-13
- Connecting to a reflector .....5-14
  - ◇ What is a reflector? .....5-14
  - ◇ Unlinking a reflector.....5-14
  - ◇ Linking to a reflector .....5-15
  - ◇ Using a reflector .....5-16
  - ◇ Reflector Echo testing .....5-16
  - ◇ Requesting repeater information .....5-16
- Message operation .....5-17
  - ◇ Entering a TX message .....5-17
  - ◇ Transmitting a message .....5-17
  - ◇ Deleting a TX message .....5-18
- Viewing received call signs.....5-19
  - ◇ Viewing the call signs on the RX History screen .....5-19
- BK mode communication.....5-21
- EMR communication .....5-22
  - ◇ Adjusting the EMR AF level.....5-22
- Automatic DV detection .....5-23
- Automatic Reply function.....5-24
  - ◇ Recording an Auto Reply message .....5-25
  - ◇ Auto Position Reply function .....5-26

|   |      |
|---|------|
| Data communication.....                                 | 5-27 |
| ◇ Connection .....                                      | 5-27 |
| ◇ Data communication application setting.....           | 5-27 |
| ◇ Sending data .....                                    | 5-27 |
| ◇ DV Fast Data function .....                           | 5-28 |
| About the display type .....                            | 5-28 |
| Digital squelch functions.....                          | 5-29 |
| ◇ The Digital Call Sign squelch setting.....            | 5-29 |
| ◇ The Digital Code Squelch setting.....                 | 5-29 |
| Repeater list .....                                     | 5-30 |
| ◇ Repeater list contents.....                           | 5-30 |
| Entering new information into the repeater list.....    | 5-31 |
| ◇ Required items for the communication cases .....      | 5-31 |
| ◇ Entering new information into the repeater list.....  | 5-32 |
| Repeater list operation .....                           | 5-36 |
| ◇ Editing repeater data .....                           | 5-36 |
| ◇ Deleting repeater data.....                           | 5-36 |
| ◇ Rearranging the display order of the repeaters.....   | 5-37 |
| ◇ Adding new repeater information from RX History.....  | 5-38 |
| ◇ Skip setting for the DR scan.....                     | 5-39 |
| ◇ Entering or editing a repeater group name.....        | 5-40 |
| Your Call Sign.....                                     | 5-41 |
| ◇ Entering Your Call Sign .....                         | 5-41 |
| ◇ Deleting Your Call Sign.....                          | 5-42 |
| ◇ Rearranging the display order of Your Call Signs..... | 5-43 |
| Are your settings correct?.....                         | 5-44 |

**IMPORTANT!**

- The repeater list, described in this manual, may differ from your transceiver's preloaded contents.
- Although Japanese repeaters are used in the setting examples, the Japanese repeater node (port) letters are different from other country's. **BE SURE** to add the repeater node letter in the 8th digit of the call sign, according to the frequency band shown below.  
1200 MHz: A (B in Japan)  
430 MHz: B (A in Japan)  
144 MHz: C (no repeaters in Japan)

**To begin the Digital mode communication using other than the D-STAR Repeater (DR) function**

To begin Digital mode communication using other than the DR function, you can use the VFO mode, Memory mode, or Call Channel mode.

This manual description focuses on the DR function operation, which can be easily set up. If you want to use other than the DR function, see the procedures as described to the right, or select the repeater in a Memory channel.

**For a Local area call or Gateway call:**

1. Set the access repeater's frequency. (p. 11-2)
2. Set the Duplex direction and frequency offset. (p. 11-4)
3. Set the call signs (UR/R1/R2). (p. 12-8)

**For a Simplex call:**

1. Set the operating frequency.
2. Set the call signs (UR/R1/R2). (p. 12-8)

## 5 D-STAR OPERATION (ADVANCED)

### “FROM” (access repeater) setting

Your access repeater must be set in “FROM” when you make a call on the DR screen. You have 5 ways to select the access repeater.

#### By rotating [DIAL]

Select the preset repeater on the DR screen by rotating [DIAL].

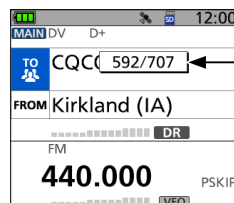

Displayed while rotating [DIAL]

#### • When you know your access repeater

##### From the repeater list (p. 5-4)

When your access repeater is in your transceiver's repeater list, you can select it by selecting the repeater area and name, if entered, or call sign.

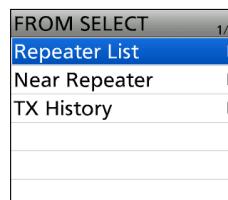

#### • When you do not know which repeaters you can access

##### Search for a repeater using the DR scan (p. 5-5)

The Normal DR scan searches for output repeater frequencies of nearby repeaters. The scan stops when a signal is detected. The scan also stops on Simplex signals.

The Near Repeater scan searches for output repeater frequencies of nearby repeaters by using your location and the repeater's location, if it is entered in the Repeater List. The DR scan starts scanning and stops when a signal is detected.

You can also find only FM repeaters using the Near Repeater (FM) scan.

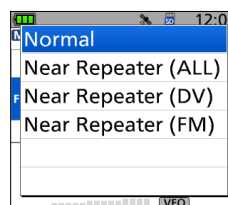

Scan items

##### Search for near repeaters (p. 5-6)

The transceiver scan searches for near repeaters by using your location and the repeater's location, if it is entered in the Repeater List.

The nearest repeaters in your transceiver's repeater list are displayed as selectable options.

You can select the nearby DV or FM repeater type.

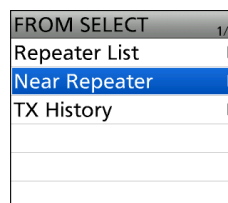

#### • When “FROM” data is saved in the TX History.

##### Select from the TX History (p. 5-7)

Select a repeater that you have accessed before from the TX History record.

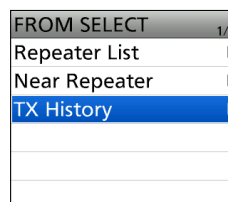

# 5 D-STAR OPERATION (ADVANCED)

## “FROM” (access repeater) setting

### ◇ Using your transceiver’s repeater list

When your access repeater is in your transceiver’s repeater list, you can select it from the list. By just selecting the repeater from the list, the repeater call sign, its frequency, duplex setting, and frequency offset are automatically set, for easy operation.

**Example:** Selecting the “Kirkland (IA)” repeater in Washington state in the USA from the repeater list.

1. Hold down [DR] for 1 second to display the DR screen.
2. Push D-pad(↓) to select “FROM,” and then push [ENT].



3. Select “Repeater List.”

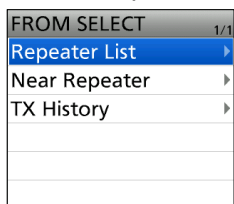

4. Select the repeater group where your access repeater is listed.

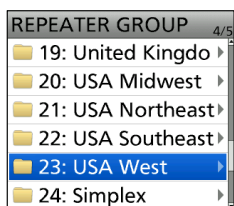

5. Select your access repeater.

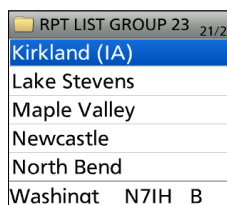

- Returns to the DR screen, and the selected repeater name is displayed in “FROM.”
- ① The repeater list, described in this manual, may differ from your transceiver’s preloaded contents.

#### TIP:

#### When you select an FM repeater:

When an FM repeater is in your transceiver’s repeater list, you can select it from the list. When selecting an FM repeater, the “TO” setting is not necessary, and a “——” is displayed in “TO.”

When selecting an FM repeater.

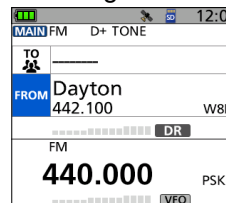

#### How to change the repeater group:

To change the repeater group on the DR screen, push [QUICK], then select “Group Select.”

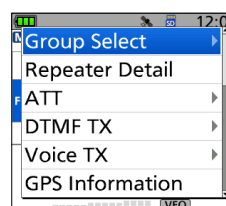

# 5 D-STAR OPERATION (ADVANCED)

## “FROM” (access repeater) setting

### ◇ Using the DR scan

The DR scan scans frequencies to find a signal on a repeater, or on a simplex frequency.

You can use 2 kinds of DR scans, Normal scan and Near Repeater scan.

#### Normal scan

To quickly find a repeater, the Normal scan skips repeaters that are not set as an access repeater.

① The “USE (FROM)” setting (p. 5-33) is set to “NO” on the repeater list.

([MENU] > MEMORY > **Repeater List**)

#### Near Repeater scan

The Near Repeater scan searches for up to 20 nearby repeaters within 160 kilometers (100 miles) by using your location and the repeater’s entered position data, and then lists the repeaters.

① The Near Repeater scan continues, even if you turn OFF the transceiver, and then turn it ON again during the scan.

① If your own position data is not being received from GPS satellites, the last received position data is used.

**NOTE:** Even if your transceiver receives a repeater signal, the repeater may not receive your signal, because the repeater’s output power is higher than your transceiver’s, and your signal does not reach the repeater.

**TIP:** The DR scan scans the simplex frequencies in the repeater list, in addition to D-STAR repeaters.

**Example:** Selecting an active repeater using the DR scan.

1. Hold down [DR] for 1 second to display the DR screen.
2. Hold down [SCAN] for 1 second.

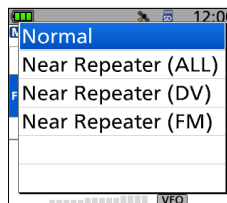

3. Select the scan type.
  - **Normal:** Searches for repeaters whose “USE (FROM)” setting is set to “YES.”
  - **Near Repeater (ALL):** Searches for up to 20 each of nearby DV or FM repeaters. (Total 40 repeaters)
  - **Near Repeater (DV):** Searches for up to 20 nearby DV repeaters.
  - **Near Repeater (FM):** Searches for up to 20 nearby FM repeaters.
- The selected scan starts.
- In the DR scan, the repeaters are sequentially displayed by distance, in descending order.
- ① The scan resumes the same as other scans. (p. 12-5)



← The repeaters are sequentially displayed.

4. When the transceiver receives a signal from a repeater, the scan stops. Push [SCAN].

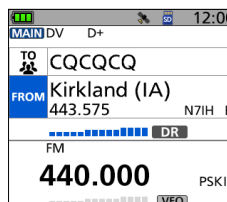

- The DR scan is canceled, and the repeater is set to “FROM.”



# 5 D-STAR OPERATION (ADVANCED)

## “FROM” (access repeater) setting

### ◇ Using the Near Repeater Search function

The transceiver searches for the nearest repeaters by using your location and the repeater’s entered position data.

The nearest repeaters in your transceiver’s repeater list are displayed as selectable options.



**NOTE:**

- When using the Near Repeater Search function, **BE SURE** first to receive your own GPS position data, or manually enter your position data.
- If no repeater is found within a 160 kilometers (100 miles) range, “No Repeater Found” is displayed.
- If the last received position data can be used, “GPS is invalid. Search by last valid position” is displayed.

**Example:** Selecting a nearby repeater from the Near Repeater list.

#### Step 1: Receiving your own location from the GPS satellite

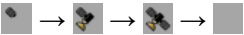
Confirm the GPS receiver is receiving the satellite signals.

- The GPS icon blinks when searching for satellites.  

- The GPS icon stops blinking when the minimum needed number of satellites is found.  

- ① It may take only a few seconds to receive, or it may take a few minutes, depending on your operating environment. If you have difficulties receiving, we recommend that you try a different location.
- ① If your own location is not being received, the last received position is used for your location.

#### Step 2: Selecting the access repeater from the Near Repeater list

1. Hold down [DR] for 1 second to display the DR screen.
2. Push D-pad(↓) to select “FROM,” and then push [ENT].



3. Select “Near Repeater.”

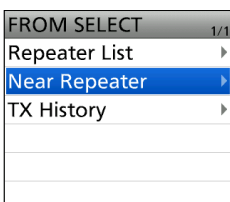

4. Select the type of nearby repeater to display.



- **Near Repeater (ALL):**  
Displays up to 20 nearby DV and FM repeaters. (A total 40 repeaters)
- **Near Repeater (DV):**  
Displays up to 20 nearby DV repeaters.
- **Near Repeater (FM):**  
Displays up to 20 nearby FM repeaters.

5. Select the repeater to use as your access repeater, considering the distance from your location to the repeater.

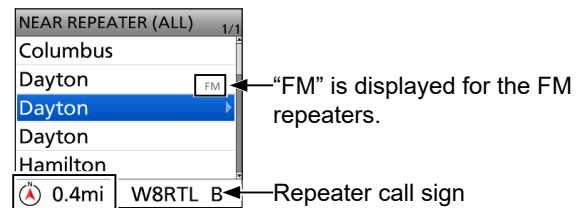

Distance and direction from your location to the repeater\*

- \* When the “POSITION” setting (p. 5-34) is set to “Approximate” on the repeater list, the direction data is not displayed if the distance to the repeater is less than 5 kilometers.
- Returns to the DR screen and the selected repeater is set in “FROM.”



# 5 D-STAR OPERATION (ADVANCED)

## “FROM” (access repeater) setting

### ◇ Using TX History

The TX History saves up to 10 of the latest access (From) repeaters you transmitted on. You can select a repeater from TX History as your access repeater.

**Example:** Selecting the “Hirano” repeater from TX History.

1. Hold down [DR] for 1 second to display the DR screen.
2. Push D-pad(↓) to select “FROM,” and then push [ENT].

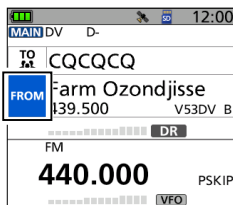

3. Select “TX History.”

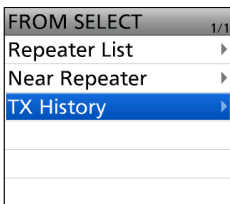

4. Select the TX History (DV) or TX History (FM).

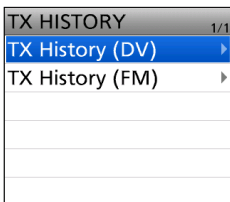

- **TX History (DV):** Displays the TX History of the DV repeaters.
- **TX History (FM):** Displays the TX History of the FM repeaters.

5. Select the repeater to use it as your access repeater.

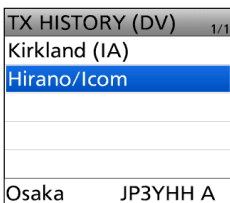

- Returns to the DR screen and the selected repeater is set in “FROM.”



**TIP:** When you push [QUICK] in step 5, you can display the REPEATER DETAIL screen or delete the TX HISTORY screen's repeater information.

## “TO” (Destination) setting

“CQCQCQ,” the destination repeater, or station call sign must be set in “TO” when you make a DV mode call. You have 9 ways to set the destination.

**TIP:** After you receive the individual station or repeater’s signal, the call sign can be captured by holding down the Call Sign Capture key ([RX→CS]), and you can quickly and easily reply to a call.

**By rotating [DIAL]**

Rotate [DIAL] to select the repeater or Your Call Sign displayed on the DR screen. (This operation is disabled when “CQCQCQ” is set.)

**To make a Local Area CQ call**

Set “CQCQCQ” in “TO” (Destination). (p. 5-9)

**To make a Gateway CQ call**

Select a repeater from the Repeater List, if you want to make a Gateway call. (p. 5-9)

**To make a call to a specific station**

Select the station call sign in the Your Call Sign list. (p. 5-10)

**To make a call through a Reflector**

Select a reflector you want to call through. (p. 5-14)

**To select from RX History**

When you receive a call, repeater or caller station data is saved in RX History. Select the destination from the record. (p. 5-10)

**To select from TX History**

When you make a call, the destination repeater or called station data is saved in TX History. Select the destination from the record. (p. 5-11)

**To directly enter the destination station call sign**

Directly enter the destination station’s call sign. (p. 5-11)

**To directly enter the destination repeater call sign**

Directly enter the destination repeater’s call sign. (p. 5-12)

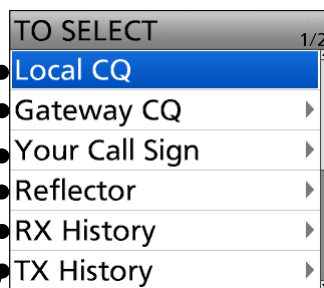

**TIP: How to change the repeater group:**

When “Local CQ” or “Gateway CQ” is selected, you can change the repeater group. To change the repeater group on the DR screen, push [QUICK], then select “Group Select.”

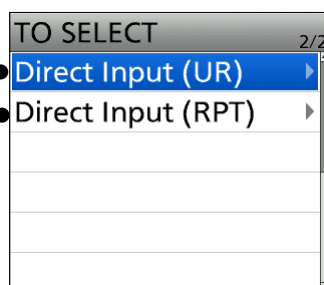
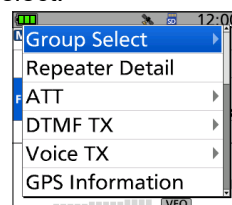

# 5 D-STAR OPERATION (ADVANCED)

## “TO” (Destination) setting

### ◇ Making the “Local CQ” (Local Area call)

When “Local CQ” is selected on the TO SELECT screen, “CQCQCQ” is set in “TO.”

**Example:** Making a Local area call by accessing the “Kirkland (IA)” repeater.

1. Hold down [DR] for 1 second to display the DR screen.
2. Push D-pad(↑) to select “TO,” and then push [ENT].

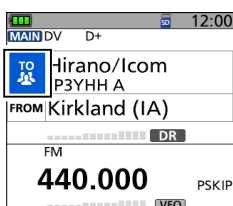

3. Select “Local CQ.”

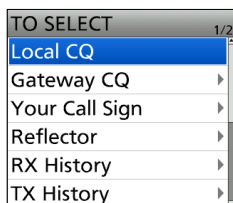

- Returns to the DR screen, and “CQCQCQ” is displayed in “TO.”

### ◇ Making a “Gateway CQ” (Gateway call)

When “Gateway CQ” is selected on the TO SELECT screen, you can select the repeater to make a gateway call to.

**Example:** Making a Gateway CQ call to the “Hirano” repeater from the “Kirkland (IA)” repeater.

1. Hold down [DR] for 1 second to display the DR screen.
2. Push D-pad(↑) to select “TO,” and then push [ENT].



3. Select “Gateway CQ.”

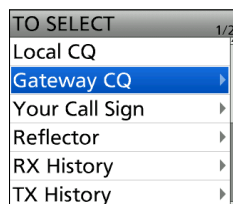

4. Select the repeater group where your destination repeater is listed.



5. Select the destination repeater.

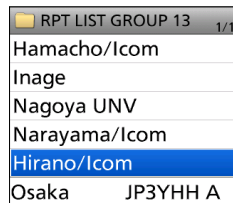

- ① Each repeater has a correct node (A, B, or C band) that you want to transmit on. See page 5-2, “IMPORTANT” for band letter details.

- Returns to the DR screen, and the selected repeater name is displayed in “TO.”

**TIP:** After selecting a destination repeater, you can select another repeater preset in your repeater List by rotating [DIAL].

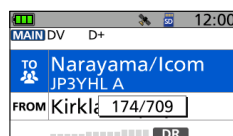

## 5 D-STAR OPERATION (ADVANCED)

### “TO” (Destination) setting

#### ◇ Using “Your Call Sign”

The “Your Call Sign” memory saves individual or repeater station call signs. When you select the call sign for the “TO” (Destination) setting, you can make a Gateway call. When you call an individual station through a gateway, the signal is automatically sent to the last repeater that the individual station accessed. Therefore, even if you do not know where the individual station is located, you can make a call.

**NOTE:** If the repeater, set in “FROM” (access repeater), has no Gateway call sign, you cannot make a gateway call.

**Example:** Selecting “Rick” from “Your Call Sign.”

1. Hold down [DR] for 1 second to display the DR screen.
2. Push D-pad(↑) to select “TO,” and then push [ENT].



3. Select “Your Call Sign.”

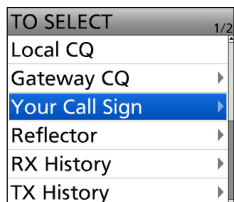

4. Select a destination name or call sign.

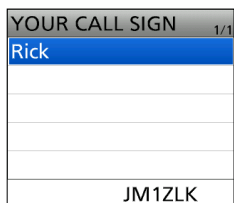

- Returns to the DR screen, and the selected name is displayed in “TO.”

**TIP:** After selecting a destination, you can select another station preset in your transceiver by rotating [DIAL].

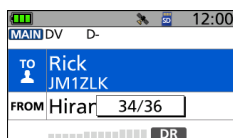

#### ◇ Using RX History

When a call is received in the DV mode, the call data is saved in the RX History. Up to 50 callers, and only the last called call signs, a total of 51 histories can be saved.

**Example:** Selecting “Rick” in the RX History.

1. Hold down [DR] for 1 second to display the DR screen.
2. Push D-pad(↑) to select “TO,” and then push [ENT].

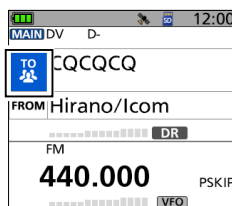

3. Select “RX History.”

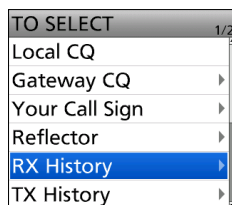

4. Select a destination name or call sign.

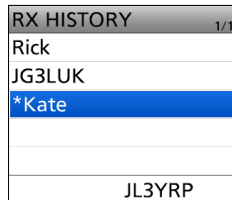

- Returns to the DR screen, and the selected name is displayed in “TO.”
- ① The “\*” (asterisk) is displayed at the beginning of the called station’s call sign. (p. 5-19)

**TIP:** To add an RX HISTORY data to the “Your Call Sign” memory, push [QUICK], then select “Add To Your Memory.”

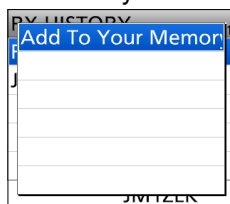

# 5 D-STAR OPERATION (ADVANCED)

## “TO” (Destination) setting

### ◇ Using TX History

TX History saves the repeater and station name and call sign of up to 20 “TO” (Destination) settings used when you made the calls.

**NOTE:** Until you make a call in the DV mode, you cannot select “TO” (destination) from the TX History.

**Example:** Selecting the “Kirkland (IA)” repeater in the TX History.

1. Hold down [DR] for 1 second to display the DR screen.
2. Push D-pad(↑) to select “TO,” and then push [ENT].

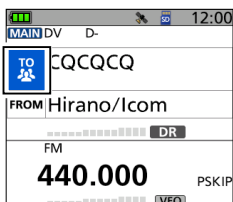

3. Select “TX History.”

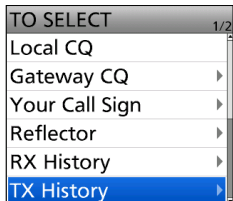

4. Select a destination repeater.

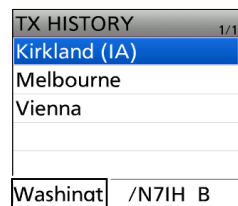

The Sub name is displayed when a repeater is selected.

- Returns to the DR screen, and the selected repeater name is displayed in “TO.”

**TIP:** You can add the TX HISTORY data to memory, or delete it from the TX HISTORY screen. Push [QUICK], then select the option.

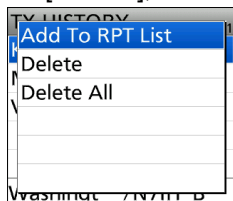

### ◇ Directly entering (UR)

The destination station call sign can be directly entered.

**Example:** Directly entering the call sign “JM1ZLK.”

1. Hold down [DR] for 1 second to display the DR screen.
2. Push D-pad(↑) to select “TO,” and then push [ENT].

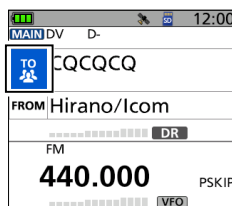

3. Select “Direct Input (UR).”

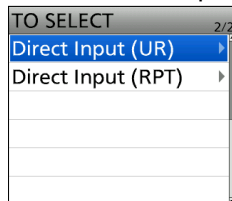

4. Enter a call sign of up to 8 characters, including spaces.



① See page iii on how to enter characters.

5. After entering, push [ENT].

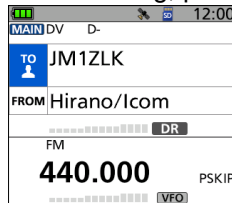

- Returns to the DR screen and the entered call sign is displayed in “TO.”

① After entry, you can edit the call sign in the DIRECT INPUT (UR) screen.

① The entered call sign remains on the DIRECT INPUT (UR) screen until you enter a new call sign.

**TIP:** If the entered call sign is duplicated in the “Your Call Sign” memory, the name is displayed. (Only when the name has been entered.)

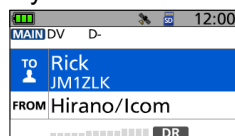

## 5 D-STAR OPERATION (ADVANCED)

### “TO” (Destination) setting

#### ◇ Directly entering (RPT)

The destination repeater call sign can be directly entered.

**NOTE: BE SURE** to include a node letter as the 8th digit. See page 5-2 “IMPORTANT” about the node letters.

**Example:** Directly entering the call sign “JP3YDH A.”

1. Hold down [DR] for 1 second to display the DR screen.
2. Push D-pad(↑) to select “TO,” and then push [ENT].

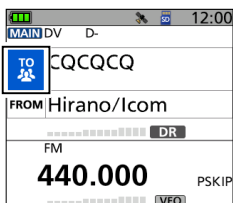

3. Select “Direct Input (RPT).”

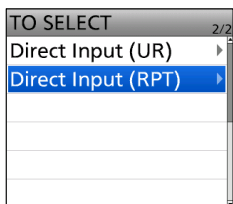

4. Enter a call sign of up to 8 characters, including spaces.

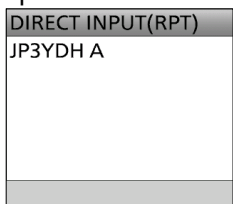

5. After entering, push [ENT].
    - Returns to the DR screen and “JP3YDH A” is displayed in “TO.”
- ① After entry, you can edit the call sign in the DIRECT INPUT (RPT) screen.
- ① The entered call sign remains on the DIRECT INPUT (RPT) screen until you enter a new call sign.

#### TIP:

- If the entered call sign is duplicated in the repeater list, the name is displayed in “TO” (Only when the name has been entered).
- When directly entering the repeater call sign, including a “/” at the beginning is also correct.

## REPEATER DETAIL screen

Depending on the content, such as position data or UTC offset, the distance between your location and the repeater, or the repeater time can be displayed on the REPEATER DETAIL screen.

The detail screen can also be entered from the FROM SELECT screen.

**Example:** Displaying the “Hirano/Icom” repeater detail screen

1. Hold down [DR] for 1 second to display the DR screen.
2. Push D-pad(↑) to select “TO” then push [ENT].



3. Select “Gateway CQ.”

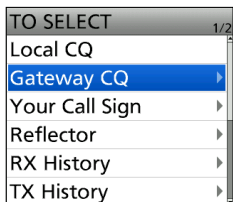

4. Select “13: Japan.”



5. Select “Hirano/Icom.”  
① **DO NOT** push [ENT].

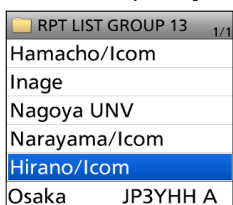

6. Push [QUICK].
7. Select “Detail.”

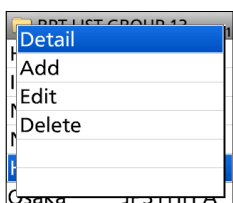

8. Push [ENT].  
• Returns to the previous screen.

### The REPEATER DETAIL screen

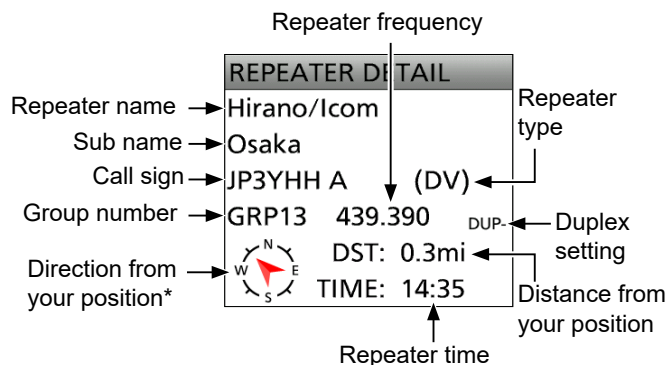

\* When the “POSITION” setting (p. 5-34) is set to “Approximate” on the repeater list, the direction data is not displayed if the distance to the repeater is less than 5 kilometers.

- ① If there is no position data, the distance and direction from your position are not displayed. See page 6-3 to confirm your position.
- ① When selecting an FM repeater, either of “FM” or “FM-N” and the tone setting are displayed.

**TIP:** You can display the REPEATER DETAIL screen when the DR screen is displayed.

When you set the repeater as shown below, push [QUICK], then select “Repeater Detail.”

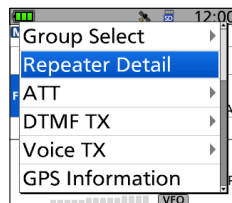
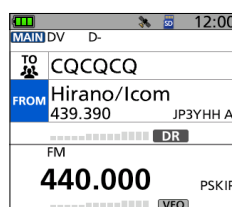

- The REPEATER DETAIL screen is displayed.

## Connecting to a reflector

### ◇ What is a reflector?

A reflector is a special server connected to the Internet and running a version of the D-Plus software. If the D-Plus software is installed on your access repeater, it provides various functions including gateway and reflector linking capabilities (It is known as the D-STAR reflector system). The D-STAR reflector system enables a number of D-STAR repeaters anywhere to link to a reflector. This means that when you transmit through a D-STAR repeater linked to a reflector, your voice can be heard on other repeaters linked to the reflector, and you can hear other stations that are connected to the reflector.

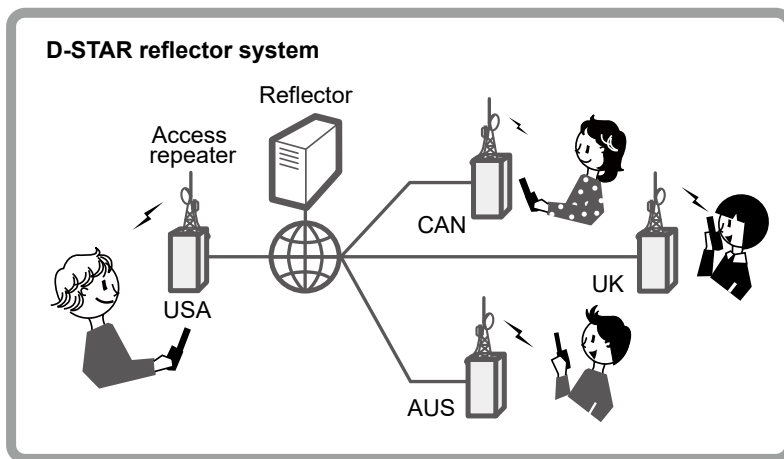

### ◇ Unlinking a reflector

Before trying to link to another reflector, **BE SURE** to unlink the currently connected to the repeater.

**NOTE:** If a reflector is already connected, ask on the air whether or not you can change reflectors and wait for responses. **BE SURE** to reconnect back to the same reflector when you finish your conversation.

1. Hold down [DR] for 1 second to display the DR screen.
2. Push D-pad(t) to select "TO," and then push [ENT].
  - Displays the TO SELECT screen.
3. Select "Reflector."

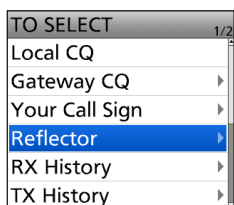

- Displays the REFLECTOR screen.

4. Select "Unlink Reflector."

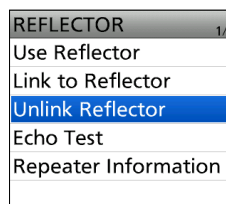

- Returns to the DR screen, and "Unlink Reflector" and "U" are displayed in "TO."



5. Hold down [PTT] to unlink the reflector.
  - The TX/RX indicator lights red.

# 5 D-STAR OPERATION (ADVANCED)

## Connecting to a reflector

### ◇ Linking to a reflector

If your repeater is not currently linked to a reflector, or if you want to change it to another reflector, follow the steps below. Before linking to another reflector, **BE SURE** to unlink the current reflector. (p. 5-14)

#### Direct inputting a reflector

**Example:** Directly enter “REF030CL.”

1. Push D-pad(t) to select “TO,” and then push [ENT].



2. Select “Reflector.”

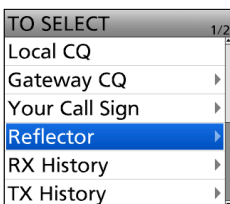

3. Select “Link to Reflector.”

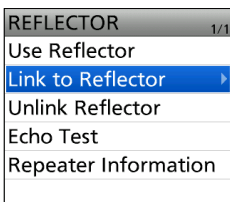

4. Select “Direct Input.”

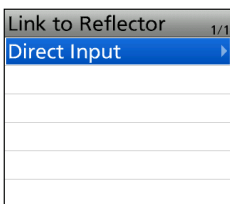

5. Push D-pad to move the cursor, and select the reflector type, reflector number, or module letter.

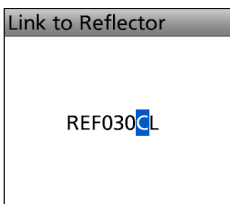

6. Push [ENT].



- Returns to the DR screen, and “Link to Reflector” and “REF030CL” are displayed in “TO.”

7. Hold down [PTT] to link to the Reflector.

### Using TX History

TX History saves up to 5 reflectors that your access repeater linked to before.

**Example:** Select “REF030CL” in TX History.

1. Push D-pad(t) to select “TO” then push [ENT].

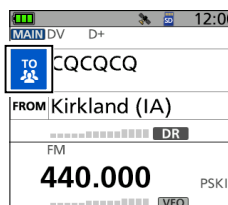

- The TO SELECT screen is displayed.
2. Select “Reflector.”
  3. Select “Link to Reflector.”
  4. Select the Reflector that you want to link to.

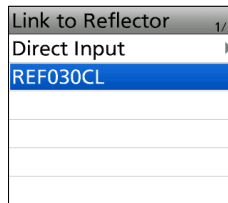

- Returns to the DR screen, and “Link to Reflector” and “REF030CL” are displayed in “TO.”



5. Hold down [PTT] to link to the Reflector.

## 5 D-STAR OPERATION (ADVANCED)

### Connecting to a reflector

#### ◇ Using a reflector

1. Push D-pad(↑) to select “TO,” and then push [ENT].
  - The TO SELECT screen is displayed.
2. Select “Reflector.”  
The REFLECTOR screen is displayed.
3. Select “Use Reflector.”

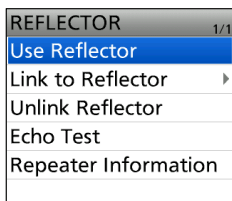

- Returns to the DR screen, and “Use Reflector” and “CQCQCQ” are displayed in “TO.”



4. Hold down [PTT] to transmit.

#### ◇ Reflector Echo testing

To confirm that your signal is correctly getting into the repeater, you can transmit a short message as a trial. After releasing [PTT], your message will be played back.

1. Push D-pad(↑) to select “TO,” and then push [ENT].
  - The TO SELECT screen is displayed.
2. Select “Reflector.”  
The REFLECTOR screen is displayed.
3. Select “Echo Test.”

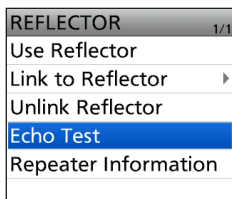

- Returns to the DR screen, and “Echo Test” and “E” are displayed in “TO.”



4. Hold down [PTT] and speak into the microphone.
5. Release [PTT] to hear your message.

#### ◇ Requesting repeater information

When you send the repeater information command, an ID message is sent back.

1. Push D-pad(↑) to select “TO,” and then push [ENT].
  - The TO SELECT screen is displayed.
2. Select “Reflector.”
  - The REFLECTOR screen is displayed.
3. Select “Repeater Information.”

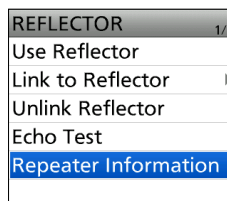

- Returns to the DR screen, and “Repeater Information” and “I” are displayed in “TO.”



4. Hold down [PTT] to transmit the repeater Information command.
5. Release [PTT] to hear the repeater ID message.

## Message operation

You can save up to 5 short messages in the transceiver's memory to transmit in the DV mode. Each message can be up to 20 characters.

### ◇ Entering a TX message

[MENU] > SET > My Station > TX Message

**Example:** Entering "JAPAN TOM" into TX message memory number 1.

1. Push [MENU].
2. Select "My Station" in the "SET" menu.

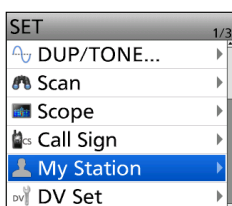

3. Select "TX Message."

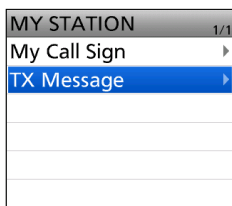

4. Select a TX Message memory number.

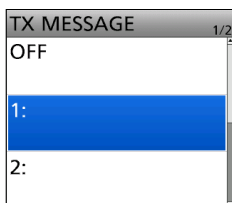

① **DO NOT** push [ENT].

5. Push [QUICK].
6. Select "Edit."

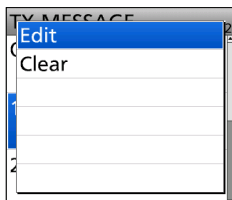

7. Enter a message of up to 20 characters.

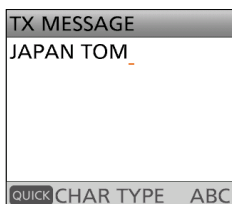

① See page iii on how to enter characters.

8. After entering, push [ENT].
  - Returns to the TX MESSAGE screen.

### ◇ Transmitting a message

You can transmit a preset TX message by pushing [PTT] in the DV mode. First, select a TX message which also turns ON the Message Transmission function.

[MENU] > SET > My Station > TX Message

1. Push [MENU].
2. Select "My Station" in the "SET" menu.

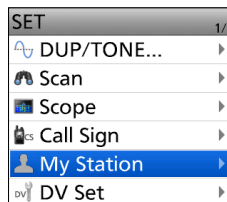

3. Select "TX Message."

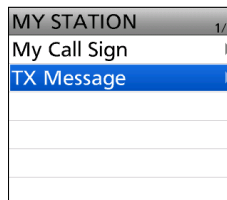

4. Select a TX Message memory number.

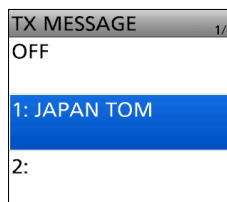

① To not transmit any message, select "OFF."

① To exit the MENU screen, push [MENU].

#### ① Information

- The message is transmitted with your voice signal.
- The message is transmitted each time you push [PTT].
- When continuously transmitting, the selected TX message is transmitted every 30 seconds.

#### TIP: RX call sign and message display

As the default, the received call sign and message are automatically displayed and scrolled.

To not display and scroll them, set RX Call Sign to "OFF."

([MENU] > SET > Display > RX Call Sign)

# 5 D-STAR OPERATION (ADVANCED)

## Message operation

### ◇ Deleting a TX message

[MENU] > SET > My Station > TX Message

**Example:** Deleting the entered TX message “JAPAN TOM” from TX message memory number 1.

1. Push [MENU].
2. Select “My Station” in the “SET” menu.

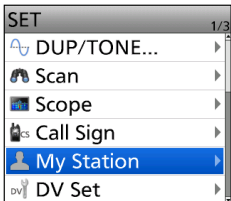

3. Select “TX Message.”

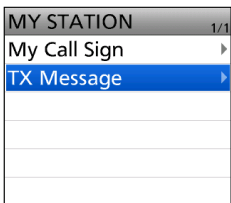

4. Select a TX Message memory number.

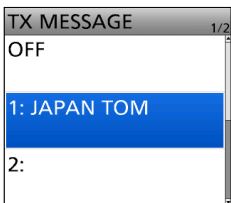

① **DO NOT** push [ENT].

5. Push [QUICK].
6. Select “Clear.”

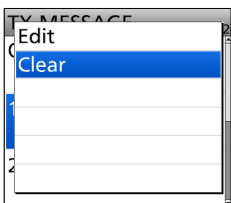

• The confirmation dialog is displayed.

7. Select “YES.”

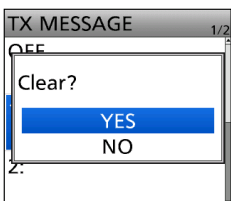

• The entered message is cleared.

① To exit the MENU screen, push [MENU].

## Viewing received call signs

When you receive a DV call, the calling station and the repeater call signs are saved. Up to 50 calls can be saved. When you receive the 51st call, the oldest call history is deleted.

① Even if the transceiver is turned OFF, the RX records are not deleted.

### ◇ Viewing the call signs on the RX History screen

1. Hold down [CD] for 1 second.
2. Select an RX history memory to view the details.

#### ① Information

- The first page of the "RX HISTORY" screen displays the latest RX record of the MAIN band. The second page or later displays the record according to the received date and time, regardless of the band it was received on.
- The RX history number, the caller's name (or call sign), destination, RX message, RX date and time, "GW," and "GPS" are displayed.
- "GW" is displayed when the Gateway call is received.
- "GPS" is displayed when the received call includes position data.
- "UP" is displayed when the repeater uplink signal is received.
- In the Quick Menu window, you can select the following options.

**RX>CS:** Temporarily enters the received call sign into "TO."

**Call Sign Display:** The received data is displayed in the Call Sign Display mode.

**Name Display:** The received data is displayed in the Name Display mode.

**Delete:** Deletes the selected RX history.

**Delete All:** Deletes all RX history.

#### RX HISTORY screen (RX01)

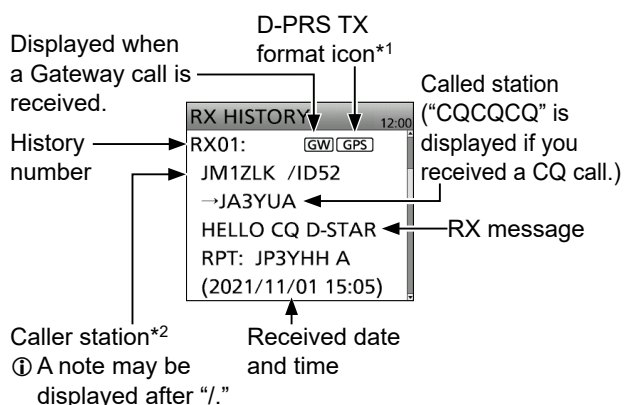

\*1 The displayed icon differs, depending on the D-PRS TX format.

GPS: Position    OBJ: Object  
ITEM: Item      WX: Weather

\*2 When a name is entered in the MEMORY, the name is also displayed.

3. Push [ENT].
    - Displays the RX history detail screen.
- ① Push D-pad(↑) to view the content.

#### <1st page>

• **CALLER:** Displays the caller station's call sign\*2, and any note entered after the call sign.

• **CALLED:** Displays the called station's call sign\*2.

① "CQCQCQ" is displayed when receiving a Local Area call or Gateway call.

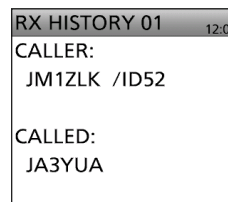

#### <2nd page>

• **RX RPT1:** Displays the repeater's call sign\*2 that was accessed by the caller station.

If the received call was a Gateway call, this item displays the gateway call sign of the repeater you received the call from.

• **RX RPT2:** Displays the repeater's call sign\*2 you received the call from.

① The operating frequency is displayed instead of the above items when the call was not through a repeater (Simplex call).

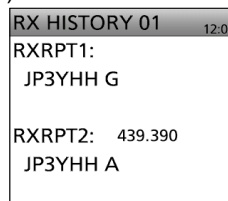

# 5 D-STAR OPERATION (ADVANCED)

## Viewing the received call signs

◇ View the call signs on the RX History screen

<3rd page>

- **RX MESSAGE:** Displays any message included in the received call if entered.
- **RX TIME:** Displays the date and time the call was received.



<4 ~ 6th page>

Displays position data of the caller station. If a received signal has no data, then no position data is displayed.

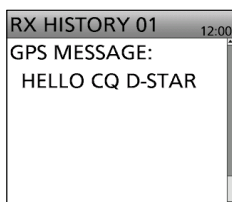
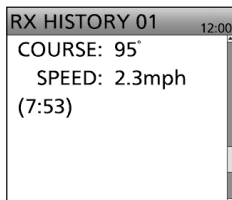

**TIP: To delete RX HISTORY data**

On the RX HISTORY or the detail screen, push [QUICK], then select “Delete” or “Delete All.”

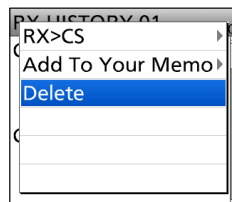

**TIP: “RX RPT1” setting may differ, depending on the way the call was made.**

**Example 1: When a Local area call is received.**

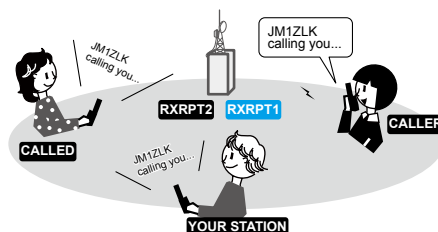

**Example 2: When a Gateway call is received.**

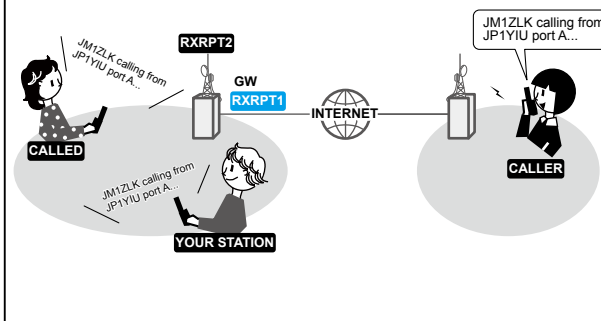

① To exit the MENU screen, push [MENU].

## BK mode communication

The Break-in (BK) function enables you to break into a conversation, where the 2 stations are communicating with Digital Call Sign squelch (DSQL) enabled.

① The BK function is automatically turned OFF when you turn OFF the transceiver.

[MENU] > SET > DV Set > **BK**

- While 2 stations are communicating in the DV mode, hold down [RX→CS] for 1 second.
  - After releasing [RX→CS], the calling station's call sign or the repeater's call sign is set to "TO" (Destination).
  - Beeps sound, and the calling station's call sign is announced.
- Push [MENU].
- Select "DV Set" in the SET menu.

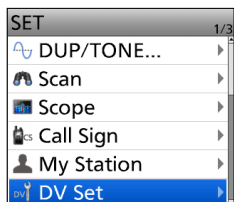

- Select "BK."

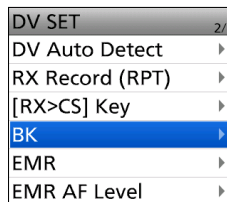

- Select "ON."

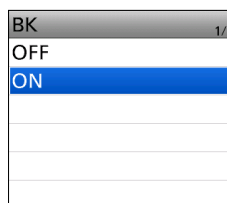

- Push [MENU].

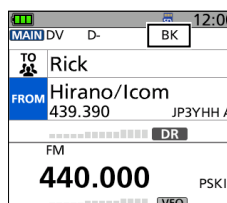

- Returns to the Standby screen and "BK" is displayed.
- When both stations are in standby, push [PTT] to transmit.
    - "BK" blinks when receiving a Break-in call.
    - To cancel the BK mode, select "OFF" in step 5, or turn OFF the transceiver.

### How to use Break-in?

While using the Digital Call Sign squelch (DSQL), the squelch never opens (no audio is heard) even if a call is received, unless the call is addressed to your call sign.

However, when a call including the "BK ON" signal (break-in call) is received, the squelch opens, and audio is heard even if the call is addressed to another station.

#### Station C calling to Station A with "BK OFF"

Station A and B are communicating using the Digital Call Sign squelch.

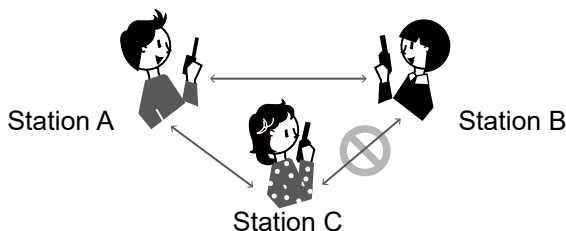

Station B does not hear that Station C is calling Station A.

#### Station C calling to Station A with "BK ON"

Station A and B are communicating using the Digital Call Sign squelch.

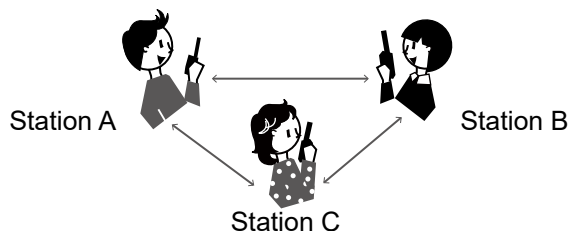

Station B also hears that Station C is calling Station A.

## EMR communication

The Enhanced Monitor Request (EMR) communication function can be used in only the DV mode. Using the EMR function, no call sign setting is necessary.

### Information

- All transceivers that can receive an EMR signal automatically receive the signal. **DO NOT** use this function except in the case of an emergency.
- When an EMR signal is received, the audio (voice) is heard at the set level, even if the volume setting level is set to the minimum level.
- The EMR communication function is automatically turned OFF when you turn OFF the transceiver.

[MENU] > SET > DV Set > EMR

**Example:** Transmitting from the “Hirano” repeater using the EMR function.

1. Push [MENU].
2. Select “DV Set” in the “SET” menu.

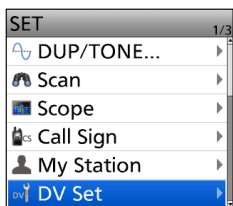

3. Select “EMR.”

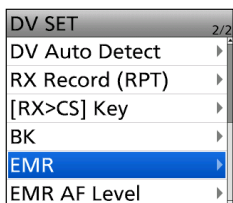

4. Select “ON.”



5. Push [MENU].

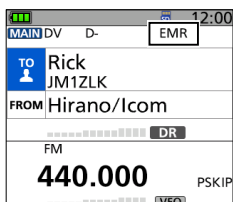

- Returns to the Standby screen and “EMR” is displayed. Push [PTT].
- The TX/RX indicator lights red while transmitting.
- ① “EMR” blinks on a station that receives the EMR signal. The audio (voice) is heard at the set level, or the [VOL] level, whichever is higher.
- ① To cancel the EMR mode, select “OFF” in step 4, or turn OFF the transceiver.

### Adjusting the EMR AF level

The audio output level when an EMR signal is received is adjustable between 0 and 39.

When an EMR signal is received, the audio is heard at the preset level, or the [VOL] control level, whichever is higher.

To turn OFF the setting, set to “0.”

[MENU] > SET > DV Set > EMR AF Level

1. Push [MENU].
2. Select “DV Set” in the “SET” menu.

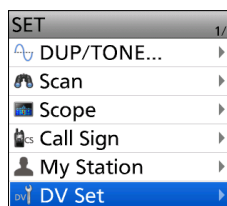

3. Select “EMR AF Level.”

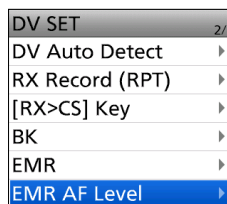

4. Rotate [DIAL] to adjust the EMR audio output level between 0 (OFF) and 39 (maximum). (Default: 19)

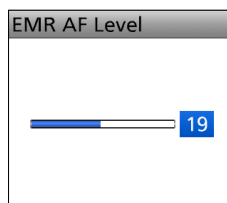

① To exit the MENU screen, push [MENU].

## Automatic DV detection

If you receive an FM signal while in the DV mode, the “DV” and “FM” icons alternately blink to indicate the received signal is FM.

When the DV Auto Detect function is ON, the transceiver automatically selects the FM mode to monitor it temporarily. (Default: OFF)

① Regardless of this setting, the “DV” and “FM” icons alternately blink if you receive an FM signal while in the DV mode.

**NOTE:** When Digital Call Sign squelch (DSQL), or Digital Code squelch (CSQL) is selected, the transceiver does not receive FM signals, even if this function is ON. You can silently wait for calls from others.

### [MENU] > SET > DV Set > DV Auto Detect

1. Push [MENU].
2. Select “DV Set” in the “SET” menu.

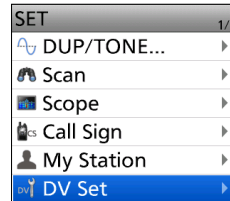

3. Select “DV Auto Detect.”

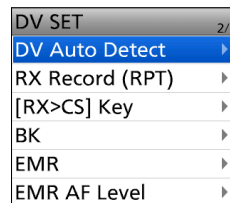

4. Select “ON.”

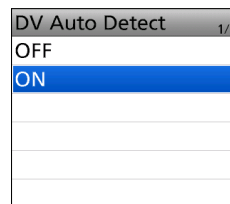

① To exit the MENU screen, push [MENU].

① When an FM signal is received while in the DV mode, the “DV” and “FM” icons sequentially blink, and the transceiver receives the signal in the FM mode.

### When an FM signal is received while in the DV mode

#### DV Auto Detect function: OFF

The “DV” and “FM” icons alternately blink, but the audio cannot be heard.

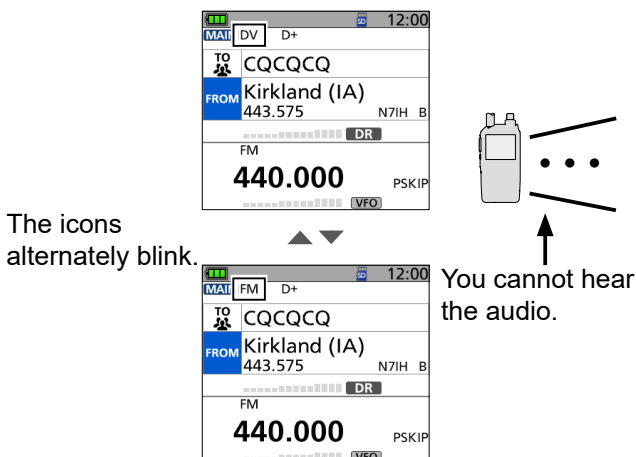

#### DV Auto Detect function: ON

The “DV” and “FM” icons alternately blink, and the audio can be heard.

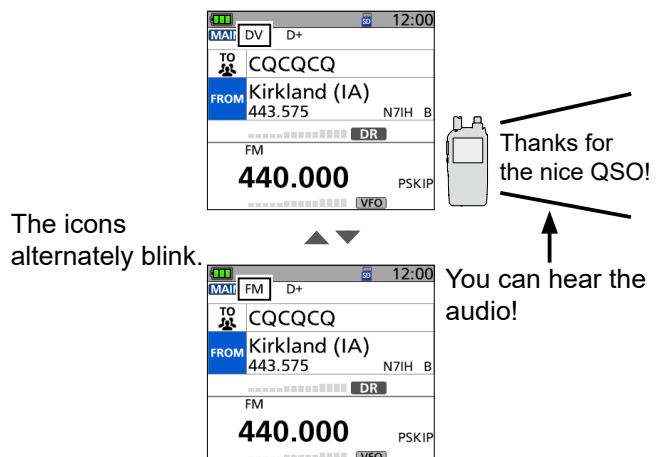

## Automatic Reply function

When a call addressed to your call sign is received, the Automatic Reply function sounds beeps and automatically replies with your call sign.

(Default: OFF)

Depending on the setting, a recorded message may be transmitted with the call sign.

**NOTE:** The Automatic Reply function temporarily sets the received call sign to "TO" (destination).

**TIP: To record the Auto Reply message**

You can record the Auto Reply message. See page 5-25 for details.

([MENU] > RECORD > DV Auto Replay)

[MENU] > SET > DV Set > **Auto Reply**

1. Push [MENU].
2. Select "DV Set" in the "SET" menu.

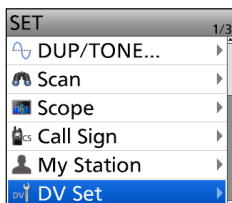

3. Select "Auto Reply."

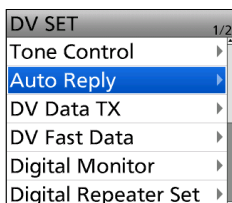

4. Select an option.

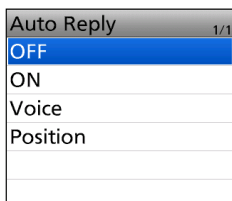

- **ON:** Automatically replies with your own call sign. (No audio reply is sent)
- **Voice:** Automatically replies with your own call sign and an Auto Reply message recorded on the microSD card (up to 10 seconds).
  - ① If no SD card is inserted, or no message is recorded, replies with only your own call sign (No audio reply is sent).
- **Position:** Automatically replies with your call sign and your position data using the internal GPS receiver.
  - ① When "GPS Select" is set to "OFF" or "Manual," the internal GPS receiver is temporarily turned ON.

5. Push [MENU].
  - Returns to the Standby screen, and displays "A" with a signal strength indicator.
  - ① When "ON" or "Voice" is selected, the Automatic Reply function is automatically turned OFF when you push [PTT].
  - When "Position" is selected, the Automatic Reply function remains ON, when you push [PTT].

**Example:** After receiving a call from "JM1ZLK," beeps sound, and the transceiver automatically sends a reply call.



The "TO" setting does not change, but "UR: JM1ZLK (Caller's call sign)" is displayed.

## 5 D-STAR OPERATION (ADVANCED)

### Automatic Reply function

#### ◇ Recording an Auto Reply message

You can record the Auto Reply message that is saved on a microSD card to reply to the call with your voice.

**NOTE:** Confirm a microSD card is in the card slot.

[MENU] > RECORD > DV Auto Reply

1. Push [MENU].
2. Select “DV Auto Reply” in the RECORD menu.

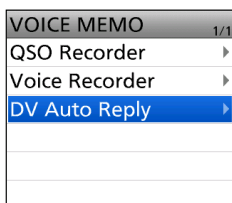

3. Hold down [PTT] to start a recording, release it to stop recording.

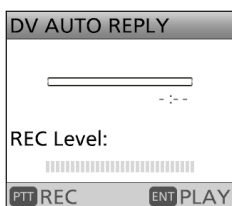

#### ① Information

- The maximum recording time is 10 seconds.
  - Hold the microphone 5 ~ 10 cm (2 ~ 4 inches) from your mouth, then speak at your normal voice level.
  - Only 1 message can be recorded. The current contents are overwritten if you record again.
4. To exit the MENU screen, push [MENU] twice.

#### The DV AUTO REPLY screen

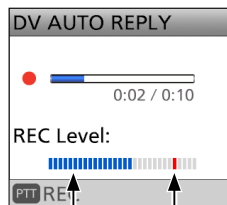

Audio level is displayed

Adjust the Mic gain so that the REC Level does not reach to this range ([MENU] > SET > Function > MIC Gain (Internal), MIC Gain (External))

**TIP:** To delete the recorded message, push [QUICK] on the DV AUTO REPLY screen, then select “Clear.”

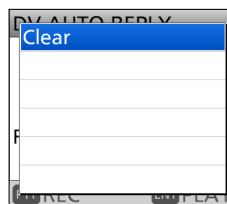

# 5 D-STAR OPERATION (ADVANCED)

## Automatic Reply function

### ◆ Auto Position Reply function

When you receive a call addressed to your call sign, but are in a situation that makes it difficult to operate the transceiver, this function sounds beeps and automatically replies with your call sign and transmits your position data.

After receiving the Auto Position Reply call, the caller's position data is displayed in a window.

- ① Icom transceivers\* display the position after receiving a call.
- ② You can turn OFF the caller's position display. (p. 12-26) ([MENU] > SET > Display > **Reply Position Display**)

\* Except for the ID-31A/E, IC-9100, ID-880H/E880, IC-80AD/E80D, IC-92AD/E92D, IC-2820H/E2820, ID-800H, IC-91AD/E91, IC-V82, IC-U82



- 3. After receiving, the position data is displayed on the destination's transceiver.

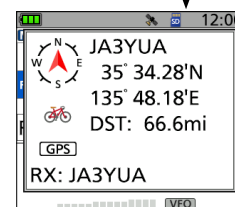

Scrolls your call sign or the TX message.  
 ① Your status message may be displayed.

### When no valid position data is received

After receiving a call addressed to your call sign, the internal GPS receiver is temporarily turned ON for approximately 5 minutes to receive your position data, even if "GPS Select" is set to "OFF" or "Manual." Then, the transceiver automatically replies with a message, as described below.

([MENU] > GPS > GPS Set > **GPS Select**)

- ① When the internal GPS receiver is temporarily ON, and valid position data is received, the transceiver transmits your position data if a call addressed to your call sign is received again.

### Reply message list when no valid position data is received

| Message              | Status   |
|----------------------|--|
| No Position          | When no position data is received.   |
| Old Position         | 2 minutes or more has passed since receiving position data.  |
| No Posi & GPS Start  | The internal GPS receiver is temporarily turned ON but has not received your position data yet.                      |
| Old Posi & GPS Start | The internal GPS receiver is temporarily turned ON, and 2 minutes or more have passed since receiving position data. |



#### TIP:

- The position data is transmitted according to the "GPS TX Mode." (p. 6-12)
- When the "GPS TX Mode" settings are incorrect for the Automatic Reply function, the transceiver automatically corrects them to reply to a call.
- When "GPS TX Mode" is set to "OFF," "D-PRS" is automatically selected.

## Data communication

In addition to digital voice communication, you can send and receive data. Also, you can use the DV Fast Data function for data communication (p. 5-28). To send and receive data, a USB cable (purchase separately or user supplied), and a data communication software (user supplied) are required.

**NOTE:** “DV Data TX” is set to “Auto” as the default setting. When you enter text data into your communication software, the transceiver may automatically transmit it, depending on the software and the software settings.

### ◇ Connection

Connect the transceiver to your PC using a USB cable, as shown below.

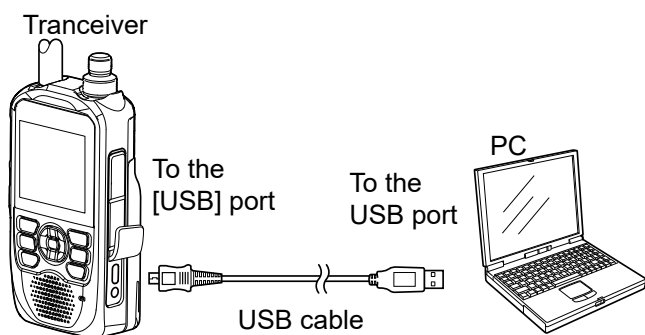

**NOTE:** Before you start sending data, **BE SURE** to set the following items.

- Set “GPS Out (USB Port)” to “OFF ”  
([MENU] > GPS > GPS Set > **GPS Out (USB Port)**)
- Set “USB Connect” to “Serialport,”  
([MENU] > SET > Function > **USB Connect**)
- Set “USB Serialport Function” to “DV Data.”  
([MENU] > SET > Function > **USB Serialport Function**)

### ◇ Data communication application setting

Set the communication software, as shown below.

- Port: The COM port number that is used by the ID-52A/E \*
- Baud rate: Your desired speed
- Data: 8 bit
- Parity: none
- Stop: 1 bit
- Flow control: Xon/Xoff

\* Depending on the PC environment, the COM port number used by the ID-52A/E may be higher than 5. In that case, use an application that can set it to higher than 5.

### ◇ Sending data

1. Set your call sign, the destination call sign, and the repeater call sign.
2. Follow the instructions of your data communication application software.
3. When you enter text data into your communication software, the transceiver may automatically transmit it, depending on the software and its settings.
  - ① When “DV Data TX” is set to “PTT,” pushing [PTT] transmits the text data and a voice signal. (p. 12-10) ([MENU] > SET > DV Set > **DV Data TX**)
  - ② Before transmitting the data, the transceiver sends a carrier sense signal approximately 500 milliseconds.

#### **NOTE:**

- Only ASCII code can be used for data communication.
- The transceiver also has the Message Transmission function that transmits up to 20 characters. (p. 5-17)
- Depending on the combination of your PC and your communication software, some data may be lost.
- While receiving voice or data through the Internet, some packets may be lost due to network error (poor data throughput performance) In such a case, an “L” is displayed on the screen to indicate that packet loss has occurred.

# 5 D-STAR OPERATION (ADVANCED)

## Data communication

### ◇ DV Fast Data function

To send data using the DV Fast Data function, follow the instructions below.

① DV Fast Data communication can be made by only the following Icom transceivers:

(As of November 2021)

- IC-705
- IC-9700
- ID-31A/E PLUS
- ID-4100A/E
- ID-5100A/E\*
- ID-51A/E (PLUS, PLUS2, 50th Anniversary model)
- ID-52A/E

\* Usable only when firmware versions CPU M 1.10, S 1.00, C 1.10, and DSP 1.10 or later are installed.

**NOTE:** If you want to send GPS data to other transceivers that can receive only slow-speed data, set “GPS Data Speed” to “Slow.” (p. 6-4)  
 ([MENU] > SET > DV Set > DV Fast Data > **GPS Data Speed**)

[MENU] > SET > DV Set > DV Fast Data > **Fast Data**

1. Push [MENU]
2. Select “DV Set” in the “SET” menu.

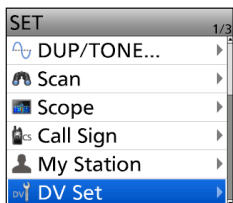

3. Select “DV Fast Data.”

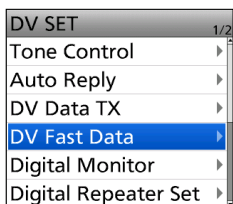

4. Select “Fast Data.”

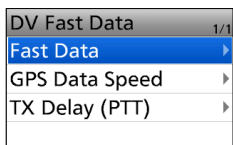

5. Select “ON.”

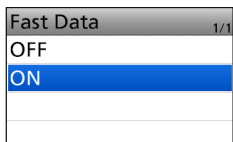

- To exit the MENU screen, push [MENU].

## About the display type

You can enlarge the characters, such as the repeater name displayed by the DR function.

① This setting can be used only when the Single band display is selected.

1. Display the Main screen that you want to change in the Single band display.

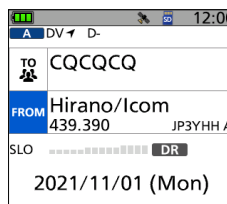

2. Push [QUICK].
3. Select “Display Type.”

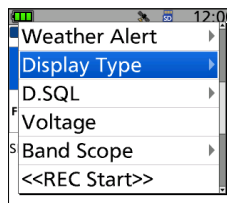

4. Select “Large.”

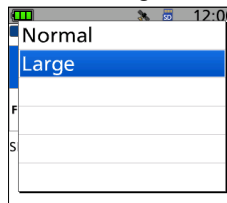

- The characters, such as the repeater name, are displayed larger.

## Digital squelch functions

The digital squelch opens only when you receive a signal addressed to your own call sign or a signal that includes a matching digital code.

You can silently wait for calls from others.

You can independently set the Digital squelch function in the VFO mode, Memory mode, Call channel mode, or DR function.

### ◇ The Digital Call Sign squelch setting

1. Push [QUICK].
2. Select "D.SQL."

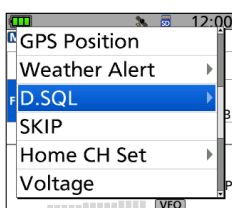

3. Select "DSQL."

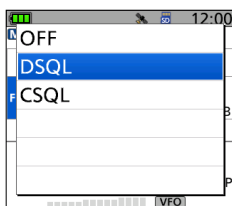

"DSQL" is displayed.

- When the received signal includes a matching call sign, the squelch opens, and you can hear the audio.
- ① When the received signal does not include a matching call sign, the digital call sign squelch does not open. However, the S/Rf meter displays the received signal level.

#### NOTE:

- **DO NOT** use the Digital Call Sign Squelch function when communicating with 2 or more stations, because it opens only when receiving a signal addressed to your call sign. Therefore the function can be used when communicating with only 1 station.
- Even if the squelch is closed by the Digital Call Sign Squelch function, you can receive data in the DV mode.

### ◇ The Digital Code Squelch setting

1. Push [QUICK].
2. Select "D.SQL."

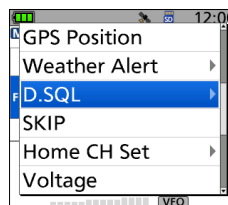

3. Select "CSQL."

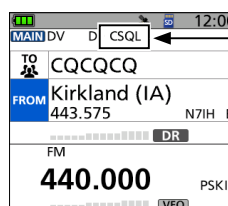
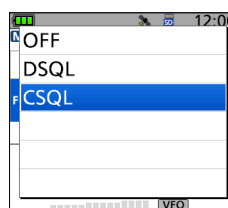

"DSQL" is displayed.

4. Push [MENU].
5. Select "DUP/TONE..." in the "SET" menu.
6. Select "Digital Code."

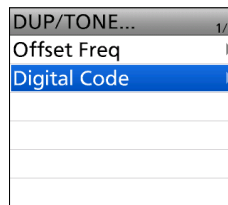

7. Rotate [DIAL] to select a digital code.

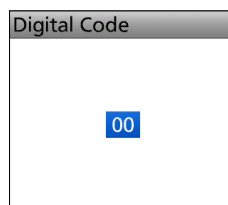

- When the received signal includes a matching code, the squelch opens, and you can hear the audio.
- ① When the received signal does not include a matching code, the digital code squelch does not open. However, the S/Rf meter displays the signal level.
- ② To exit the MENU screen, push [MENU].

**NOTE:** Even if the squelch is closed by the Digital Code Squelch function, you can receive data in the DV mode.

## Repeater list

You can save repeater information for quick and simple communication in up to 2500 repeaters (repeater list) in up to 50 Groups.

Data must be in the repeater list to use the DR function.

You can add and edit repeater content and groups in the repeater list.

You can enter 4 types of frequencies into the repeater list, as shown below:

- DV Repeater
- DV Simplex
- FM Repeater
- FM Simplex

### TIP:

- For easy operation, the repeater list is preloaded into your transceiver. However, if you do an All Reset, the CPU deletes all setting data, the Memory channels, and the repeater list. We recommend that you back up the memory data to a microSD card or save it to a PC using the CS-52 PROGRAMMING SOFTWARE.
- The repeater list can be downloaded from the Icom website. See “Updating the repeater list” that can be downloaded from the Icom website about how to update the repeater list using a microSD card.  
<https://www.icomjapan.com/support/>

### ◇ Repeater list contents

The following contents are included in the repeater list:

- TYPE: Communication type (p. 5-32)
- NAME: Repeater name (p. 5-32)
- SUB NAME: Repeater sub name (p. 5-32)
- CALL SIGN: Repeater call sign and port letter (p. 5-32)
- GW CALL SIGN: Gateway repeater’s call sign and port “G” (p. 5-32)
- GROUP: Repeater group (p. 5-33)
- USE (FROM): access repeater use (p. 5-33)
- FREQUENCY: access repeater’s frequency (p. 5-33)
- DUP: Duplex direction (p. 5-33)
- OFFSET FREQ: Frequency offset (p. 5-33)
- MODE: Operating mode (p. 5-34)
- TONE: Tone setting (p. 5-34)
- REPEATER TONE: Repeater tone (p. 5-34)
- POSITION: Position data accuracy level (p. 5-34)
- LATITUDE: Latitude of the repeater (p. 5-34)
- LONGITUDE: Longitude of the repeater (p. 5-35)
- UTC OFFSET: UTC Offset (p. 5-35)

### Example: “Hirano” repeater information

|               |             |
|---------------|-------------|
| REPEATER LIST | 1/5         |
| TYPE:         | DV Repeater |
| NAME:         | Hirano/Icom |
| SUB NAME:     | Osaka       |

|               |          |
|---------------|----------|
| REPEATER LIST | 2/5      |
| CALL SIGN:    | JP3YHH A |
| GW CALL SIGN: | JP3YHH G |
| GROUP:        | 13 Japan |

|               |            |
|---------------|------------|
| REPEATER LIST | 3/5        |
| USE (FROM):   | YES        |
| FREQUENCY:    | 439.390.00 |
| DUP:          | DUP-       |

|               |             |
|---------------|-------------|
| REPEATER LIST | 4/5         |
| OFFSET FREQ:  | 5.000.00    |
| POSITION:     | Exact       |
| LATITUDE:     | 34° 37.55'N |

|               |              |
|---------------|--------------|
| REPEATER LIST | 5/5          |
| LONGITUDE:    | 135° 34.09'E |
| UTC OFFSET:   | + 9:00       |

## 5 D-STAR OPERATION (ADVANCED)

### Entering new information into the repeater list

This section describes how to manually enter new repeater information into the repeater list.

The required setting items differ, depending on your communication usage. Confirm the required items, as shown below.

**NOTE:** To enter repeater information into the repeater list, the repeater's call sign must be entered first.

#### ◇ Required items for the communication cases

| Repeater list contents | Used as an access repeater                               | Used as a destination repeater   | Used as an FM repeater           | Simplex (FROM)                   |                                  |
|------------------------|--|----------------------------------|----------------------------------|----------------------------------|----------------------------------|
|                        | DV Repeater  | DV Repeater                      | FM Repeater                      | DV Simplex                       | FM Simplex                       |
| TYPE                   |  |                                  |                                  |                                  |                                  |
| NAME                   | <input type="radio"/>                                    | <input type="radio"/>            | <input type="radio"/>            | <input type="radio"/>            | <input type="radio"/>            |
| SUB NAME               | <input type="radio"/>                                    | <input type="radio"/>            | <input type="radio"/>            | <input type="radio"/>            | <input type="radio"/>            |
| CALL SIGN              | <input checked="" type="radio"/>                         | <input checked="" type="radio"/> | <input type="radio"/>            | N/A                              | N/A                              |
| GW CALL SIGN           | <input checked="" type="radio"/><br>(For a Gateway call) | <input checked="" type="radio"/> | N/A                              | N/A                              | N/A                              |
| GROUP                  | <input type="radio"/>                                    | <input type="radio"/>            | <input type="radio"/>            | <input type="radio"/>            | <input type="radio"/>            |
| USE(FROM)              | <input checked="" type="radio"/>                         | <input type="radio"/>            | <input checked="" type="radio"/> | <input checked="" type="radio"/> | <input checked="" type="radio"/> |
| FREQUENCY              | <input checked="" type="radio"/>                         | <input type="radio"/>            | <input checked="" type="radio"/> | <input checked="" type="radio"/> | <input checked="" type="radio"/> |
| DUP                    | <input checked="" type="radio"/>                         | <input type="radio"/>            | <input checked="" type="radio"/> | N/A                              | N/A                              |
| OFFSET FREQ            | <input checked="" type="radio"/>                         | <input type="radio"/>            | <input checked="" type="radio"/> | N/A                              | N/A                              |
| MODE                   | N/A  | N/A                              | <input type="radio"/>            | N/A                              | <input type="radio"/>            |
| TONE                   | N/A  | N/A                              | <input type="radio"/>            | N/A                              | <input type="radio"/>            |
| REPEATER TONE          | N/A  | N/A                              | <input type="radio"/>            | N/A                              | <input type="radio"/>            |
| POSITION               | <input type="radio"/>                                    | <input type="radio"/>            | <input type="radio"/>            | <input type="radio"/>            | <input type="radio"/>            |
| LATITUDE               | <input type="radio"/>                                    | <input type="radio"/>            | <input type="radio"/>            | <input type="radio"/>            | <input type="radio"/>            |
| LONGITUDE              | <input type="radio"/>                                    | <input type="radio"/>            | <input type="radio"/>            | <input type="radio"/>            | <input type="radio"/>            |
| UTC OFFSET             | <input type="radio"/>                                    | <input type="radio"/>            | <input type="radio"/>            | <input type="radio"/>            | <input type="radio"/>            |

- : Must be entered
- : Possible to enter
- N/A: Not Applicable

## Entering new information into the repeater list

### ◇ Entering new information into the repeater list

#### Step 1. Selecting the repeater group

[MENU] > MEMORY > Repeater List

1. Push [MENU].
2. Select "MEMORY" on the second page of the MENU screen.
3. Select "Repeater List."

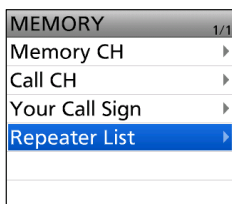

4. Select a repeater group to add a repeater to.



- Displays the repeater list of the selected repeater group.

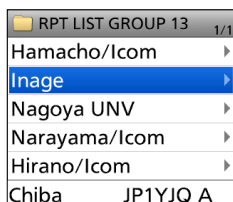

5. Push [QUICK].
6. Select "Add."

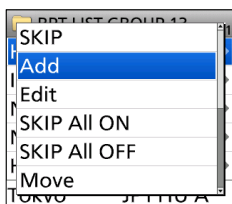

- The REPEATER LIST EDIT screen is displayed.

#### Step 2. Selecting the communication type

1. Select "TYPE."
2. Select the communication type.
  - **DV Repeater:** Repeater operation in the DV mode.
  - **DV Simplex:** Simplex operation in the DV mode.
  - **FM Repeater:** Repeater operation in the FM mode.
  - **FM Simplex:** Simplex operation in the FM mode.

#### Step 3. Entering the repeater name

1. Select "NAME."
2. Enter a name of up to 16 characters.
  - ① See page iii on how to enter characters.
3. After entering, push [ENT].

#### Step 4. Entering the repeater sub name

1. Select "SUB NAME."
2. Enter a sub name of up to 8 characters.
  - ① See page iii on how to enter characters.
3. After entering, push [ENT].

#### Step 5. Entering the repeater call sign

- ① When **Step 2. Selecting the communication type** is set to "DV Simplex" or "FM Simplex," go to **Step 7. Changing the repeater group.**

1. Select "CALL SIGN."
2. Enter the repeater call sign of up to 8 characters, including spaces and the node letter.

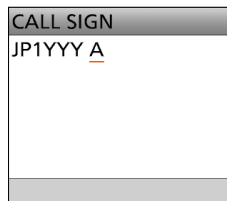

**NOTE: BE SURE** to add the repeater node letter in the 8th digit of the call sign, according to the frequency band shown below. Note that there are almost always different node letters between Japanese D-STAR repeaters and repeaters in other countries.

Cross band operation between different nodes at the same repeater site can be made.

- 1200 MHz: A (B in Japan)
- 430 MHz: B (A in Japan)
- 144 MHz: C (no repeaters in Japan)

3. After entering, push [ENT].

#### Step 6. Entering the gateway repeater call sign

- ① This item is displayed when **Step 2. Selecting the communication type** is set to "DV Repeater."
- ① The 8th digit in the call sign entered in **Step 5. Entering the repeater call sign** is automatically set to "G" as the gateway port, so you can skip this setting and go to the next item.

1. Select "GW CALL SIGN."
2. Enter a gateway repeater call sign of up to 8 characters, including spaces.
  - ① Only a space or "G" can be entered in the 8th digit.

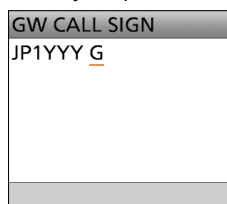

3. After entering, push [ENT].

## 5 D-STAR OPERATION (ADVANCED)

### Entering new information into the repeater list

#### ◇ Entering new information into the repeater list

##### Step 7. Changing the repeater group

① The repeater group that is selected in **Step 1**. **Selecting the repeater group** is displayed. You can skip this setting and go to the next item. To change the group, follow the steps described below.

1. Select "GROUP."
2. Select the repeater group. (01 ~ 50)



##### Step 8. Setting "USE(FROM)" to be used as an access repeater

① You can use the entered repeater as an access repeater when using the DR function. When not using as an access repeater, select "NO," and go to **Step 15. Selecting the position data accuracy level**. In that case, the entered repeater is not displayed in "FROM" on the DR screen.

1. Select "USE(FROM)."
2. Select "YES" to use the repeater as an access repeater.

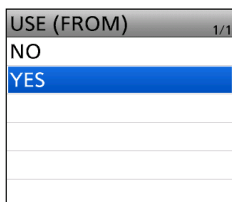

##### Step 9. Entering the access repeater frequency

1. Select "FREQUENCY."
2. Rotate [DIAL] to enter the repeater frequency.

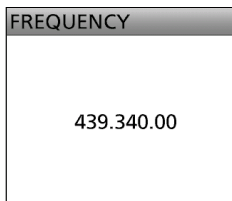

- ① Push D-pad(↔) to move the cursor.
3. After entering, push [ENT].

##### Step 10. Selecting the Duplex direction

① When **Step 2. Selecting the communication type** is set to "DV Simplex" or "FM Simplex," this item is not displayed.

① "DUP-" is automatically set when the access repeater frequency is entered in **Step 9. Entering the access repeater frequency**. If necessary, you can change the Duplex direction.

1. Select "DUP."
2. Select a Duplex direction.

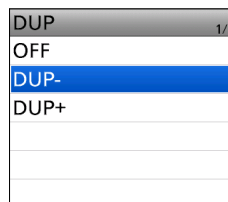

- **OFF:** Turn the duplex function OFF.
- **DUP-:** The transmit frequency shifts down from the receive frequency by the offset amount.
- **DUP+:** The transmit frequency shifts up from the receive frequency by the offset amount.

##### Step 11. Entering the frequency offset

① When **Step 2. Selecting the communication type** is set to "DV Simplex" or "FM Simplex," this item is not displayed.

① The offset value\* is automatically set when the access repeater frequency is entered in **Step 9. Entering the access repeater frequency**. If necessary, you can change the frequency offset.

\* The default value differs, depending on the transceiver version.

1. Select "OFFSET FREQ."
2. Rotate [DIAL] to enter the frequency offset (0.000.00 ~ 59.995.00 MHz).



- ① Push D-pad(↔) to move the cursor.
3. After entering, push [ENT].

## 5 D-STAR OPERATION (ADVANCED)

### Entering new information into the repeater list

#### ◇ Entering new information into the repeater list

##### Step 12. Setting the FM mode

① When **Step 2. Selecting the communication type** is set to “DV Repeater” or “DV Simplex,” this item is not displayed.

1. Select “MODE.”
2. Select “FM” or “FM-N.”



##### Step 13. Setting the tone

① When **Step 2. Selecting the communication type** is set to “DV Repeater” or “DV Simplex,” this item is not displayed.

1. Select “TONE.”
2. Select an option.

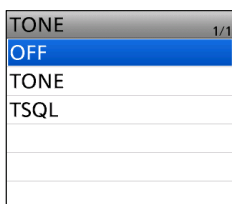

- **OFF:** Turn OFF the Tone function.
- **TONE:** Select when the repeater requires an access tone.
- **TSQL:** Select when you want to use the tone squelch in simplex operation.

##### Step 14. Selecting the repeater tone frequency

① When **Step 2. Selecting the communication type** is set to “DV Repeater” or “DV Simplex,” this item is not displayed.

① This setting is required when **Step 13. Setting the tone** is set to “TONE” or “TSQL.”

1. Select “REPEATER TONE.”
2. Rotate [DIAL] to select the repeater tone frequency, and then push [ENT].

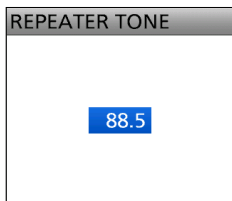

##### Step 15. Selecting the position data accuracy level

① When the Near Repeater Search function is not used, or the distance between your location and a repeater is not needed, select “OFF,” and go to **Step 18. Setting the UTC offset.**

1. Select “POSITION.”
2. Select the position data accuracy level.

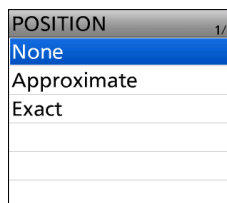

- **None:** Select when the repeater has no position data.
- **Approximate:** Select when the entered position data is approximate.
- **Exact:** Select when the entered position data is exactly correct.

##### Step 16. Entering the latitude

① This item is displayed only when **Step 15. Selecting the position data accuracy level** is set to “Approximate” or “Exact.”

1. Select “LATITUDE.”
2. Rotate [DIAL] to enter the latitude.



① Push D-pad(↔) to move the cursor.

① To enter a north latitude, select “N,” and to enter a south latitude, select “S.”

3. After entering, push [ENT].

## 5 D-STAR OPERATION (ADVANCED)

### Entering new information into the repeater list

#### ◇ Entering new information into the repeater list

##### Step 17. Entering the longitude

① This item is displayed only when **Step 15.**  
**Selecting the position data accuracy level** is set to "Approximate" or "Exact."

1. Select "LONGITUDE."
2. Rotate [DIAL] to enter the longitude.

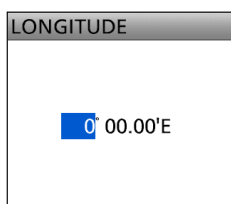

- ① Push D-pad(↔) to move the cursor.
  - ① To enter an east longitude, select "E," and to enter a west longitude, select "W."
3. After entering, push [ENT].

##### Step 18. Setting the UTC offset

① Universal Time Coordinated (UTC) offset is the time difference between UTC and repeater local time. This is a useful function to know the repeater's local time before you make a call. (p. 5-13)

1. Select "UTC OFFSET."
2. Rotate [DIAL] to set the time difference between UTC and the local time, then push [ENT].

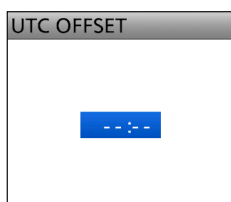

##### Step 19. Saving the repeater list

1. Select "<<Add Write>>."
  - The confirmation dialog is displayed.
2. Select "YES."



- The entered contents are saved to the repeater list, and the display returns to the selected repeater group screen.

##### TIP: To cancel the entered data

1. Push [CLR] to display the "Cancel edit?" window.
2. Select "YES."

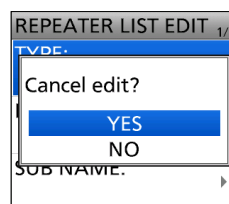

- Cancels the entry and returns to the selected repeater group screen.

## Repeater list operation

### ◇ Editing repeater data

You can edit repeater data. This is useful when already-entered data is incorrect, has changed, or some data needs to be added to the list.

[MENU] > MEMORY > Repeater List

1. Push [MENU].
2. Select “MEMORY” on the second page of the MENU screen.
3. Select “Repeater List.”



4. Select a repeater group where the repeater you want to edit is listed.



5. Select a repeater you want to edit, and then push [QUICK].
6. Select “Edit.”

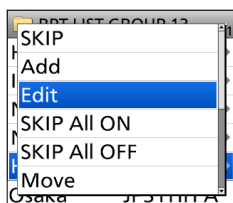

7. Select an item, and then edit it.  
① See pages 5-32 ~ 5-35 for details.
8. After editing, select “<<Overwrite>>.”

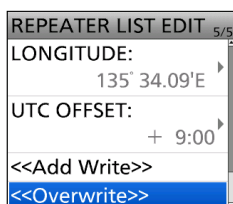

- The confirmation dialog is displayed.

9. Select “YES.”

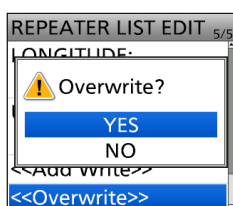

- The edited contents are saved to the repeater list and return to the selected repeater group screen.

- ① To exit the MENU screen, push [MENU].

### ◇ Deleting repeater data

[MENU] > MEMORY > Repeater List

1. Push [MENU].
2. Select “MEMORY” on the second page of the MENU screen.
3. Select “Repeater List.”

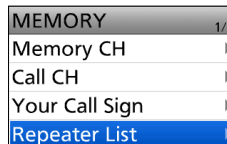

4. Select a repeater group where the repeater you want to delete is listed.



5. Select the repeater to be deleted, and then push [QUICK].
6. Select “Delete.”

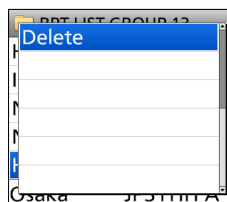

- The confirmation dialog is displayed.

7. Select “YES.”

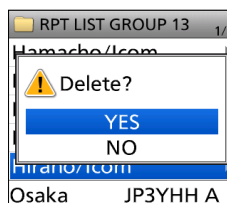

- The selected repeater contents are deleted from the repeater list and return to the selected repeater group screen.

- ① To exit the MENU screen, push [MENU].

**NOTE:** The currently selected repeater on the DR screen cannot be edited or deleted. To edit or delete the repeater, select another repeater on the DR screen.

# 5 D-STAR OPERATION (ADVANCED)

## Repeater list operation

### ◇ Rearranging the display order of the repeaters

You can move the entered repeaters to rearrange their display order in the selected repeater group.

[MENU] > MEMORY > Repeater List

1. Push [MENU].
2. Select "MEMORY" on the second page of the MENU screen.
3. Select "Repeater List."

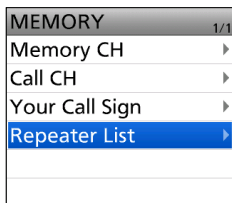

4. Select a repeater group where the repeater you want to move is listed.



5. Select the repeater to be moved.



① **DO NOT** push [ENT].

6. Push [QUICK].
7. Select "Move."

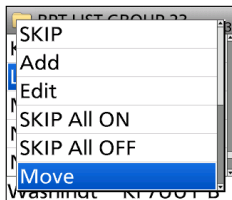

8. Select the position to insert the repeater you want to move the repeater above.

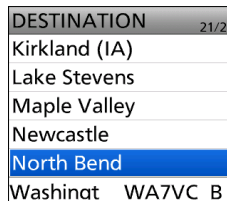

① While moving, "DESTINATION" blinks at the top left of the screen.

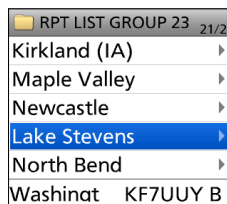

- The selected repeater is inserted above the destination repeater name.
- ① If "<<Move End>>" is selected, the repeater is moved to the bottom of the group.
  - ① To exit the MENU screen, push [MENU].

# 5 D-STAR OPERATION (ADVANCED)

## Repeater list operation

### ◇ Adding new repeater information from RX History

1. Hold down [CD] for 1 second.
  - The RX HISTORY screen is displayed.
2. Push D-pad(↑) to display the repeater you want to add to the repeater list, then push [ENT].

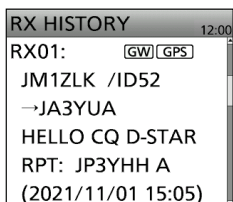

- Displays the RX history detail screen.
3. Push D-pad(↑) to display “RXRPT1” and “RXRPT2.”

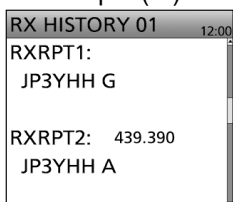

4. Push [QUICK].
5. Select “Add To RPT List.”

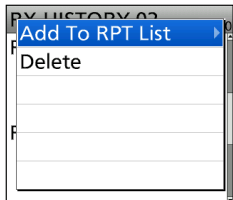

6. Select the repeater call sign that you want to add to the repeater list.

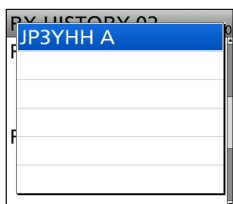

- Displays the REPEATER LIST EDIT screen. The selected repeater call sign is automatically entered.
  - ① If the selected repeater is already in the repeater list, “Duplicate Call Sign” is displayed.
  - ① See pages 5-32 ~ 5-35 to edit the contents.
7. Select “<<Add Write>>.”

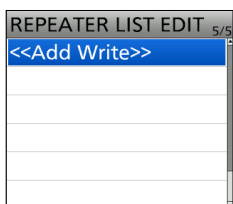

- The confirmation dialog is displayed.

8. Select “YES.”

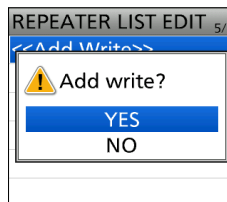

- The repeater contents are added to the repeater list, and the display returns to the RX HISTORY screen.
- ① To exit the RX HISTORY screen, push [MENU].

# 5 D-STAR OPERATION (ADVANCED)

## Repeater list operation

### ◇ Skip setting for the DR scan

You can set repeaters as scan skip repeaters. The selected repeaters are skipped for faster scanning. You can set the skip setting to all repeaters in the selected repeater group or individual repeaters.

① When a repeater is set as a skip repeater, its “USE (FROM)” setting is automatically set to “NO.” In that case, the repeater cannot be selected in “FROM” (access repeater) on the DR screen.

#### <Individual skip setting>

[MENU] > MEMORY > Repeater List

1. Push [MENU].
2. Select “MEMORY” on the second page of the MENU screen.
3. Select “Repeater List.”

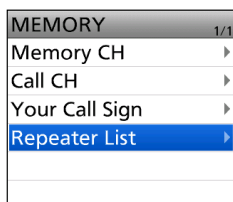

4. Select a repeater group where the repeater you set the skip setting is listed.



5. Select the repeater to be skipped, and then push [QUICK].
6. Select “SKIP.”

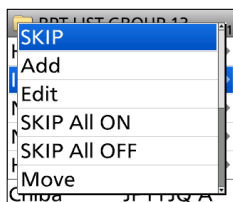

① Displays “SKIP” by the selected repeater.

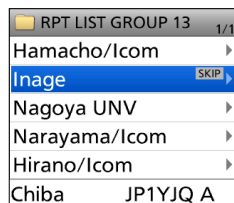

- ① Select “SKIP” again to cancel the skip setting.
- ① Select “SKIP All ON” to set the skip setting to all repeaters in the group.

#### <Group skip setting>

1. On the REPEATER GROUP screen, select a repeater group, as described to the left.
2. Push [QUICK], then select “SKIP All ON” to skip the group’s repeaters during the DR scan.
  - ① To cancel the skip settings in the group, select “SKIP All OFF.”

#### TIP:

- When you select “Repeater List” on the FROM SELECT screen, you can set the skip setting as described to the left.
- When “FROM” is selected on the DR screen, push [QUICK] to set the skip setting, as shown below.

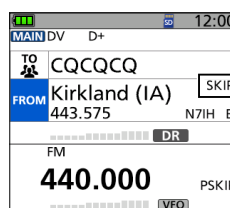
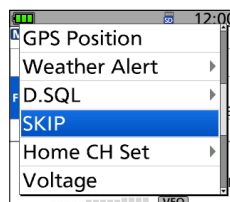

① Displays “SKIP” in the “FROM” field.

# 5 D-STAR OPERATION (ADVANCED)

## Repeater list operation

### ◇ Entering or editing a repeater group name

[MENU] > MEMORY > Repeater List

1. Push [MENU].
2. Select "MEMORY" on the second page of the MENU screen.
3. Select "Repeater List."

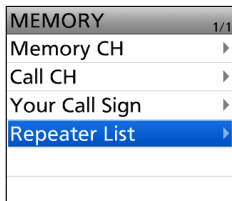

4. Select a Repeater group that you edit the name.

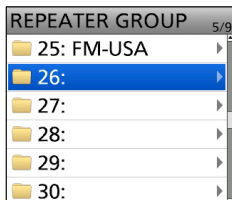

ⓘ **DO NOT** push [ENT].

ⓘ If you select an already named group, the name is overwritten.

5. Push [QUICK].
6. Select "Edit Name."

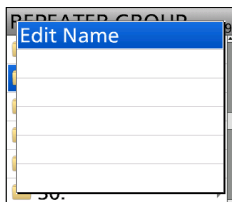

7. Enter a group name of up to 16 characters.

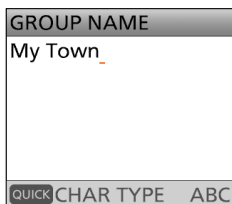

#### Selectable characters and symbols

A to Z, a to z, 0 to 9, ! " # \$ % & ' ( ) \* + , - . / : ; < = > ?  
 @ [ \ ] ^ \_ ` { | } ~ (space)

ⓘ See page iii on how to enter characters.

8. After entering [ENT].



• Sets the entered name.

ⓘ To exit the MENU screen, push [MENU].

## Your Call Sign

### ◇ Entering Your Call Sign

You can manually enter a Your (destination) Call Sign. When a Your Call Sign is entered into “TO,” you can make a call to the station, even if you do not know where the station is currently located. Up to 300 “Your Call Signs” can be entered.

[MENU] > MEMORY > **Your Call Sign**

**Example:** Entering “Rick/JM1ZLK” to the Your Call Sign memory.

1. Push [MENU].
2. Select “MEMORY” on the second page of the MENU screen.
3. Select “Your Call Sign.”

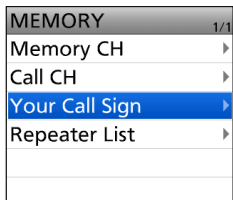

4. Push [QUICK] on the YOUR CALL SIGN screen.
5. Select “Add.”

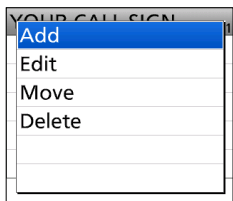

6. Select “NAME.”

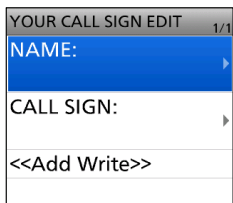

7. Enter a station name of up to 16 characters.

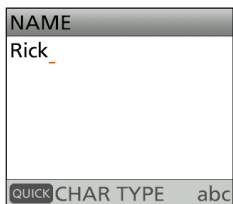

① See page iii on how to enter characters.

8. After entering, push [ENT].

9. Select “CALL SIGN.”

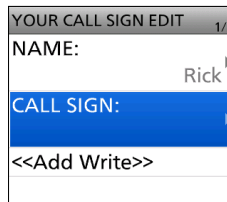

10. Enter a call sign of up to 8 characters, including spaces.

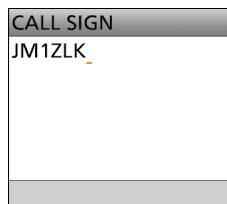

11. After entering, push [ENT].
12. Select “<<Add Write>>.”

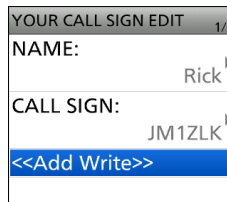

• The confirmation dialog is displayed.

13. Select “YES.”

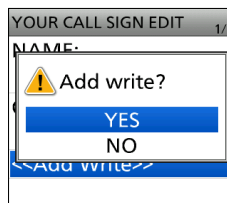

• “Rick JM1ZLK” is entered into the Your Call Sign memory.

- ① To exit the MENU screen, push [MENU].

## Your Call Sign

### ◇ Entering Your Call Sign

**TIP:**

**To cancel the entered call sign**

1. Push [CLR] to display the “Cancel edit?” window.
2. Select “YES” to cancel the entry and return to the YOUR CALL SIGN screen.

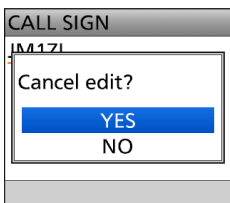

**To edit the entered call sign**

To edit the entered call sign, select “Edit” in step 5. This is useful when already-entered data is incorrect, has changed, or some data needs to be added to the list.

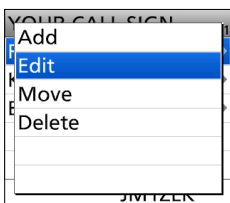

### ◇ Deleting Your Call Sign

[MENU] > MEMORY > Your Call Sign

1. Push [MENU].
2. Select “MEMORY” on the second page of the MENU screen.
3. Select “Your Call Sign.”

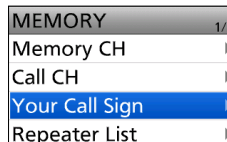

4. Select a call sign you want to delete.



ⓐ **DO NOT** push [ENT].

5. Push [QUICK].
6. Select “Delete.”

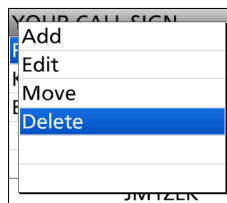

- A confirmation dialog is displayed.

7. Select “YES.”

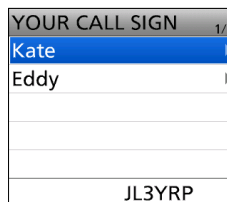
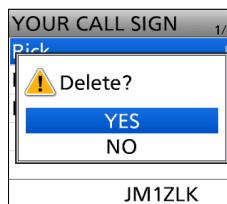

- The selected call sign is deleted from the Your Call Sign list and the returns to the YOUR CALL SIGN screen.

ⓐ To exit the MENU screen, push [MENU].

**NOTE:** The currently selected Your Call Sign on the DR screen cannot be edited or deleted. To edit or delete the Your Call Sign, select another Your Call Sign on the DR screen

# 5 D-STAR OPERATION (ADVANCED)

## Your Call Sign

### ◇ Rearranging the display order of Your Call Signs

You can move Your Call Signs to rearrange their display order.

If the stations you often communicate with are moved to the top of the list, it is easy to find them.

[MENU] > MEMORY > **Your Call Sign**

**Example:** Moving “Rick” above “Eddy.”

1. Push [MENU].
2. Select “MEMORY” on the second page of the MENU screen.
3. Select “Your Call Sign.”

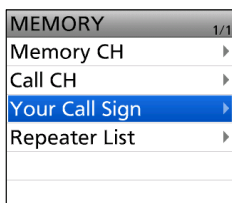

4. Select a Your Call Sign to be moved.

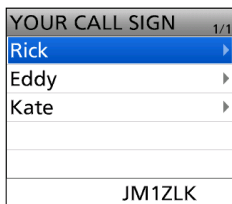

① **DO NOT** push [ENT].

5. Push [QUICK].
6. Select “Move.”

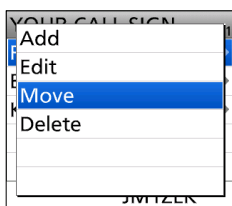

7. Select the position to insert the Your Call Sign you want to move the call sign above.



① While moving, “DESTINATION” blinks at the top left of the screen.

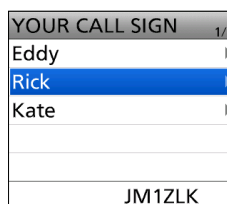

- The selected call sign is inserted above the destination call sign.

- ① If “<<Move End>>” is selected, the Your Call Sign is moved to the bottom of the group.
- ① To exit the MENU screen, push [MENU].

## Are your settings correct?

If you make a Local Area call with a gateway repeater still selected in “TO,” the destination repeater will be busy while you transmit. The stations that want to use the repeater as their access repeater cannot access it, as shown below.

**BE SURE** to set CQCQCQ in “TO” on the DR screen when you intend to make a Local Area call or finish a Gateway call.

**Example:** JA3YUA wants to make a Local Area call.

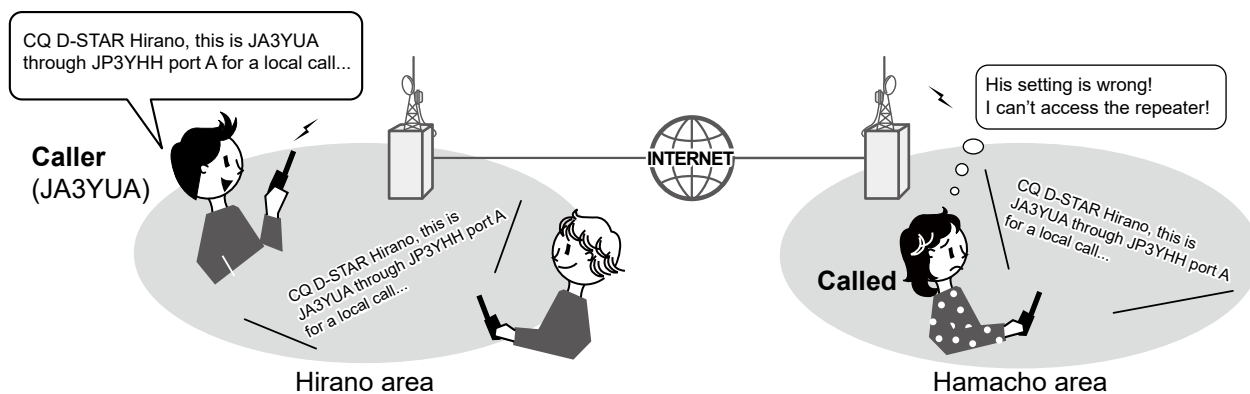

### JA3YUA's setting

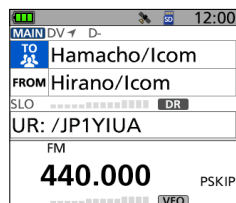

The destination (“TO”) setting is incorrect.

### Correct setting

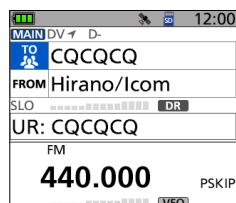

To make a Local Area call, set the destination (“TO”) to “CQCQCQ.” See page 5-9 for details.

**NOTE:** With this setting, you can make a Local Area call, but the destination Repeater, selected in “TO,” is also busy while you transmit. The stations that want to use the repeater as their Access Repeater cannot access it.

|  |      |
|--|------|
| GPS operation features .....   | 6-2  |
| Before starting GPS operation.....                                       | 6-3  |
| ◇ Confirming the GPS signal receiving.....                               | 6-3  |
| GPS TX mode and TX format types .....                                    | 6-4  |
| Difference between older models .....                                    | 6-4  |
| When a received signal contains position data .....                      | 6-5  |
| Checking your location .....   | 6-5  |
| ◇ Displaying Position Data .....   | 6-5  |
| ◇ GPS POSITION screens and their meanings .....                          | 6-6  |
| ◇ About the RX screen .....  | 6-7  |
| ◇ Setting the display type (MAIN/SUB) .....                              | 6-8  |
| ◇ About the Course .....   | 6-8  |
| ◇ About the Grid Locator .....   | 6-9  |
| ◇ Changing the GPS Memory or Alarm .....                                 | 6-9  |
| ◇ Changing the Compass Direction.....                                    | 6-10 |
| ◇ Saving your own or a received station's position.....                  | 6-10 |
| Checking GPS information (Sky view screen).....                          | 6-11 |
| Transmitting D-PRS data.....   | 6-12 |
| ◇ D-PRS .....  | 6-12 |
| ◇ Operating in the D-PRS mode.....                                       | 6-12 |
| ◇ Displayed items .....  | 6-13 |
| ◇ Setting D-PRS Position (Mobile/Base).....                              | 6-14 |
| ◇ Setting D-PRS Object/Item.....   | 6-15 |
| ◇ Setting D-PRS Weather.....   | 6-16 |
| ◇ Weather station transmission .....                                     | 6-17 |
| ◇ Application setting .....  | 6-17 |
| ◇ Confirming the weather data input .....                                | 6-17 |
| ◇ About the weather data content .....                                   | 6-17 |
| ◇ Displaying your location using mapping software .....                  | 6-18 |
| Transmitting NMEA data.....  | 6-20 |
| ◇ Setting the GPS data sentence .....                                    | 6-20 |
| ◇ Setting a GPS message .....  | 6-21 |
| GPS Automatic Transmission .....   | 6-21 |
| GPS Memory .....   | 6-22 |
| ◇ Adding a GPS Memory.....   | 6-22 |
| ◇ Entering the GPS Memory group name .....                               | 6-25 |
| ◇ Deleting the GPS Memory.....   | 6-25 |
| ◇ Rearranging the display order of the GPS data .....                    | 6-26 |
| GPS Alarm.....   | 6-27 |
| ◇ Setting the GPS Alarm function to All Memories (all GPS Memories)..... | 6-28 |
| ◇ Setting the GPS Alarm function to RX (a caller station) .....          | 6-29 |
| GPS items .....  | 6-30 |

## GPS operation features

### D-PRS Extension function (p. 6-4)

The D-PRS Extension function enables you to transmit or receive Object, Item, and Weather information in addition to Position data. With this extension, you can simultaneously transmit or receive earthquake information, traffic accident information, emergency information, or weather information, and so on, along with voice audio in the DV mode.

### GPS Memory (p. 6-22)

You can enter up to 300 GPS Memories in the transceiver. By adding destination position information in a GPS Memory, you can effectively use the GPS Alarm function. The position information that you acquired can also be entered in a GPS Memory.

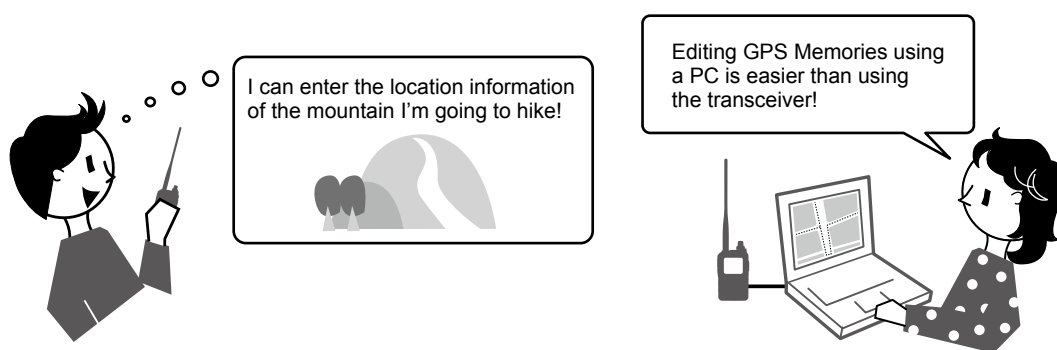

### GPS Alarm function (p. 6-27)

When a target station comes into the set alarm area, or when you approach an entered GPS Memory position, the function can sound an alarm. With this function, you can know that you are approaching the destination.



### GPS Logger function

The GPS Logger function enables you to save the position data from a GPS receiver into a microSD card as a log. If you use this GPS Logger while driving, you can check your driving history on a mapping software program.

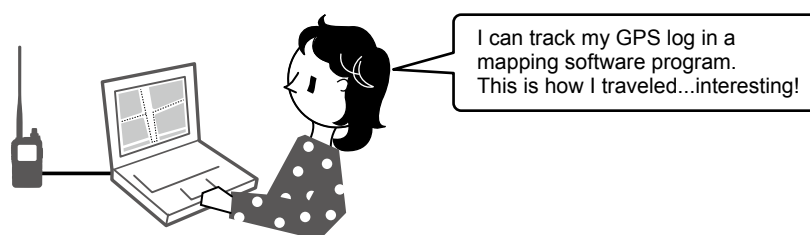

See "Using the GPS Logger function" that can be downloaded from the Icom website about using the function.  
<https://www.icomjapan.com/support/>

## Before starting GPS operation

**NOTE:** Before using the GPS function, read “IMPORTANT NOTES” about the GPS receiver in the Basic manual.

The transceiver has a built-in internal GPS receiver. The GPS receiver’s position data can be received in any mode.

**NOTE:** Transmit or receive position data that can be transmitted in only the DV mode.

### ◇ Confirming the GPS signal receiving

Confirm the GPS receiver is receiving satellite signals. The GPS icon blinks when searching for satellites.

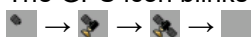

The GPS icon stops blinking when the minimum number of satellites needed is found.



#### ① Information

- It may take only a few seconds to receive, or it may take a few minutes, depending on your operating environment. If you have difficulties receiving, we recommend that you try a different position.
- When “GPS Select” is set to “Manual,” the icon is not displayed.  
([MENU] > GPS > GPS Set > **GPS Select**)

**NOTE:** Continuously using the Internal GPS mode causes the transceiver’s battery to be exhausted quickly. Turn ON the Power Save mode if needed. See page 6-30 for details.  
([MENU] > GPS > GPS Set > GPS Option > **Power Save**)

**TIP: To prolong the battery life in the GPS mode**  
Manually update your location with the received GPS data.

1. Set “GPS Select” to “ON,” and receive your position from the internal GPS receiver.  
([MENU] > GPS > GPS Set > **GPS Select**)
2. Open the MANUAL POSITION screen, and then push [QUICK].  
([MENU] > GPS > GPS Set > **Manual Position**)
3. Select “Capture From GPS.”

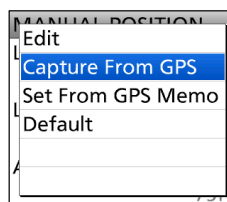

- Your current position is now memorized and displayed on the MANUAL POSITION screen.
4. Set “GPS Select” to “Manual.”  
([MENU] > GPS > GPS Set > **GPS Select**)

## GPS TX mode and TX format types

GPS position data has 2 TX modes, D-PRS, and NMEA. Moreover, with the D-PRS mode data, 5 position formats, Position (Mobile station/Base station), Object, Item, and Weather, are selectable.

**Example:** When the caller's TX format is D-PRS Position (Mobile)  
 ([MENU] > GPS > **GPS Position**)

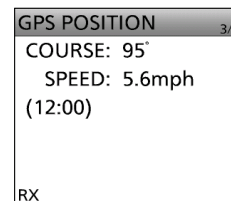

|                   |  |
|-------------------|--|
| D-PRS             | D-PRS is a function that simultaneously sends position data received from the internal GPS receiver, using the slow speed data packet space, along with voice. |
| Position (Mobile) | A station operating from a vehicle, or other position, away from its normal base position.   |
| Position (Base)   | A station operating at home or in a building.  |
| Object            | Transmitting Object data such as earthquake information, satellite tracking information, and so on.<br>An Object contains a time stamp.                        |
| Item              | Transmitting Item data such as a traffic accident, lighthouse, antenna, or DV access point position, and so on.<br>An Item does not contain a time stamp.      |
| Weather           | A station transmitting weather information received from a weather device.   |
| NMEA              | A station transmitting position data (NMEA0183) received from the internal GPS receiver.   |

## Difference between older models

(As of November 2021)

- The GPS TX mode, “GPS (DV-G)” and “GPS-A (DV-A),” are now called as “NMEA (DV-G)” and “D-PRS (DVA).”  
 GPS (DV-G) → NMEA (DV-G)  
 GPS-A (DV-A) → D-PRS (DV-A)
- For users who have one of the following models:  
 ID-800H, IC-91AD/E91, IC-U82, IC-V82, IC-7100, ID-51A/E, ID-31A/E, IC-9100, IC-80AD/E80D, ID-880H/E880, IC-92AD/E92D, IC-2820H/E2820  
 When you receive a D-PRS position (Base), Object, Item, or Weather information, their data is not displayed.
- Only the ID-51A/E PLUS, ID-51A/E PLUS2, ID-31A/E PLUS, ID-5100A/E, ID-4100A/E, IC-R30, IC-9700, IC-705, and ID-52A/E can receive Power, Height, Gain, and Directivity data.
- For users who have one of the following models:  
 IC-9100, IC-80AD/E80D, ID-880H/E880, IC-92AD/E92D, IC-U82, IC-V82  
 If you transmit with the Altitude setting ON, the character string is included in a comment on the products that cannot display the altitude.
- Set the GSV sentence to OFF when sending the GPS message to conventional digital transceivers (IC-2820H/E2820, ID-800H, IC-91AD/E91, IC-V82, IC-U82, IC-2200H). The GSV sentence is incompatible with them. They will not display GPS messages properly if sent as a GSV sentence from the ID-52A/E.

## When a received signal contains position data

When a received signal contains position data, the caller's position data is displayed on the RX position screen.

See to the right for details.

**Example:** When the signal from JM1ZLK contains position data.

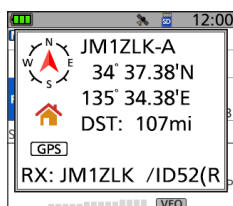

When you receive the signal, the RX position data is displayed in the RX position window.



After a few seconds, the window disappears.



←RX position icon

When the received signal contains position data, the RX position icon is displayed, as shown above.

- ① You can turn OFF the caller's position data display.  
([MENU] > SET > Display > **RX Position Display**)
- ① You can turn OFF the RX position icon indication.  
([MENU] > SET > Display > **RX Position Indicator**)

## Checking your location

You can check your current location. This section is described using received position data.

① The screens are just examples.

### ◇ Displaying Position Data

1. Push [QUICK].
2. Select "GPS Position."  
• Opens the GPS POSITION screen.
3. Rotate [DIAL].  
• Changes between the MY (My position), RX (Received position), MEM (GPS Memory position), or ALM (GPS Alarm position) screen.

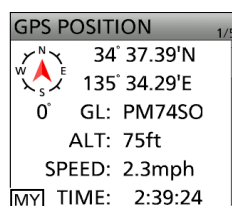

The displayed icon depends on the type of screen (MY, RX, MEM, or ALM).

4. To close the GPS POSITION screen, push [MENU].

**NOTE:** Latitude, longitude, and altitude data may differ, depending on your received GPS signal.

**TIP:**

- If you transmit with the GPS POSITION screen open, the screen closes. To check the location, push [QUICK], and then select "GPS Position" while transmitting.
- On the MY screen or RX screen, you can enter the displayed position information in a GPS Memory by pushing [QUICK] and select "GPS Memory."
- See page 6-22 about the GPS Memory function and see page 6-27 about the GPS Alarm function.

## Checking your location

### ◇ GPS POSITION screens and their meanings

#### ① Information

- Pushing to [QUICK], change the compass direction. (p. 6-10)
- About the Course (p. 6-8)
- About the Grid Locator (p. 6-9)

#### MY screen (Your position information)

When "GPS Select" is set to "Manual," the compass heading and course direction are not displayed. (p. 6-30) ([MENU] > GPS > GPS Set > **GPS Select**)

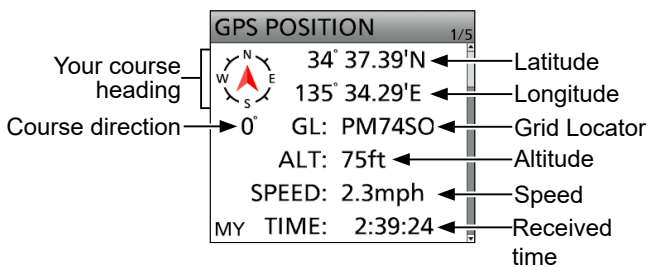

#### RX screen (Caller's position information)

Depending on the caller's GPS TX Mode and TX format, the displayed item's meanings may differ, and some data may not be displayed. (p. 6-7)

**Example:** The caller station's GPS TX Mode is "D-PRS," and its TX format is "Position (Mobile)."

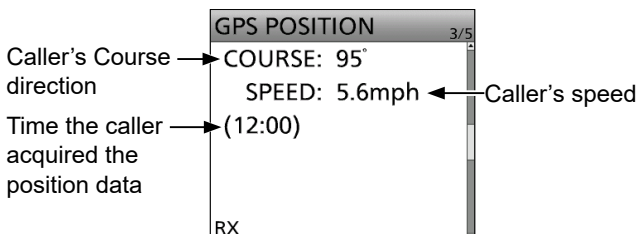
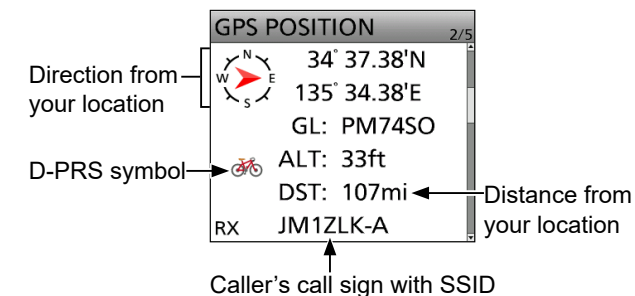

#### Example for the GPS POSITION screens:

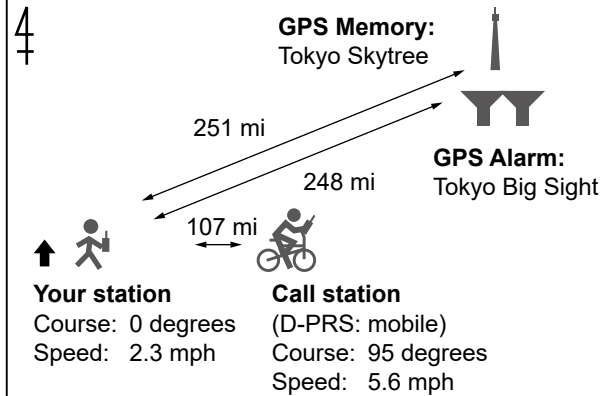

#### MEM screen (GPS Memory's information)

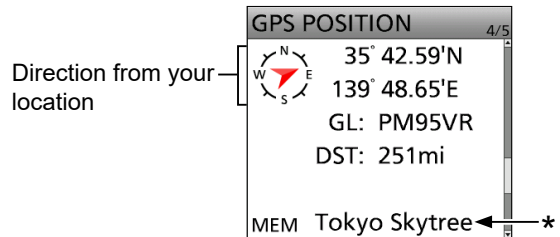

#### ALM screen (GPS Alarm's information)

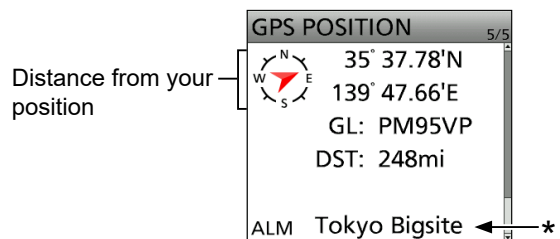

\* When a name is not entered in the GPS Memory channel, date and time are displayed instead of the name. You can change the GPS Memory or GPS Alarm in the GPS POSITION screen in the Quick Menu window. (p. 6-9)

# 6 GPS OPERATION (ADVANCED)

## Checking your location

### ◇ About the RX screen

**TX format:**

**D-PRS**

#### Position (Mobile)

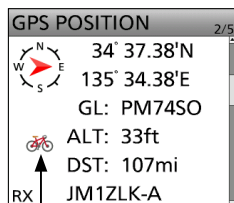

Moving symbol

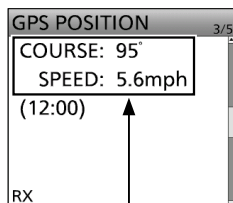

For a mobile station, Course and Speed are displayed.

#### Position (Base)

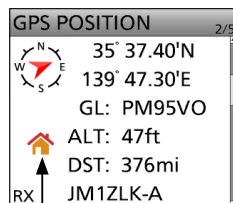

Base station symbol

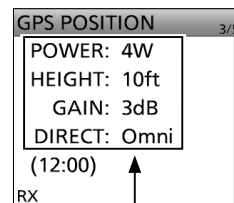

For a base station, Output power, Antenna height, Antenna gain, and Antenna direction are displayed.

#### Object

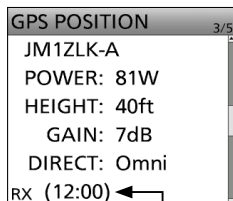
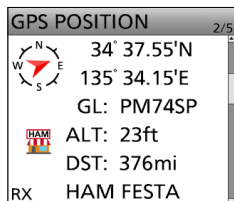

Time that the caller sent the Object's data.

#### Item

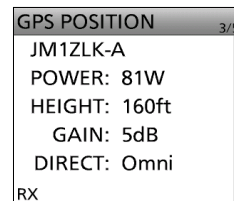

① For an Item station, Time is not displayed.

#### Weather

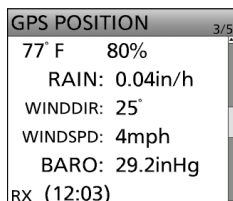
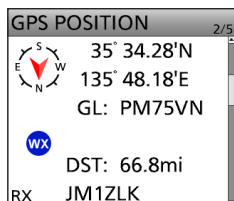

Time that the caller acquired the weather data.

① Call sign is displayed with an SSID.

① When the Object or Item is disabled, "KILLED" is displayed.

**TX format:**

**NMEA**

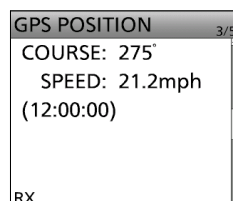

① A symbol or SSID is not displayed when the TX format is NMEA.

## Checking your location

### ◇ Setting the display type (MAIN/SUB)

You can select the display type of the RX screen.

1. Push [QUICK] when the RX screen is displayed.
2. Select "Display Select (MAIN/SUB)."

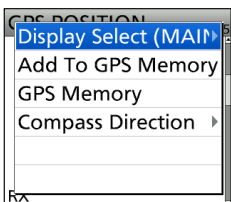

3. Select the item you want to switch.

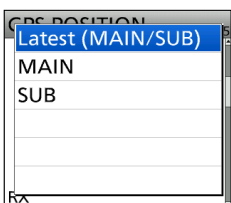

- Latest (MAIN/SUB): Displays the target station's latest location information regardless of the MAIN band or the SUB band.
- MAIN: Displays only the latest location information of the target station received in the MAIN band.
- SUB: Displays only the latest location information of the target station received in the SUB band.

### ◇ About the Course

The course displayed on the GPS POSITION screens is indicated in degrees.

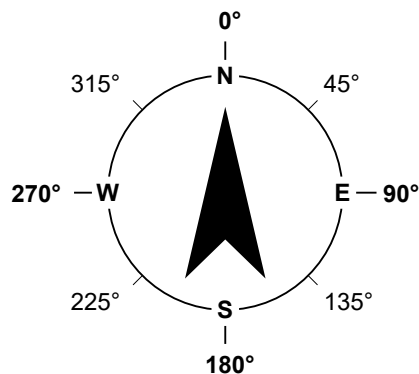

# 6 GPS OPERATION (ADVANCED)

## Checking your location

### ◇ About the Grid Locator

Grid Locator (GL) is a position compressed into a 6 character code, calculated by the longitude and the latitude.

The locator is simply calculated by dividing the earth's surface into squares.

It is used to find the location of a transceiver station.

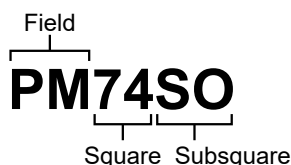
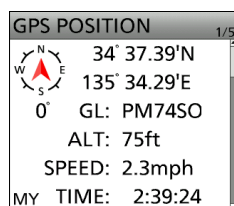

The grid locator map of Japan

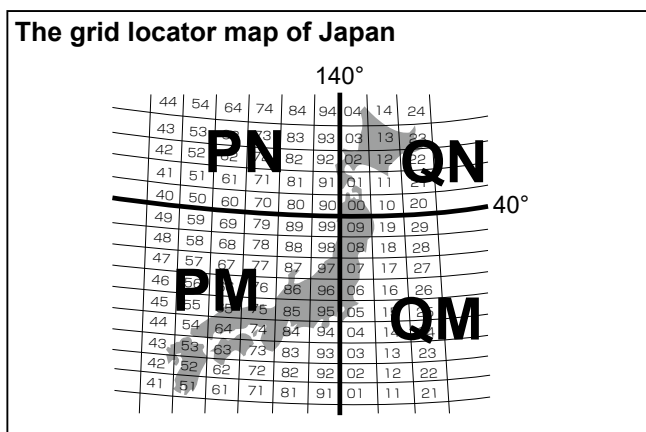

### ◇ Changing the GPS Memory or Alarm

You can change the GPS Memory or GPS Alarm in the GPS POSITION screen.

1. While selecting the MEM screen or ALM screen, push [QUICK].
2. Select "GPS Memory Select," or select "Alarm Select."

#### MEM screen

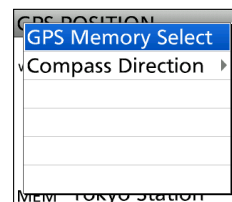
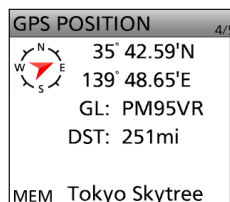

#### ALM screen

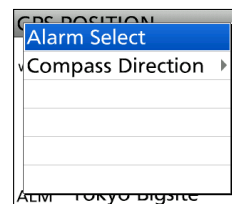
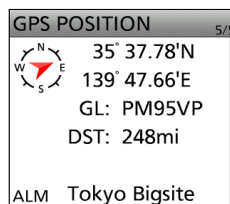

3. Select the GPS Memory or GPS Alarm to display on the GPS POSITION screen.
  - ① Adding or editing a GPS Memory: p. 6-22
  - ② Setting the GPS Alarm: p. 6-27

## Checking your location

### ◇ Changing the Compass Direction

You can set the compass direction to Heading Up, North Up, or South Up.

1. While displaying the GPS POSITION screen, push [QUICK].
2. Select "Compass Direction."

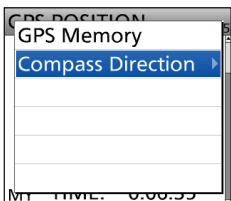

3. Select the compass direction.

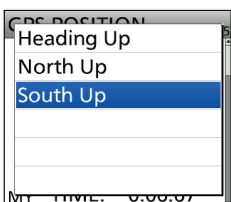

Heading Up

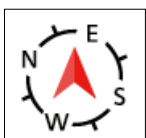

The top is always your course direction.

North Up

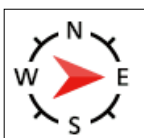

The top is always north.

South Up

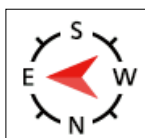

The top is always south.

### ◇ Saving your own or a received station's position

You can save the position of your station or the position of the caller station.

The transceiver has 300 GPS memories, and the memories can be assigned to one of 27 banks, A ~ Z, and (No Group).

1. Select the screen that you want to save.
  - ① To save your own position: MY screen
  - ① To save a received position: RX screen
2. Push [QUICK].
3. Select "Add To GPS Memory."

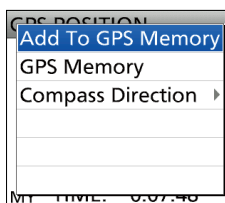

- ① See pages 6-22 ~ 6-24 for entering details.
4. Select "<<Add Write>>."

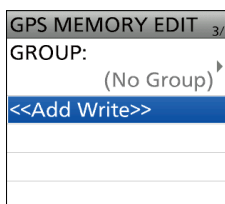

- ① To select the destination group to be saved, select "GROUP."
5. Select "YES."

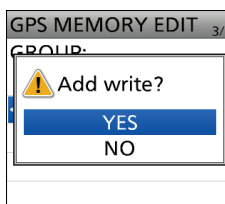

- Saves the data in the GPS Memory, then returns to the GPS POSITION screen.
6. To close the GPS POSITION screen, push [MENU].

**TIP:** The position is saved in the selected group in the GPS MEMORY EDIT screen. (Step 4)  
 ([MENU] > GPS > **GPS Memory**)

## Checking GPS information (Sky view screen)

This screen is used to view GPS satellite information when the GPS icon does not stop blinking for a long time.

The GPS Information displays the quantity, signal power, and position of the satellites.

The sky view screen displays the position of the satellites. The screen also displays each satellite's direction, elevation angle, satellite numbers, and their receiving signal strength status.

1. Push [QUICK].
2. Select "GPS Information."

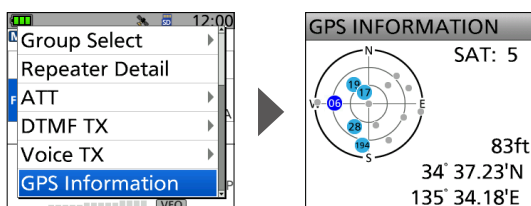

### About the display

- : Untracking satellite.
- : Tracking satellite with a weak signal, shown by the satellite number.
- : Tracking satellite with a strong signal, shown by the satellite number.
- SAT: The quantity of tracking satellites.
- Altitude: The altitude of your station. The altitude is only displayed when 4 or more satellites are tracked. When 3 or less satellites are tracked, "-----ft" is displayed.
- Longitude/Latitude: Longitude and Latitude of your station.

**TIP:** The following satellite number is assigned to the each satellite system.

- GPS: 01 ~ 32
- SBAS: 33 ~ 71
- GLONASS: 65 ~ 96
- QZSS: 193 ~ 202

3. To close the GPS INFORMATION screen, push [MENU].

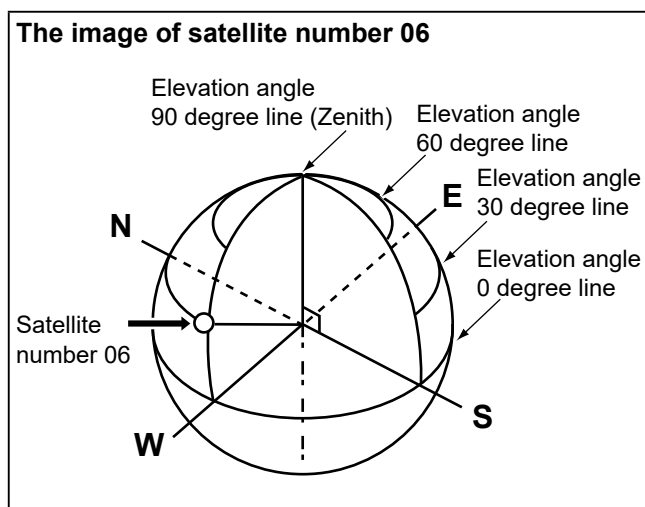
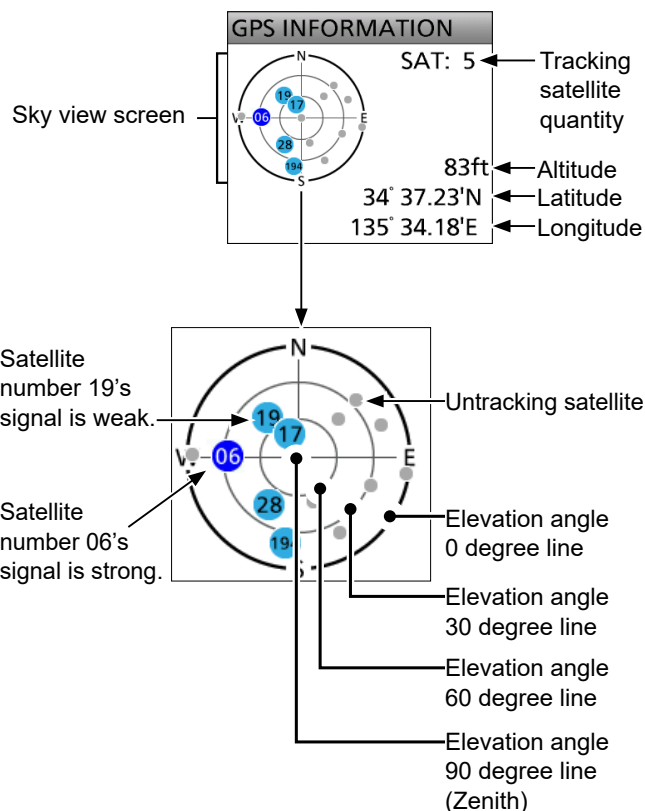

## Transmitting D-PRS data

When D-PRS is selected as the GPS TX mode, you can transmit D-PRS data.

When operating in the D-PRS mode, the following codes are transmitted to the PC.

D-PRS code is based on APRS® code.

(APRS®: Automatic Packet Reporting System)

### ◇ D-PRS

D-STAR Packet Reporting System (D-PRS) is a mode that simultaneously sends position data received from the internal GPS receiver, using the slow speed data packet space, along with voice audio in the DV mode. In the Analog mode, you can transmit or receive only voice audio or data at one time. However, a D-PRS capable radio can transmit or receive message data or GPS position data simultaneously when voice is being transmitted or received. An I-GATE is required to send position data to the APRS server.

#### NOTE:

- If "GPS select" is set to "Manual," the manually entered position data in "Manual Position" is changed to the D-PRS data format to transmit. ([MENU] > GPS > GPS Set > **GPS Select**)
- Note that if "GPS Auto TX" is set to any other setting than "OFF," it is transmitted according to the set time. ([MENU] > GPS > **GPS Auto TX**)

### The image of D-PRS

<Using a Repeater>

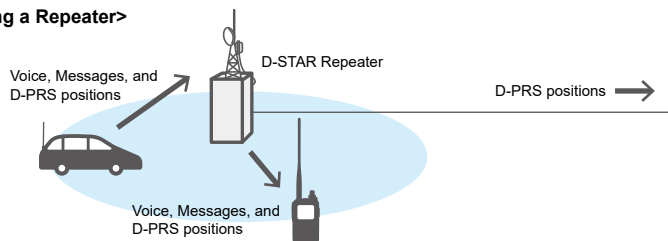

<Simplex>

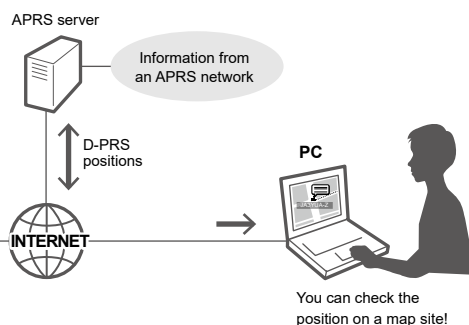
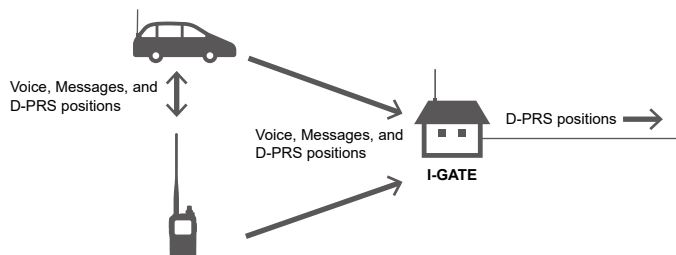

### ◇ Operating in the D-PRS mode

To transmit D-PRS data, follow the steps below. For more details, see the pages listed along with the steps.

1. Enter "MY" (Your own call sign).  
(Basic manual D-STAR GUIDE)
2. Confirm the GPS signal is receiving.
3. Set GPS TX mode to "D-PRS." (p. 6-14)
4. Set TX information.
  - ① You must set "SSID" and "Symbol."  
([MENU] > GPS > GPS TX Mode > **D-PRS**)

Complete! You can transmit in the D-PRS mode.

**TIP:** In the D-PRS mode, you can transmit earthquake or weather information, in addition to position data.

([MENU] > GPS > GPS TX Mode > D-PRS > **TX Format**)

#### TX format of D-PRS

- Position (Mobile/Base): Used to transmit position data.
- Object: Used to transmit specific position data. (Contains a time stamp.)
- Item: Used to transmit specific position data. (Does not contain a time stamp.)
- Weather: Used to transmit weather information.

## 6 GPS OPERATION (ADVANCED)

### Transmitting D-PRS data

#### ◇ Displayed items

Depending on the TX format, the setting items and displayed order of the items differ.

|   | D-PRS    |      |                     |                              |   |                     |                              |   |         |
|---|----------|------|---------------------|------------------------------|---|---------------------|------------------------------|---|---------|
|   | Position |      | Object              |                              |   | Item                |                              |   | Weather |
|   | Mobile   | Base | Data extension: OFF | Data extension: Course/Speed | Data extension: Power/Height/Gain/Directivity | Data extension: OFF | Data extension: Course/Speed | Data extension: Power/Height/Gain/Directivity |         |
| Unproto Address   | ✓        | ✓    | ✓                   | ✓                            | ✓   | ✓                   | ✓                            | ✓   |         |
| Comment   | ✓        | ✓    | ✓                   | ✓                            | ✓   | ✓                   | ✓                            | ✓   | ✓       |
| Altitude  | ✓        | ✓    |                     |                              |   |                     |                              |   |         |
| Object Name/<br>Item Name                                 |          |      | ✓                   | ✓                            | ✓   | ✓                   | ✓                            | ✓   |         |
| Data Type   |          |      | ✓                   | ✓                            | ✓   | ✓                   | ✓                            | ✓   |         |
| Position information<br>(Latitude/Longitude/<br>Altitude) |          |      | ✓                   | ✓                            | ✓   | ✓                   | ✓                            | ✓   |         |
| Data Extension  | ✓        | ✓    | ✓                   | ✓                            | ✓   | ✓                   | ✓                            | ✓   |         |
| Course  |          |      |                     | ✓                            |   |                     | ✓                            |   |         |
| Speed   |          |      |                     | ✓                            |   |                     | ✓                            |   |         |
| Power   |          | ✓    |                     |                              | ✓   |                     |                              | ✓   |         |
| Height  |          | ✓    |                     |                              | ✓   |                     |                              | ✓   |         |
| Gain  |          | ✓    |                     |                              | ✓   |                     |                              | ✓   |         |
| Directivity   |          | ✓    |                     |                              | ✓   |                     |                              | ✓   |         |
| Symbol  | ✓        | ✓    | ✓                   | ✓                            | ✓   | ✓                   | ✓                            | ✓   | ✓       |
| SSID  | ✓        | ✓    | ✓                   | ✓                            | ✓   | ✓                   | ✓                            | ✓   | ✓       |
| Time stamp  | ✓        | ✓    | ✓                   | ✓                            | ✓   |                     |                              |   | ✓       |

✓: Displayed

## Transmitting D-PRS data

### ◇ Setting D-PRS Position (Mobile/Base)

Set to transmit as a D-PRS Position (Mobile/Base).

① See page 6-31 for details.

#### 1. Setting the GPS TX Mode to D-PRS

[MENU] > GPS > GPS TX Mode > **D-PRS**

#### 2. Checking the Unproto Address

You should use the default address, and editing is not recommended.

#### 3. Setting the TX format to "Position"

Set "TX Format" to "Position."

#### 4. Selecting the Symbol

Select the Symbol that indicates your operating situation.

① See page 6-31 to directly enter the Symbol.

#### 5. Selecting the SSID

To help identify your station's type, select the APRS® (Automatic Packet Reporting System) based SSID after the D-PRS data call sign. (p. 6-32)

#### 6. Entering a comment

Enter a comment, and transmit it with the D-PRS position data.

① The number of characters you can enter differs, depending on the data extension and altitude settings. (p. 6-32)

1. Select "Comment."
2. Push [QUICK].
3. Select "Edit."
4. Enter a comment.
5. After entering, push [ENT].
6. Push [ENT] again.

#### 7. Setting the Time Stamp

Set the Time Stamp function to transmit the received time data in UTC (Universal Time Coordinated) time. (p. 6-32)

#### 8. Setting the Altitude

Set whether or not to transmit the altitude data acquired from the GPS receiver. (p. 6-33)

**NOTE:** If you transmit with the altitude setting ON, the character string is included in a comment on the products that cannot display the altitude. (p. 6-4)

#### 9. Setting the Data Extension

Set the data extension of your station's information.

① Set "Data Extension" to "Course/Speed" to transmit as a mobile station.

① Set "Data Extension" to "Power/Height/Gain/Directivity" to transmit as a base station.

#### When you set "Data Extension" to "Power/Height/Gain/Directivity":

##### 9-1. Setting the TX power

Select the TX power level of the base station to transmit along with the position data.

##### 9-2. Setting the antenna height

Select the height of the base station's antenna to transmit along with the position data.

##### 9-3. Setting the antenna gain

Select the gain of the base station's antenna to transmit along with the position data.

##### 9-4. Setting the antenna directivity

Select the direction the base station's antenna was pointing to transmit along with the position data.

#### 10. Exiting the POSITION screen

To close the POSITION screen, push [MENU].

- Returns to the standby screen, and then DV ↗ is displayed.

## Transmitting D-PRS data

### ◇ Setting D-PRS Object/Item

Set to transmit as a D-PRS Object or Item.

① See page 6-31 for details.

#### 1. Setting the GPS TX Mode to D-PRS

[MENU] > GPS > GPS TX Mode > **D-PRS**

#### 2. Checking the Unproto Address

You should use the default address, and editing is not recommended.

#### 3. Setting the TX format to “Object” or “Item”

Set “TX Format” to “Object” or “Item.”

#### 4. Entering Object name or Item name

Enter an Object or Item name, such as event information or location.

#### 5. Selecting Data type

Set the Object or Item’s status.

① For example, if you want to transmit finished event information as an Object, set the Date type to “Killed Object.”

#### 6. Setting the Symbol

Select the Symbol that indicates an Object or Item.

① See page 6-31 to directly enter the Symbol.

#### 7. Entering a comment

Enter a comment to transmit as an Object or Item.

① The number of characters you can enter differs, depending on the data extension and altitude settings. (pp. 6-34, 6-36)

1. Select “Comment.”
2. Push [QUICK].
3. Select “Edit.”
4. Enter a comment.
5. After entering, push [ENT].
6. Push [ENT] again.

#### 8. Entering the Position data

Enter the position data of an Object or Item.

① For example, if you want to transmit traffic accident information as an Item, enter the position data where the accident happened.

If the position data is in the GPS memory, you can easily set the position data from the memory.

#### 9. Setting the Data Extension

Set the data extension of an Object or Item’s information.

① Set “Data Extension” to “Course/Speed” to transmit as a mobile station.

② Set “Data Extension” to “Power/Height/Gain/Directivity” to transmit as a base station.

##### When you set “Data Extension” to “Course/Speed”:

##### 9-1. Entering the Course

Enter the Object or Item’s course when the station moves.

##### 9-2. Entering the Speed

Enter the Object or Item’s speed.

##### When you set “Data Extension” to “Power/Height/Gain/Directivity”:

##### 9-3. Setting the TX power

Select the Object or Item’s TX power level if the station is a repeater, node, access point, and so on, and an antenna is installed.

##### 9-4. Setting the antenna height

Select the height of the Object or Item’s antenna.

##### 9-5. Setting the antenna gain

Select the gain of the Object or Item antenna.

##### 9-6. Setting the antenna directivity

Select the direction the base Object or Item’s antenna is pointing.

#### 10. Selecting the SSID

To help identify your station’s type, select the APRS® (Automatic Packet Reporting System) based SSID after the D-PRS data call sign. (p. 6-32)

#### 11. Setting the Time Stamp

① This item is displayed when the TX format is “Object.”

Set the Time Stamp function to transmit the received time data in UTC (Universal Time Coordinated) time. (p. 6-35)

#### 12. Exiting the OBJECT or ITEM screen

To close the OBJECT or ITEM screen, push [MENU].

- Returns to the standby screen, and then DV ↗ is displayed.

### Transmitting D-PRS data

#### ◇ Setting D-PRS Weather

Set to transmit as a D-PRS Weather station.

① See page 6-31 for details.

##### 1. Setting the GPS TX Mode to D-PRS

[MENU] > GPS > GPS TX Mode > **D-PRS**

##### 2. Checking the Unproto Address

You should use the default address, and editing is not recommended.

##### 3. Setting the TX format to “Weather”

Set “TX Format” to “Weather.”

##### 4. Selecting the Symbol

Select the Symbol that indicates the weather station.

① See page 6-31 to directly enter the Symbol.

##### 5. Selecting the SSID

To help identify your station’s type, select the APRS® (Automatic Packet Reporting System) based SSID after the D-PRS data call sign. (p. 6-32)

##### 6. Entering a comment

Enter a comment to transmit as a D-PRS Weather station.

1. Select “Comment.”
2. Push [QUICK].
3. Select “Edit.”
4. Enter a comment.
5. After entering, push [ENT].
6. Push [ENT] again.

##### 7. Setting the Time Stamp

Set the Time Stamp function to transmit the received time data in UTC (Universal Time Coordinated) time. (p. 6-38)

##### 8. Exiting the WEATHER screen

To close the WEATHER screen, push [MENU].

- Returns to the standby screen, and then DV↵ is displayed.

## Transmitting D-PRS data

### ◇ Weather station transmission

When you transmit as a weather station, you should set the weather station's settings and input the weather data into the [USB] port. You can input the weather data from a third party's weather device by converting it to the APRS weather format in your PC or microcomputer.

After completing the weather station's settings and inputting the weather data, you can transmit as a weather station.

**NOTE:** To input the Weather data into the [USB] port, set "USB Connect" to "Serialport," and set "USB Serialport function" to "DV Data."  
 ([MENU] > SET > Function > **USB Connect**)  
 ([MENU] > SET > Function > **USB Serialport function**)  
 If the weather data is not input into the [USB] port, you cannot transmit as a weather station.

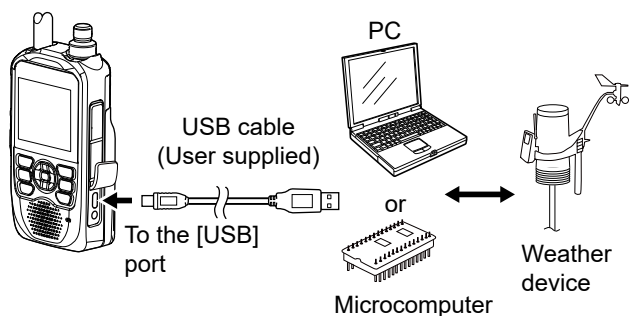

### ◇ Application setting

Configure the communication software as follows.

- Port: The COM port number that is used by the transceiver.\*
- Baud rate: Your desired speed
- Data: 8 bit
- Parity: none
- Start: 1 bit
- Stop: 1 bit
- Flow control: none

\* Depending on the PC environment, the COM port number used by the ID-52A/E may be higher than 5. In that case, use an application that can set it to higher than 5.

### ◇ Confirming the weather data input

You can confirm whether or not the weather data is input into the [USB] port.

1. Set "GPS TX Mode" to "D-PRS," and "TX format" to "Weather." (p. 6-16)
  2. On the Standby screen, push [QUICK].
  3. Select "Weather Information."
- ① Displays the WEATHER INFORMATION screen if the weather data is entered correctly.  
 ② When the weather information is displayed, you can transmit as a weather station. If "-" is displayed on the screen, the weather data is not entered. In that case, check the entered data settings.

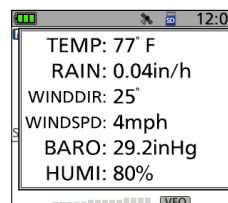

### ◇ About the weather data content

The weather data should be input according to the format (based on the APRS® Weather Data), shown below.

#### Example:

220/004 g005 t077 r000 p000 P000 h50 b09900 End code  
 1 2 3 4 5 6 7 8 9

| No. | Item                | Value                                    | Unit       |
|-----|---------------------|--|------------|
| 1   | Wind direction      | 000 to 360                               | °          |
| 2   | Wind speed          | 000 to 999                               | mph        |
| 3   | Gust speed          | g000 to g999                             | mph        |
| 4   | Temperature         | t-99 to t-01,<br>t000 to t999            | °F         |
| 5   | Rainfall            | r000 to r999* <sup>1</sup>               | inch       |
| 6   | Rainfall (24 Hours) | p000 to p999* <sup>1</sup>               | inch       |
| 7   | Rainfall (Midnight) | P000 to P999* <sup>1</sup>               | inch       |
| 8   | Humidity            | h00, h01 to h99<br>(h00 indicates 100%.) | %          |
| 9   | Barometric pressure | b00000 to b99999* <sup>2</sup>           | hPa,<br>mb |

\*<sup>1</sup> The last two digits indicate the one decimal place and the two decimal places.

\*<sup>2</sup> The last digit indicates the one decimal place.

① If you have no data, enter a space or "." (period) instead of a number.

(Example: ".../...g...t077r000p...P...h50b.....")

② Enter <CR>, <LF>, or <CR><LF> for an end code.

## 6 GPS OPERATION (ADVANCED)

### Transmitting D-PRS data

#### ◇ Displaying your location using mapping software

If you transmit to an I-GATE station, and then enter the call sign information on the Internet map website, the selected symbol is displayed.

**Example:** Check your location on the APRS.fi site.

1. Display a free APRS® related map site on the Internet. (Example: <http://aprs.fi/> )
2. Enter your call sign in the “Track callsign” field.
3. Click <Search>.
  - The icon (D-PRS symbol) is displayed on the map site.

You can check it on the Internet!



Enter your call sign,  
and then click <Search>.

Track callsign:

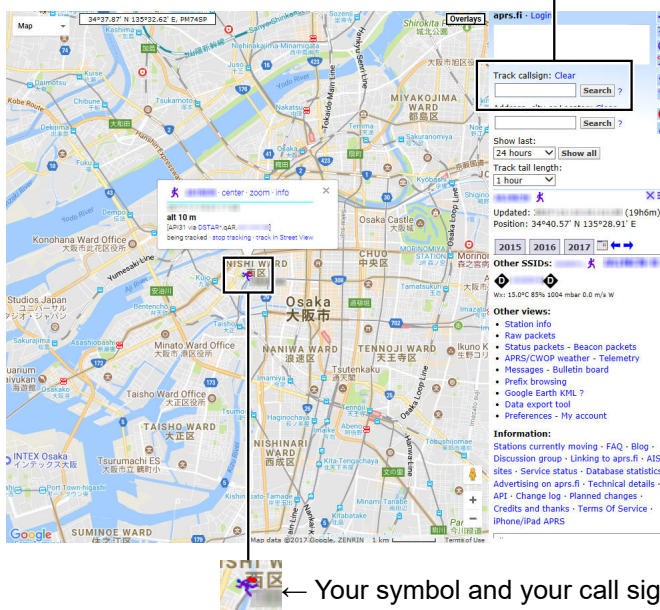

← Your symbol and your call sign

# 6 GPS OPERATION (ADVANCED)

## Transmitting D-PRS data

**TIP:**

**D-PRS data content**

D-PRS data content are shown below.

◇Position (Mobile)

(e.g.) JA3YUA-A>API52,DSTAR\*;/002338h3437.38N/13534.29E>090/002/A=000012ID-52 OP.SATOH  
 ① ② ③ ④ ⑦ ⑧ ⑨ ⑩ ⑨ ⑪ ⑬ ⑭

◇Position (Base)

(e.g.) JA3YUA-A>API52,DSTAR\*;/002338h3437.38N/13534.29E-PHG5132OP.SATOH  
 ① ② ③ ④ ⑦ ⑧ ⑨ ⑩ ⑨ ⑫ ⑭

◇Object

(e.g.) JA3YUA-A>API52,DSTAR\*;:HAM FESTA\*012345z3437.38N\13534.29Eh2021.11.01 am10-pm4  
 ① ② ③ ④ ⑤ ⑥ ⑦ ⑧ ⑨ ⑩ ⑨ ⑭

◇Item

(e.g.) JA3YUA-A>API52,DSTAR\*;:REPEATER!3454.00N/13536.00E rPHG5132439.39MHz DV RPT JP3YHH A  
 ① ② ③ ④ ⑤ ⑥ ⑧ ⑨ ⑩ ⑨ ⑫ ⑭

◇Weather

(e.g.) JA3YUA-A>API52,DSTAR\*;/012345z3454.00N/13536.00E \_220/004g005t077r000p000P000h50b09900  
 ① ② ③ ④ ⑦ ⑧ ⑨ ⑩ ⑨ ⑮ ⑯ ⑰ ⑱ ⑲ ⑳ ㉑ ㉒

- ① Call sign
- ② SSID
- ③ Unproto Address
- ④ D-PRS Data type  
/ Position with time stamp  
! Position without time stamp  
; Object  
) Item
- ⑤ Object Name/Item Name
- ⑥ Data Type  
\* Live Object  
! Live Item  
\_ Killed Object/Killed Item
- ⑦ Time Stamp (UTC)  
h Hour Minute Second  
z Day Hour Minute
- ⑧ Latitude
- ⑨ Symbol
- ⑩ Longitude
- ⑪ Data Extension (Course/Speed)  
Course:0 ~ 360°  
Speed:0 ~ 999 knots

⑫ Data Extension(PHG codes)

PHG codes definitions

|                     | 0    | 1     | 2    | 3      | 4     | 5      | 6     | 7      | 8     | 9    |        |
|---------------------|------|-------|------|--------|-------|--------|-------|--------|-------|------|--------|
| First: Power        | 0    | 1     | 4    | 9      | 16    | 25     | 36    | 49     | 64    | 81   | (W)    |
| Second: Height      | 10   | 20    | 40   | 80     | 160   | 320    | 640   | 1280   | 2560  | 5120 | (feet) |
| Third: Gain         | 0    | 1     | 2    | 3      | 4     | 5      | 6     | 7      | 8     | 9    | (dB)   |
| Fourth: Directivity | omni | 45°NE | 90°E | 135°SE | 180°S | 225°SW | 270°W | 315°NW | 360°N | -    | -      |

- ⑬ Altitude  
-99999 ~ 999999 feet
- ⑭ Comment
- ⑮ Wind direction/Wind speed  
Wind direction:0 ~ 360°  
Wind speed: 0 ~ 999 mph
- ⑯ Gust speed  
0 ~ 999 mph
- ⑰ Temperature  
-99 ~ 999°F
- ⑱ Rainfall  
0.00 ~ 9.99 inch
- ⑲ Rainfall (24 Hours)  
0.00 ~ 9.99 inch
- ⑳ Rainfall (Midnight)  
0.00 ~ 9.99 inch
- ㉑ Humidity  
1 ~ 99%, 00=100%
- ㉒ Barometric pressure  
0.0 ~ 9999.9 hPa

## Transmitting NMEA data

Set a GPS sentence to transmit GPS data in the DV mode.

### ◇ Setting the GPS data sentence

[MENU] > GPS > GPS TX Mode > NMEA > **GPS Sentence**

1. Push [MENU].
2. Select "GPS TX Mode" in the "GPS" menu.
3. Select "NMEA."
4. Select "GPS Sentence."

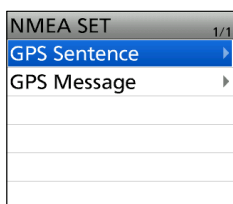

5. Select the GPS Sentence.

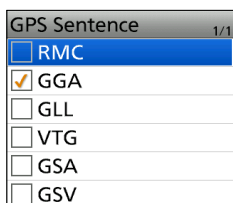

- Displays "☑" when the sentence is set to ON.
- ① The selectable GPS sentences are RMC, GGA, GLL, VTG, GSA, and GSV. The GGA sentence is set to ON as the default GPS sentence.
- ① To reset to the default setting, push [QUICK], and then select "Default."

6. Repeat step 5 to set the GPS sentence.
  - ① Up to 4 GPS sentences can be set at a time.
7. To close the "GPS Sentence" screen, push [MENU].
  - Returns to the standby screen, and then DV➤ is displayed.

#### NOTE:

- Set "GSV Sentence" to "OFF" when sending the GPS message to conventional digital transceivers. (p. 6-4)
- If "GPS Select" is set to "Manual," the transceiver automatically sets the NMEA sentence and transmits it along with the manually entered position data in "Manual Position."  
 ([MENU] > GPS > GPS Set > **GPS Select**)  
 ([MENU] > GPS > GPS Set > **Manual Position**)
- Note that if "GPS Auto TX" is set to any other option than "OFF," data is automatically transmitted according to the set time.  
 ([MENU] > GPS > **GPS Auto TX**)
  - ① If "GPS Select" is set to "OFF" or "Manual," the GPS Automatic Transmission function is not activated.

### Contents of GPS sentence

| Sentence | Lon /Lat | Alt | UTC | Date (UTC) | Status | 2D /3D | COG (True) | SOG (knot) | Others  |
|----------|----------|-----|-----|------------|--------|--------|------------|------------|---|
| RMC      | ✓        |     | ✓   | ✓          | ✓      |        | ✓          | ✓          | Magnetic variation, Mode Indicator  |
| GGA      | ✓        | ✓   | ✓   |            | ✓      |        |            |            | Number of satellites in use, HDOP, Geoidal separation, Age of Differential GPS data, Differential reference station ID              |
| GLL      | ✓        |     | ✓   |            | ✓      |        |            |            | Mode Indicator  |
| VTG      |          |     |     |            |        |        | ✓          | ✓          | COG (Magnetic north), SOG (km/h), Mode Indicator  |
| GSA      |          |     |     |            | ✓      | ✓      |            |            | PRN number of satellites used in solution, PDOP, HDOP, VDOP   |
| GSV      |          |     |     |            |        |        |            |            | Total number of sentences, Sentence number, Total number of satellites in view, Satellite information (ID, Elevation, Azimuth, S/N) |

## Transmitting NMEA data

### ◇ Setting a GPS message

Enter a GPS message to be transmitted with the position data.

Example: Entering “OSAKA Suzuki”

[MENU] > GPS > GPS TX Mode > NMEA > **GPS Message**

1. Push [MENU].
2. Select “GPS TX Mode” in the “GPS” menu.
3. Select “NMEA.”
4. Select “GPS Message.”

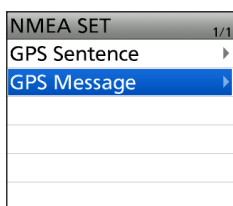

5. Push [QUICK].
6. Select “Edit.”

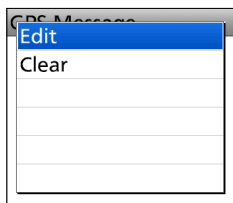

7. Enter a GPS message of up to 20 characters.

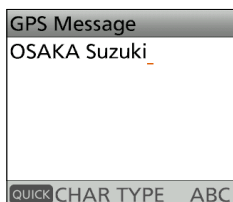

① See page iii on how to enter characters.

8. After entering, push [ENT].

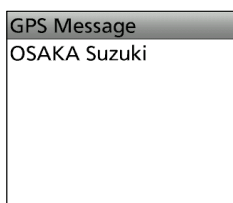

- You can confirm the entered message.

9. To close the “GPS Message” screen, push [MENU].

## GPS Automatic Transmission

### NOTE:

- Use the GPS Automatic Transmission function in only the Simplex mode.
- Using the function through a Repeater may interfere with other communications.

You can set the GPS Automatic Transmission function in the following menu.

[MENU] > GPS > **GPS Auto TX**

If you set this function, GPS data is automatically transmitted according to the set time.

- ① This function is not activated if your call sign (MY) is not entered in the transceiver.
- ① If “GPS Select” is set to “OFF” or “Manual,” this function is not activated.  
([MENU] > GPS > GPS Set > **GPS Select**)

## GPS Memory

You can add GPS data to GPS Memory. You can add your own position, other station's position, or any entered positions manually. You can save up to 300 GPS memories, and conveniently saved in up to 27 groups, from A ~ Z and "(No Group)." The A to Z groups can also be named.

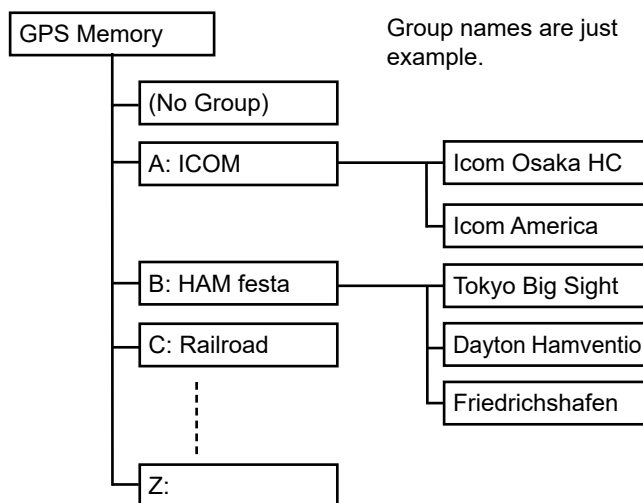

### ◇ Adding a GPS Memory

**Example:** Add "HOME" into (No Group).

#### 1. Adding a GPS Memory and entering the edit mode

[MENU] > GPS > **GPS Memory**

1. Push [MENU].
2. Select "GPS Memory" in the "GPS" menu.

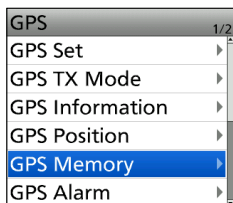

- The previously added GPS Memories are displayed on the GPS MEMORY screen.

3. Select "(No Group)."

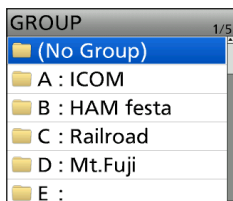

4. Push [QUICK].
5. Select "Add."

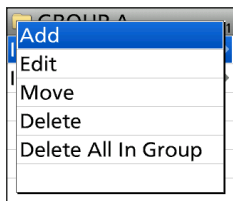

- The GPS MEMORY EDIT screen is displayed.

#### 2. Entering a GPS Memory name

1. Select "NAME."
2. Enter a GPS Memory name of up to 16 characters. (Example: HOME)

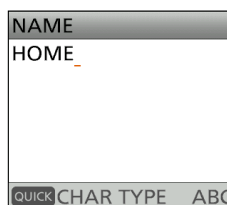

3. After entering, push [ENT].

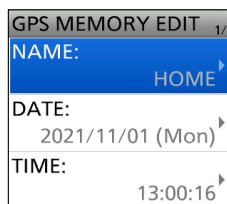

**TIP:** To edit the previously saved GPS Memory, select "Edit" in step 5. You can enter the content in the same way as described above.

## 6 GPS OPERATION (ADVANCED)

### GPS Memory

#### ◇ Adding a GPS Memory (Continued)

##### 3. Entering the GPS Memory date

1. Select "DATE."
2. Push D-pad(↔) to move the cursor.
3. Rotate [DIAL] to enter the date.  
① Set between 2000/01/02 and 2099/12/30.
4. Repeat steps 2 and 3 to enter the date.

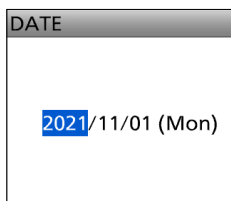

5. After entering, push [ENT].

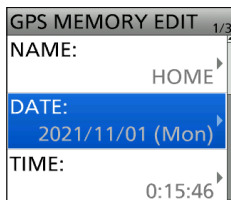

##### 4. Entering the GPS Memory time

1. Select "TIME."
2. Push D-pad(↔) to move the cursor.
3. Rotate [DIAL] to enter the date.  
① Set between 00:00:00 and 23:59:59.
4. Repeat steps 2 and 3 to enter the time.

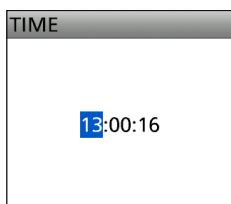

5. After entering, push [ENT].

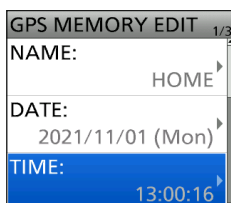

##### 5. Entering the GPS Memory latitude

1. Select "LATITUDE."
2. Push D-pad(↔) to move the cursor.
3. Rotate [DIAL] to enter the latitude.

###### ① Information

- Set between 0°00.00' and 90°00.00'.
- You can change the unit.  
([MENU] > SET > Display > Display Unit > **Latitude/Longitude**)
- To enter a north latitude, select "N," and to enter a south latitude, select "S."

4. Repeat steps 2 and 3 to enter the latitude.

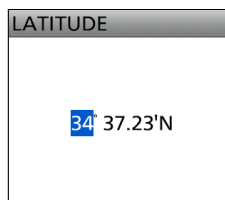

5. After entering, push [ENT].

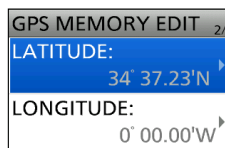

##### 6. Entering the GPS Memory longitude

1. Select "LONGITUDE."
2. Push D-pad(↔) to move the cursor.
3. Rotate [DIAL] to enter the longitude.

###### ① Information

- Set between 0°00.00' and 180°00.00'.
- You can change the unit.  
([MENU] > SET > Display > Display Unit > **Latitude/Longitude**)
- To enter an east longitude, select "E," and to enter a west longitude, select "W."

4. Repeat steps 2 and 3 to enter the longitude.

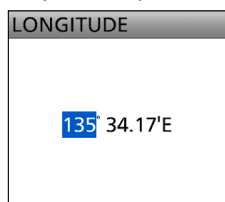

5. After entering, push [ENT].

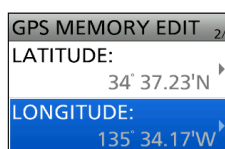

# 6 GPS OPERATION (ADVANCED)

## GPS Memory

### ◇ Adding a GPS Memory (Continued)

#### 7. Entering the GPS Memory altitude

1. Select "ALTITUDE."
2. Rotate [DIAL] to select plus or minus.
3. Push D-pad(↔) to move the cursor.
4. Rotate [DIAL] to enter the altitude.  
① Set between -32808 and +32808 feet.
5. Repeat steps 3 and 4 to enter the altitude.

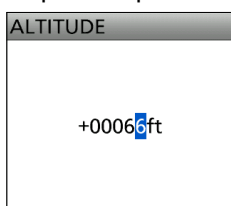

6. After entering, push [ENT].

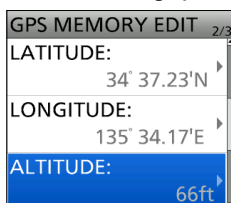

#### 8. Selecting a GPS Memory group

1. Select "GROUP."

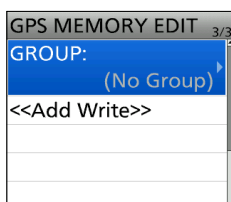

2. Select the group between (No Group) and A ~ Z.

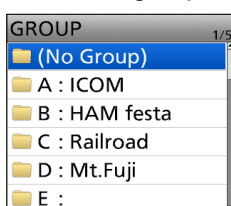

① You can save up to 300 Memories in each group.

#### 9. Writing the GPS Memory

1. Select "<<Add Write>>."

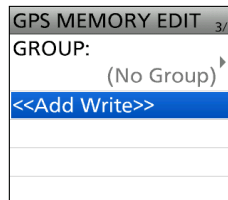

- The confirmation dialog is displayed.

① If you edit a previously added GPS Memory, select "<<Overwrite>>."

2. Select "YES."

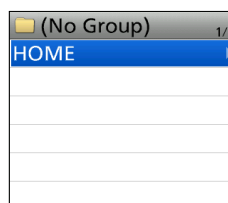
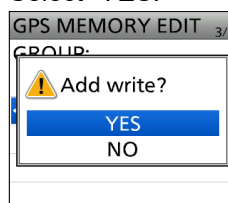

- The data is added to the GPS memory, and then the selected GPS Memory group screen is displayed.

① To exit the MENU screen, push [MENU].

#### TIP:

##### To view the entered content:

Select the GPS Memory channel. Rotate [DIAL] to check the whole content.

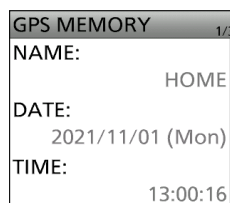

##### To cancel the entered data:

While entering or editing the GPS Memory, push [CLR] to display the confirmation dialog, as shown below. Select "YES" to cancel entering, and the display returns to the GPS Memory group screen.

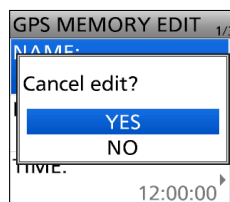

## GPS Memory

### ◇ Entering the GPS Memory group name

You can enter a name for each GPS Memory group.

[MENU] > GPS > **GPS Memory**

1. Push [MENU].
2. Select “GPS Memory” in the “GPS” menu.

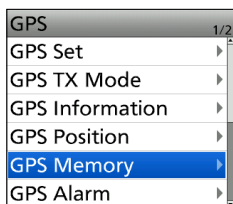

3. Select the group that the name to be entered.

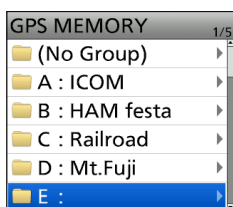

① **DO NOT** push [ENT].

4. Push [QUICK].
5. Select “Edit Name.”

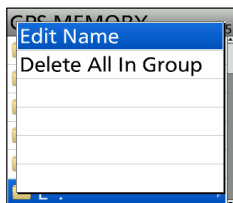

6. Enter a group name of up to 16 characters.



① See page iii on how to enter characters.

7. After entering, push [ENT].

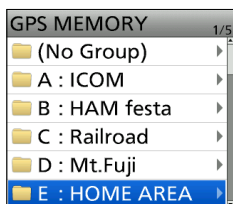

① To exit the MENU screen, push [MENU].

### ◇ Deleting the GPS Memory

You can delete the GPS Memories.

There are 2 ways to delete the Memories:

- Deletes all GPS Memory in a group.
- Deletes a specific GPS Memory.

**NOTE:** Deleted GPS Memories cannot be restored.

[MENU] > GPS > **GPS Memory**

**Example:** Deleting all in Group E.

1. Push [MENU].
2. Select “GPS Memory” in the “GPS” menu.
3. Select the group where the GPS Memory to delete is saved.

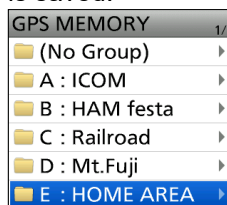

① **DO NOT** push [ENT].

4. Push [QUICK].
5. Select “Delete All In Group.”

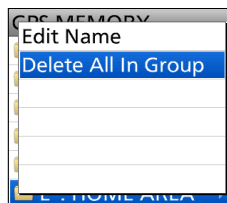

- The confirmation dialog is displayed.

6. Select “YES.”

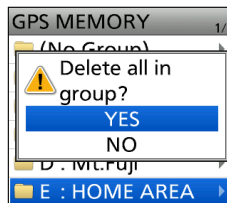

- All GPS Memory in the selected group are deleted, then returns to the GPS MEMORY screen.

① To exit the MENU screen, push [MENU].

#### **TIP: Deleting a specific GPS Memory**

1. Select the GPS Memory to delete, then push [QUICK].
2. Select “Delete.”

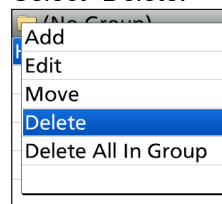

- The confirmation dialog is displayed.

3. Select “YES.”

  - The selected GPS Memory is deleted.

## GPS Memory

### ◇ Rearranging the display order of the GPS data

You can move the entered GPS Memories to rearrange their display order in the selected GPS Memory group.

① To move the GPS Memory out of their assigned Memory group, select the Memory group in the GPS MEMORY EDIT screen, and then save.

[MENU] > GPS > **GPS Memory**

1. Push [MENU].
2. Select "GPS Memory" in the "GPS" menu.

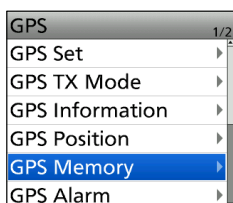

3. Select the group where the GPS Memory you want to move is saved.

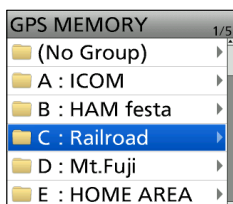

4. Select the GPS Memory to move, and then push [QUICK].



5. Select "Move."

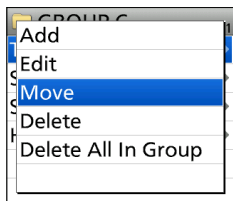

• "DESTINATION" blinks at the top left of the screen.

6. Select the position to insert the Memory you want to move.



• The selected Memory is inserted above the destination Memory name.

- ① If you select "<<Move End>>," the Memory is moved to the bottom of the group.
- ① To exit the MENU screen, push [MENU].

## GPS Alarm

The transceiver can sound a GPS Alarm when a target station or position comes into the alarm area. This function can be set to a caller station, all GPS Memories, a selected GPS Memory group, or a selected GPS Memory.

### Alarm Area (Group) (Setting plural stations)

When "All Memories" or a GPS Memory group is selected:

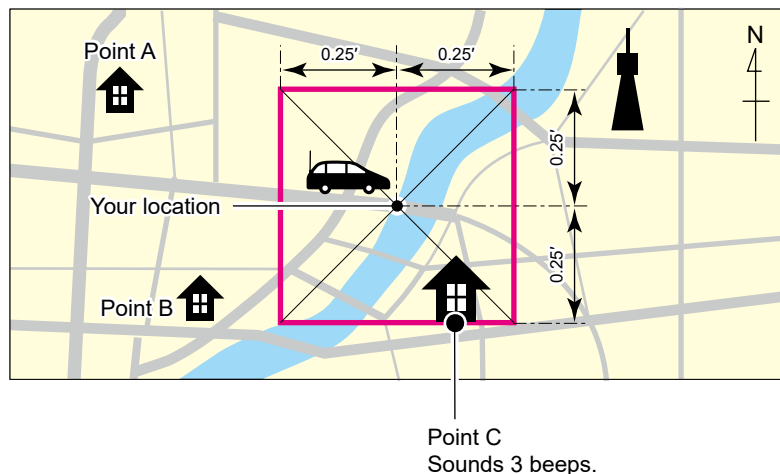

### Alarm Area (RX/Memory) (Setting specific station)

When a specific GPS Memory is selected:

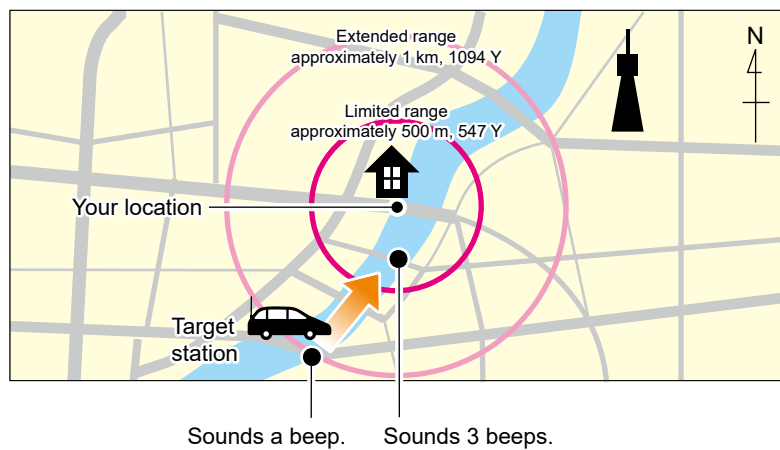

## GPS Alarm

### ◇ Setting the GPS Alarm function to All Memories (all GPS Memories)

[MENU] > GPS > **GPS Alarm**

1. Push [MENU].
2. Select "GPS Alarm" in the "GPS" menu.

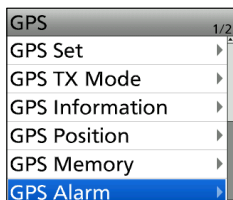

3. Select "Alarm Select."

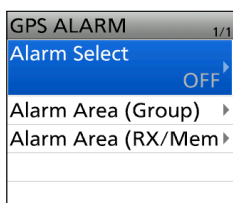

4. Select "Group."

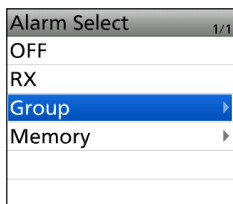

5. Select "All Memories."

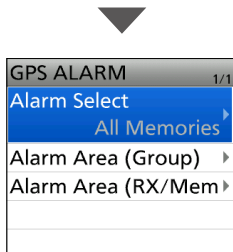
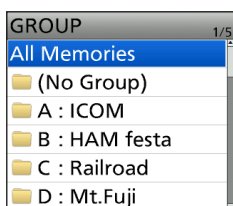

- Returns to the GPS ALARM screen.
- ① If you want to set the alarm to a specific GPS Memory group, select "(No Group)" or "A" to "Z."
- ① To exit the MENU screen, push [MENU].

#### ① Information

- When either one of the group's stations enters the set range, the alarm sounds 3 times.
- When the transceiver sounds a GPS Alarm, "GPS ALARM" is displayed on the screen, and "📶" blinks. See the illustration below.
- To cancel the GPS Alarm function, select "OFF" in step 4 to the left.

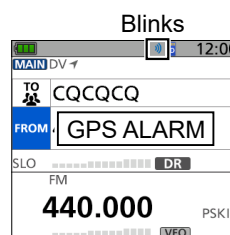

"GPS ALARM" is displayed on the screen and the alarm sounds 3 times.

**TIP:** When selecting "All Memories," "No Group," or a GPS Memory group (A ~ Z) in step 5 to the left, you also have to set "Alarm Area (Group)" to use the GPS Alarm function. (p. 6-43)  
 ([MENU] > GPS > GPS Alarm > **Alarm Area (Group)**)

## GPS Alarm

### ◇ Setting the GPS Alarm function to RX (a caller station)

[MENU] > GPS > **GPS Alarm**

1. Push [MENU].
2. Select “GPS Alarm” in the “GPS” menu.

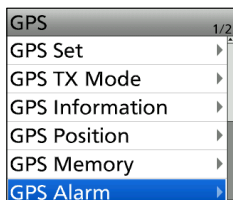

3. Select “Alarm Select.”

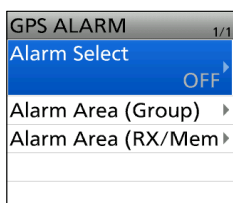

4. Select “RX.”

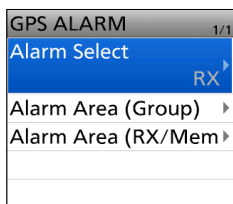
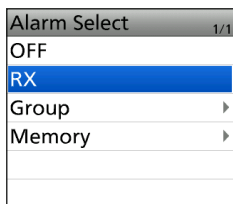

- Returns to the GPS ALARM screen.
- ① If you want to set the alarm to a specific GPS Memory group, select “Memory” and then select a GPS Memory in a GPS Memory group.
  - ① To exit the MENU screen, push [MENU].

#### ① Information

- When a station with its GPS Alarm set enters within an approximate 1 kilometer (1094 yards) range, it sounds once. When it enters within an approximate 500 meters (547 yards) range, the alarm sounds 3 times.
- When the transceiver sounds a GPS Alarm, “GPS ALARM” is displayed on the screen, and “🔊” blinks. See the illustration below.
- To cancel the GPS Alarm function, select “OFF” in step 4 to the left.

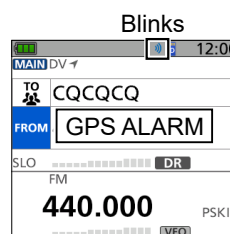

“GPS ALARM” is displayed on the screen and the alarm sounds 3 times.

**NOTE:** Even if “RX” is selected in step 4, when the received signal has no position data, the GPS Alarm does not sound.

**TIP:** When selecting “RX” or a specific GPS Memory in step 4 to the left, you also have to set the “Alarm Area (RX/Memory)” to use the GPS Alarm function. (p. 6-44)  
 ([MENU] > GPS > GPS Alarm > **Alarm Area (RX/Memory)**)

## GPS items

**NOTE:** The default settings shown below are for the USA transceiver version. The default settings may differ, depending on your transceiver version. To return to your transceiver version's default settings, push [QUICK] and select "Default."

### GPS Select (Default: ON)

[MENU] > GPS > GPS Set > **GPS Select**

Selects how to capture position data.

- ① When "GPS Time Correct" is set to "Auto," set this item to "ON" to automatically correct the time by a received GPS sentence. (p. 12-30)
- OFF: A GPS receiver is not used.
- ON: Position data of the internal GPS receiver is used for the GPS functions.
- Manual: Manually enter the current Latitude, Longitude, and Altitude in "Manual Position."

### SBAS (Default: OFF)

[MENU] > GPS > GPS Set > GPS Option > **SBAS**

Turns the SBAS (Satellite Based Augmentation System) function ON or OFF.

- ① When turning ON this function, the GPS position accuracy can be improved, but the transceiver's battery is quickly exhausted.
- OFF: Turns OFF the function.
- ON: Turns ON the function.

### GLONASS (Default: OFF)

[MENU] > GPS > GPS Set > GPS Option > **GLONASS**

Selects whether or not to use the data from the GLONASS (GLObal'naya NAVigatsionnaya Sputnikovaya Sistema) satellites.

- ① When turning ON this function, the GPS position accuracy can be improved, but the transceiver's battery is quickly exhausted.
- OFF: Does not use the data from the GLONASS satellites.
- ON: Uses the data from the GLONASS satellites.

### Power Save (Default: Auto)

[MENU] > GPS > GPS Set > GPS Option > **Power Save**

Selects whether or not to use the Power Save function for the internal GPS receiver.

When this function is ON, and if the GPS receiver does not receive signals from a satellite for 5 minutes, the function turns OFF the GPS receiver for this set period of time.

- OFF: The GPS receiver is always turned ON.
- 1, 2, 4, 8min:

When the receiver cannot receive signals from a satellite for 5 minutes, the GPS receiver is turned OFF for the selected period of time. (1, 2, 4, or 8 minutes). After this period, the receiver resumes receiving.

- Auto: When the receiver cannot receive signals from a satellite for 5 minutes, the GPS receiver is turned OFF for 1 minute. After this period, the receiver resumes receiving. The Power Save interval time extends to 2, 4, and then 8 minutes when receiving no signals for another 5 minutes, respectively.

### Satellite Information Out (Default: GPS/QZSS/GLONASS)

[MENU] > GPS > GPS Set > GPS Option > **Satellite Information Out**

Selects whether or not to output the data from the QZSS (Quasi-Zenith Satellite System) satellites and the GLONASS satellites.

- GPS/QZSS/GLONASS: Outputs the data from the GPS satellites, the QZSS satellites, and the GLONASS satellites.
- GPS Only: Outputs the data from only the GPS satellites.

### Manual Position (Default: LATITUDE: 0°00.00'N, LONGITUDE: 0°00.00'W, ALTITUDE: -----ft)

[MENU] > GPS > GPS Set > **Manual Position**

Manually enter the latitude, longitude, and altitude of your current position.

- ① You can capture position data from the GPS receiver if "Capture From GPS" is selected.

## GPS items

### GPS Out (USB Port) (Default: OFF)

[MENU] > GPS > GPS Set > **GPS Out (USB Port)**

Selects whether or not to output the position information to the USB port.

- OFF: Does not send the position information to the USB port.
- ON: Send the position information to the USB port.

### GPS TX Mode (Default: OFF)

[MENU] > GPS > **GPS TX Mode**

Selects a GPS transmission mode to send GPS position data while in the DV mode.

- OFF: Does not transmit GPS data.
- D-PRS: Transmits GPS data in the D-PRS format.
- NMEA: Transmits GPS data in the NMEA format.

### Unproto Address (Default: API52,DSTAR\*)

[MENU] > GPS > GPS TX Mode > D-PRS > **Unproto Address**

Displays an unproto address of up to 56 alphanumeric characters.

**NOTE:** You should use the default address, and editing is not recommended.

### Symbol (Default: Person)

[MENU] > GPS > GPS TX Mode > D-PRS > TX Format > Position > **Symbol**

Selects the symbol that indicates your operating situation. The selected symbol channel's symbols (1 ~ 4) are transmitted with position data.

#### <Editing a symbol with a 2 character symbol code>

1. Select a symbol channel.  
① **DO NOT** push [ENT].
2. Push [QUICK].
3. Select "Edit Symbol."
4. Push [QUICK].
5. Select "Direct Input."
6. Rotate [DIAL] to edit the first digit.
7. Push D-pad(→) to select the second digit.
8. Rotate [DIAL] to edit the second digit.

| Selectable characters and symbols   |
|---|
| <For the first digit> /, \, 0 to 9, A to Z  |
| <For the second digit> A to Z, a to z, 0 to 9, ! " # \$ % & ' ( ) * + , - . / : ; < = > ? @ [ \ ] ^ _ ` {   } ~ |

9. After editing, push [ENT].
  - Sets the symbol into the symbol channel selected in step 1.

#### <Selecting a preset symbol>

1. Select a symbol channel.  
① **DO NOT** push [ENT].
2. Push [QUICK].
3. Select "Edit Symbol."
4. Select a symbol.
  - Sets the symbol into the symbol channel selected in step 1.

## GPS items

### SSID (Default: ---)

[MENU] > GPS > GPS TX Mode > D-PRS > TX Format > Position > **SSID**

Selects an SSID based on APRS® to add to your call sign, to show your operating style to other stations.

- ① The SSID's additional methods differ, depending on whether the call sign includes a space or not.
- ---: The space in call sign is converted to "-."
  - ① If no text is entered after space, space will be deleted, and space is not converted to "-."
  - Example:** JA3YUA → JA3YUA  
JA3YUA A → JA3YUA-A
- (-0): No SSID is added.
  - ① If a call sign includes a space, any text or digit after space will be deleted.
  - Example:** JA3YUA → JA3YUA  
JA3YUA A → JA3YUA
- -1~-15: Adds an SSID of -1 to -15 to your call sign.
  - ① **Example:** SSID is "-9."  
JA3YUA → JA3YUA-9  
JA3YUA A → JA3YUA-9
- -A~-Z: Adds an SSID of -A to -Z to your call sign.
  - ① **Example:** SSID is "-Z."  
JA3YUA → JA3YUA-Z  
JA3YUA A → JA3YUA-Z

#### TIP: About the SSID

According to a common guideline, to help identify a station's type, designated call sign SSIDs are used in D-PRS (or APRS®).

The guideline may be changed when the infrastructure environment, such as a product or network, is changed. Check the latest guideline in the web site related to D-PRS and APRS® and correctly set.

<http://aprs.org/aprs11/SSIDs.txt>

### Comment

[MENU] > GPS > GPS TX Mode > D-PRS > TX Format > Position > **Comment**

Enter a comment to transmit it with the D-PRS position data.

You can enter up to four comments.

The number of characters you can enter differs, depending on the Data Extension and Altitude settings.

| Data Extension                | Altitude | Characters entered (maximum) |
|-------------------------------|----------|------------------------------|
| OFF                           | OFF      | 43 (Default)                 |
| OFF                           | ON       | 35                           |
| Course/Speed                  | OFF      | 36                           |
| Course/Speed                  | ON       | 28                           |
| Power/Height/Gain/Directivity | OFF      | 36                           |
| Power/Height/Gain/Directivity | ON       | 28                           |

The symbol "J" displays the transmittable comment range. Note that the characters that exceed the range will not be transmitted.

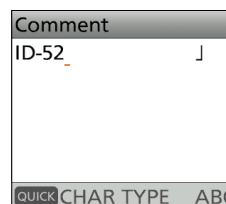

Transmittable comment range display (Example: up to 28 characters)

### Time Stamp (Default: OFF)

[MENU] > GPS > GPS TX Mode > D-PRS > TX Format > Position > **Time Stamp**

Selects the transmitting time stamp type.

The time stamp is transmitted with the position data in the D-PRS mode, and UTC (Universal Time Coordinated) time is used.

① When your position is manually set, time stamp data is not transmitted.

- OFF: Does not transmit the time information.
- DHM: Transmits the time stamp in the Day, Hour, and Minute format.
- HMS: Transmits the time stamp in the Hour, Minute, and Second format.

## GPS items

### Altitude (Default: OFF)

[MENU] > GPS > GPS TX Mode > D-PRS > TX Format > Position > **Altitude**

Selects whether or not to transmit altitude data with the position data in the D-PRS mode.

- ① The number of characters you can enter in "Comment" differs, depending on the "Altitude" and "Data Extension" settings.
- OFF: No altitude data is transmitted.
- ON: Transmits altitude data with position data.

### Data Extension (Default: OFF)

[MENU] > GPS > GPS TX Mode > D-PRS > TX Format > Position > **Data Extension**

Selects whether or not to transmit the Course/Speed data or the Power/Height/Gain/Directivity data with the position data in the D-PRS mode.

- ① The number of characters you can enter in "Comment" differs, depending on the "Altitude" and "Data Extension" settings.
- OFF: Does not transmit any information.
- Course/Speed:
  - Transmits the course and speed data with the position data.
  - ① The course and speed data are not transmitted when your location is manually set.
  - ① When transmitting with this setting, your station is regarded as a mobile station.
- Power/Height/Gain/Directivity:
  - Transmits the TX power level, height, antenna gain, antenna direction, and position data.
  - ① The Power, Height, Gain, and Directivity data are transmitted even if your location is manually set.
  - ① When transmitting with this setting, your station is regarded as a base station.

### Power (Default: 0W)

[MENU] > GPS > GPS TX Mode > D-PRS > TX Format > Position > **Power**

Selects the TX power level of the base station to transmit along with the position data.

- ① This item is displayed when "Data Extension" is set to "Power/Height/Gain/Directivity."
- Select 0, 1, 4, 9, 16, 25, 36, 49, 64, or 81 W.

### Height (Default: 10ft)

[MENU] > GPS > GPS TX Mode > D-PRS > TX Format > Position > **Height**

Selects the height of the base station's antenna to transmit along with the position data.

- ① This item is displayed when "Data Extension" is set to "Power/Height/Gain/Directivity."
- Select 10, 20, 40, 80, 160, 320, 640, 1280, 2560, or 5120 feet.\*
- \* If the Altitude/Distance unit is set to "m," select 3, 6, 12, 24, 49, 98, 195, 390, 780, or 1561 meters.

### Gain (Default: 0dB)

[MENU] > GPS > GPS TX Mode > D-PRS > TX Format > Position > **Gain**

Selects the gain of the base station's antenna to transmit along with the position data.

- ① This item is displayed when "Data Extension" is set to "Power/Height/Gain/Directivity."
- Select between 0 and 9 dB.

### Directivity (Default: Omni)

[MENU] > GPS > GPS TX Mode > D-PRS > TX Format > Position > **Directivity**

Selects the direction the base station's antenna was pointing to transmit along with the position data.

- ① This item is displayed when "Data Extension" is set to "Power/Height/Gain/Directivity."
- Select Omni, 45° NE, 90° E, 135° SE, 180° S, 225° SW, 270° W, 315° NW, or 360° N.

### Object Name

[MENU] > GPS > GPS TX Mode > D-PRS > TX Format > Object > **Object Name**

Sets an Object's name of up to 9 characters.

### Data Type (Default: Live Item)

[MENU] > GPS > GPS TX Mode > D-PRS > TX Format > Object > **Data Type**

Selects the Object's status.

- Live Item: The Item station is valid.
- Killed Item: The Item station is invalid.

### Symbol (Default: Transceiver)

[MENU] > GPS > GPS TX Mode > D-PRS > TX Format > Object > **Symbol**

The symbol is an icon that indicates the Object's means of transportation or location. The saved symbol is transmitted along with the position data while in the D-PRS mode.

- ① See page 6-31 for details of editing a symbol.

## 6 GPS OPERATION (ADVANCED)

### GPS items

#### Comment

[MENU] > GPS > GPS TX Mode > D-PRS > TX Format > Object > **Comment**

Enters a comment to transmit it with the D-PRS position data.

You can enter up to four comments.

The number of characters you can enter differs, depending on the Data Extension and Altitude settings.

| Data Extension                | Altitude | Characters entered (maximum) |
|-------------------------------|----------|------------------------------|
| OFF                           | —        | 43 (Default)                 |
| OFF                           | Entered  | 35                           |
| Course/Speed                  | —        | 36                           |
| Course/Speed                  | Entered  | 28                           |
| Power/Height/Gain/Directivity | —        | 36                           |
| Power/Height/Gain/Directivity | Entered  | 28                           |

The symbol “J” displays the transmittable comment range. Please note that the characters that exceed the range will not be transmitted.



Transmittable comment range display  
(Example: up to 28 characters)

#### Position

(Default: LATITUDE: 0°00.00'N,  
LONGITUDE: 0°00.00'W, ALTITUDE: -----ft)

[MENU] > GPS > GPS TX Mode > D-PRS > TX Format > Object > **Position**

Displays the position information of the Object.

Push [QUICK] to open the Quick Menu window shown below.

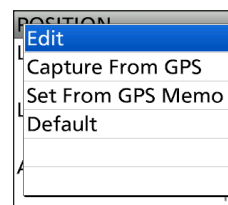

**TIP:** When you select “Capture From GPS” or “Set From GPS Memory,” you can capture the position from the GPS or set the Item’s position from the GPS memory.

#### Entering the position information manually

1. Select “Edit” on the Quick Menu window.
  - The POSITION EDIT screen is displayed.
2. Select “LATITUDE.”
3. Enter a latitude.
  - ① Select “N/S” to switch the north latitude and the southern latitude.
4. Select [ENT].
5. Select “LONGITUDE.”
6. Enter a longitude.
  - ① Select “E/W” to switch the east longitude and the west longitude.
7. Select [ENT].
8. Select “ALTITUDE.”
9. Enter an altitude.
  - ① After entering, select [+/-] to switch “+” and “-.”
10. Select [ENT].
11. Select “<<Write>>.”
12. Select “YES.”
  - The position information is entered.

## GPS items

### Data Extension (Default: OFF)

[MENU] > GPS > GPS TX Mode > D-PRS > TX Format > Object > **Data Extension**

Selects whether or not to transmit the Course/Speed data or the Power/Height/Gain/Directivity data with the position data in the D-PRS mode.

- ① The number of characters you can enter in "Comment" differs, depending on the "Altitude" and "Data Extension" settings.
- OFF: Does not transmit any information.
- Course/Speed: Transmits the course and speed data with the position data.
- Power/Height/Gain/Directivity: Transmits the TX power level, height, antenna gain, antenna direction, and position data.

### Course (Default: 0°)

[MENU] > GPS > GPS TX Mode > D-PRS > TX Format > Object > **Course**

Sets the Object's course to between 0° and 360°

- ① This item is displayed when "Data Extension" is set to "Course/Speed."

### Speed (Default: 0mph)

[MENU] > GPS > GPS TX Mode > D-PRS > TX Format > Object > **Speed**

Sets the Object's speed to between 0 and 1150 mph.\*  
\* If the Speed unit is set to "km/h," set to between 0 to 1850 km/h, or set to "knots," set to between 0 and 999 knots.

- ① This item is displayed when "Data Extension" is set to "Course/Speed."

### Power (Default: 0W)

[MENU] > GPS > GPS TX Mode > D-PRS > TX Format > Object > **Power**

Selects the TX power level of Object to transmit along with the position data.

- ① This item is displayed when "Data Extension" is set to "Power/Height/Gain/Directivity."
- Select 0, 1, 4, 9, 16, 25, 36, 49, 64, or 81 W.

### Height (Default: 10ft)

[MENU] > GPS > GPS TX Mode > D-PRS > TX Format > Object > **Height**

Selects the height of the Object's antenna to transmit along with the position data.

- ① This item is displayed when "Data Extension" is set to "Power/Height/Gain/Directivity."
- Select 10, 20, 40, 80, 160, 320, 640, 1280, 2560, or 5120 feet.\*
- \* If the Altitude/Distance unit is set to "m," select 3, 6, 12, 24, 49, 98, 195, 390, 780, or 1561 meters.

### Gain (Default: 0dB)

[MENU] > GPS > GPS TX Mode > D-PRS > TX Format > Object > **Gain**

Selects the gain of the Object's antenna to transmit along with the position data.

- ① This item is displayed when "Data Extension" is set to "Power/Height/Gain/Directivity."
- Select between 0 and 9 dB.

### Directivity (Default: Omni)

[MENU] > GPS > GPS TX Mode > D-PRS > TX Format > Object > **Directivity**

Selects the direction the Object's antenna was pointing to transmit along with the position data.

- ① This item is displayed when "Data Extension" is set to "Power/Height/Gain/Directivity."
- Select Omni, 45° NE, 90° E, 135° SE, 180° S, 225° SW, 270° W, 315° NW, or 360° N.

### SSID (Default: ---)

[MENU] > GPS > GPS TX Mode > D-PRS > TX Format > Object > **SSID**

Selects an SSID based on APRS® to add to your call sign, to show your operating style to other stations.

- ① The SSID's additional methods differ, depending on whether the call sign includes a space or not.
- ① See page 6-32 for details of the SSID.
- ---: The space in call sign is converted to "-."
- (-0): No SSID is added.
- -1 ~ -15: Adds an SSID of -1 to -15 to your call sign.
- -A ~ -Z: Adds an SSID of -A to -Z to your call sign.

### Time Stamp (Default: OFF)

[MENU] > GPS > GPS TX Mode > D-PRS > TX Format > Object > **Time Stamp**

Selects the transmitting time stamp type.

The time stamp is transmitted with the position data in the D-PRS mode, and UTC (Universal Time Coordinated) time is used.

- ① When your position is manually set, time stamp data is not transmitted.
- DHM: Transmits the time stamp in the Day, Hour, and Minute format.
- HMS: Transmits the time stamp in the Hour, Minute, and Second format.

## 6 GPS OPERATION (ADVANCED)

### GPS items

#### Item Name

[MENU] > GPS > GPS TX Mode > D-PRS > TX Format > Item > **Item Name**

Sets the Item station's name of up to 9 characters.

#### Data Type (Default: Live Item)

[MENU] > GPS > GPS TX Mode > D-PRS > TX Format > Item > **Data Type**

Selects the Item station's status.

- Live Item: The Item station is valid.
- Killed Item: The Item station is invalid.

#### Symbol (Default: Transceiver)

[MENU] > GPS > GPS TX Mode > D-PRS > TX Format > Item > **Symbol**

Selects the symbol that indicates the Item's means of transportation or location. The selected symbol channel's symbols are transmitted with position data while in the D-PRS mode.

① See page 6-31 for details of editing a symbol.

#### Comment

[MENU] > GPS > GPS TX Mode > D-PRS > TX Format > Item > **Comment**

Enters a comment to transmit it with the D-PRS position data.

The number of characters you can enter differs, depending on the Data Extension and Altitude settings.

| Data Extension                | Altitude | Characters entered (maximum) |
|-------------------------------|----------|------------------------------|
| OFF                           | —        | 43 (Default)                 |
| OFF                           | Entered  | 35                           |
| Course/Speed                  | —        | 36                           |
| Course/Speed                  | Entered  | 28                           |
| Power/Height/Gain/Directivity | —        | 36                           |
| Power/Height/Gain/Directivity | Entered  | 28                           |

The symbol “J” displays the transmittable comment range. Please note that the characters that exceed the range will not be transmitted.

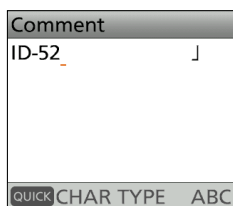

Transmittable comment range display  
(Example: up to 28 characters)

#### Position

(Default: LATITUDE: 0°00.00'N,  
LONGITUDE: 0°00.00'W, ALTITUDE: -----ft)

[MENU] > GPS > GPS TX Mode > D-PRS > TX Format > Item > **Position**

Displays the position information of the Item.

Push [QUICK] to open the Quick Menu window shown below.

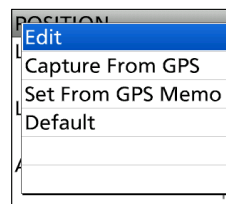

**TIP:** When you select “Capture From GPS” or “Set From GPS Memory,” you can capture the position from the GPS or set the Item's position from the GPS memory.

① See page 6-34 when you want to enter the position information manually.

#### Data Extension (Default: OFF)

[MENU] > GPS > GPS TX Mode > D-PRS > TX Format > Item > **Data Extension**

Selects whether or not to transmit the Course/Speed data or the Power/Height/Gain/Directivity data with the position data in the D-PRS mode.

① The number of characters you can enter in “Comment” differs, depending on the settings.

- OFF: Does not transmit any information.
- Course/Speed: Transmits the course and speed data with the position data.
- Power/Height/Gain/Directivity: Transmits the TX power level, height, antenna gain, antenna direction, and position data.

#### Course (Default: 0°)

[MENU] > GPS > GPS TX Mode > D-PRS > TX Format > Item > **Course**

Sets the Item's course to between 0° and 360°

① This item is displayed when “Data Extension” is set to “Course/Speed.”

#### Speed (Default: 0°)

[MENU] > GPS > GPS TX Mode > D-PRS > TX Format > Item > **Speed**

Sets the Item's speed to between 0 and 1150 mph.\*

\* If the Speed unit is set to “km/h,” set to between 0 to 1850 km/h, or set to “knots,” set to between 0 and 999 knots.

① This item is displayed when “Data Extension” is set to “Course/Speed.”

## 6 GPS OPERATION (ADVANCED)

### GPS items

#### **Power** (Default: 0W)

[MENU] > GPS > GPS TX Mode > D-PRS > TX Format > Item > **Power**

Selects the TX power level of Item, to transmit along with the position data.

① This item is displayed when "Data Extension" is set to "Power/Height/Gain/Directivity."

- Select 0, 1, 4, 9, 16, 25, 36, 49, 64, or 81 W.

#### **Height** (Default: 10ft)

[MENU] > GPS > GPS TX Mode > D-PRS > TX Format > Item > **Height**

Selects the height of the Item's antenna to transmit along with the position data.

① This item is displayed when "Data Extension" is set to "Power/Height/Gain/Directivity."

- Select 10, 20, 40, 80, 160, 320, 640, 1280, 2560, or 5120 feet.\*

\* If the Altitude/Distance unit is set to "m," select 3, 6, 12, 24, 49, 98, 195, 390, 780, or 1561 meters.

#### **Gain** (Default: 0dB)

[MENU] > GPS > GPS TX Mode > D-PRS > TX Format > Item > **Gain**

Selects the gain of the Item's antenna to transmit along with the position data.

① This item is displayed when "Data Extension" is set to "Power/Height/Gain/Directivity."

- Select between 0 and 9 dB.

#### **Directivity** (Default: Omni)

[MENU] > GPS > GPS TX Mode > D-PRS > TX Format > Item > **Directivity**

Selects the direction the Item's antenna was pointing to transmit along with the position data.

① This item is displayed when "Data Extension" is set to "Power/Height/Gain/Directivity."

- Select Omni, 45° NE, 90° E, 135° SE, 180° S, 225° SW, 270° W, 315° NW, or 360° N.

#### **SSID** (Default: ---)

[MENU] > GPS > GPS TX Mode > D-PRS > TX Format > Item > **SSID**

Selects an SSID based on APRS® to add to your call sign, to show your operating style to other stations.

① The SSID's additional methods differ, depending on whether the call sign includes a space or not.

② See page 6-32 for details of the SSID.

- ---: The space in call sign is converted to "-."
- (-0): No SSID is added.
- -1 ~ -15: Adds an SSID of -1 to -15 to your call sign.
- -A ~ -Z: Adds an SSID of -A to -Z to your call sign.

## 6 GPS OPERATION (ADVANCED)

### GPS items

#### **Symbol** (Default: WX Station)

[MENU] > GPS > GPS TX Mode > D-PRS > TX Format > Weather > **Symbol**

The symbol is an icon that indicates the weather station's means of transportation or location.

The saved symbol is transmitted along with the position data while in the D-PRS mode.

① See page 6-31 for details of editing a symbol.

#### **SSID** (Default: ---)

[MENU] > GPS > GPS TX Mode > D-PRS > TX Format > Weather > **SSID**

Selects an SSID based on APRS® to add to your call sign, to show your operating style to other stations.

① The SSID's additional methods differ, depending on whether the call sign includes a space or not.

① See page 6-32 for details of the SSID.

- ---: The space in call sign is converted to "-."
- (-0): No SSID is added.
- -1 ~ -15: Adds an SSID of -1 to -15 to your call sign.
- -A ~ -Z: Adds an SSID of -A to -Z to your call sign.

#### **Comment**

[MENU] > GPS > GPS TX Mode > D-PRS > TX Format > Weather > **Comment**

Enter a comment to transmit it with the D-PRS position data, up to 43 characters.

#### **Time Stamp** (Default: OFF)

[MENU] > GPS > GPS TX Mode > D-PRS > TX Format > Weather > **Time Stamp**

Selects the transmitting time stamp type.

The time stamp is transmitted with the position data in the D-PRS mode, and UTC (Universal Time Coordinated) time is used.

- OFF: Does not transmit the time information.
- DHM: Transmits the time stamp in the Day, Hour, and Minute format.
- HMS: Transmits the time stamp in the Hour, Minute, and Second format.

## 6 GPS OPERATION (ADVANCED)

### GPS items

#### GPS Sentence (Default: GGA)

[MENU] > GPS > GPS TX Mode > NMEA > **GPS Sentence**

Selects sentences to be transmitted in the GPS mode to transmit position data. Set to between RMC, GGA, GLL, VTG, GSA, and GSV.

**NOTE:** Set the GSV sentence to OFF when sending the GPS message to conventional digital transceivers. (p. 6-4)  
The GSV sentence is incompatible with them.

#### Information

- Up to 4 GPS sentences can be set at a time.
- Displays "☑" when the sentence is set to ON.
- "VTG," "GSA," and "GSV" sentences are not transmitted when your position has been manually set.

#### GPS Message

[MENU] > GPS > GPS TX Mode > NMEA > **GPS Message**

Enter a GPS message of up to 20 alphanumeric characters. (p. 6-21)

**NOTE:** When you do not want to send a message, delete the entered message.

#### GPS Information

[MENU] > GPS > **GPS Information**

Displays the GPS satellite direction, elevation angle, satellite number, and receiving status. (p. 6-11)

#### TIP: Contents of GPS sentence

The Time Stamp is displayed based on the UTC (Universal Time Coordinated) time.

| Sentence | Lon/Lat   | Alt | GPS Time Stamp (UTC) | Date (UTC) | Status | 2D/3D | COG (True) | SOG (knot) |
|----------|---|-----|----------------------|------------|--------|-------|------------|------------|
| RMC      | ✓   |     | ✓                    | ✓          | ✓      |       |            | ✓          |
| GGA      | ✓   | ✓   | ✓                    |            | ✓      |       |            |            |
| GLL      | ✓   |     | ✓                    |            | ✓      |       |            |            |
| VTG      |   |     |                      |            |        |       | ✓          | ✓          |
| GSA      |   |     |                      |            | ✓      | ✓     |            |            |
| GSV      |   |     |                      |            |        |       |            |            |
| Sentence | Others  |     |                      |            |        |       |            |            |
| RMC      | Magnetic variation, Mode Indicator  |     |                      |            |        |       |            |            |
| GGA      | Number of satellites in use, HDOP, Geoidal separation, Age of Differential GPS data, Differential reference station ID              |     |                      |            |        |       |            |            |
| GLL      | Mode Indicator  |     |                      |            |        |       |            |            |
| VTG      | COG (Magnetic north), SOG (km/h), Mode Indicator  |     |                      |            |        |       |            |            |
| GSA      | PRN number of satellites used in solution, PDOP, HDOP, VDOP   |     |                      |            |        |       |            |            |
| GSV      | Total number of sentences, Sentence number, Total number of satellites in view, Satellite information (ID, Elevation, Azimuth, S/N) |     |                      |            |        |       |            |            |

## GPS items

### GPS Position

[MENU] > GPS > **GPS Position**

Your current position, received position, GPS Memory, or GPS Alarm position information is displayed.

(p. 6-6)

Rotating [DIAL] to select the MY, RX, MEM, and ALM screens.

#### MY screen (MY Position)

|           |   |
|-----------|---|
| Compass*  | Displays your direction.  |
| Course    | Displays your direction heading.  |
| Latitude  | Displays your latitude.   |
| Longitude | Displays your longitude.  |
| GL        | Displays the grid locator based on the latitude and longitude of your location. |
| ALT       | Displays your own altitude.   |
| SPEED     | Displays your speed over the ground.  |
| TIME      | Displays current time received from the GPS.                                    |

① When "GPS Select" is set to "Manual," the screen displays only latitude, longitude, altitude, GL (Grid locator), and time (internal clock).

#### RX screen (Received position data of the other station)

Depending on the caller's TX mode or TX format, the displayed items and these meanings are different. The following lists describe the items for each category.

No data is displayed when no position data is received on your transceiver.

#### <1. When the caller's TX mode is NMEA>

|                |   |
|----------------|---|
| Compass*       | Displays the caller's direction from your location.                                     |
| Latitude       | Displays the caller's latitude.   |
| Longitude      | Displays the caller's longitude.  |
| GL             | Displays the grid locator based on the latitude and longitude of the caller's location. |
| ALT            | Displays the caller's altitude.   |
| DST            | Displays the caller's distance from your location.                                      |
| Call sign      | Displays the caller's call sign.  |
| COURSE         | Displays the caller's direction over the ground.  |
| SPEED          | Displays the caller's speed.  |
| GPS Time Stamp | Displays the time that the caller acquired the position data.                           |

#### <2. When the caller's TX format is D-PRS Position (Mobile station)>

|                |   |
|----------------|---|
| Compass*       | Displays the caller's direction from your location.                                     |
| Symbol         | Displays the caller's D-PRS symbol.   |
| Latitude       | Displays the caller's latitude.   |
| Longitude      | Displays the caller's longitude.  |
| GL             | Displays the grid locator based on the latitude and longitude of the caller's location. |
| ALT            | Displays the caller's altitude.   |
| DST            | Displays the caller's distance from your location.                                      |
| Call sign      | Displays the caller's call sign (with SSID).  |
| COURSE         | Displays the caller's direction over the ground.  |
| SPEED          | Displays the caller's speed.  |
| GPS Time Stamp | Displays the time that the caller acquired the position data.                           |

\* You can change the display type in the Quick Menu window.

## 6 GPS OPERATION (ADVANCED)

### GPS items

#### GPS Position (continued)

##### <3. When the caller's TX format is D-PRS Position (Base station)>

|                |   |
|----------------|---|
| Compass*       | Displays the caller's direction from your location.                                     |
| Symbol         | Displays the caller's D-PRS symbol.   |
| Latitude       | Displays the caller's latitude.   |
| Longitude      | Displays the caller's longitude.  |
| GL             | Displays the grid locator based on the latitude and longitude of the caller's location. |
| ALT            | Displays the caller's altitude.   |
| DST            | Displays the caller's distance from your location.                                      |
| Call sign      | Displays the caller's call sign (with SSID).  |
| POWER          | Displays the caller's TX power level.   |
| HEIGHT         | Displays the caller's antenna height.   |
| GAIN           | Displays the caller's antenna gain.   |
| DIRECT         | Displays the direction of the caller's antenna was pointing.                            |
| GPS Time Stamp | Displays the time that the caller acquired the position data.                           |

##### <4. When the caller's TX format is D-PRS Object/Item>

|                  |  |
|------------------|--|
| Compass*         | Displays the Object/Item's direction from your location.                                     |
| Symbol           | Displays the Object/Item's D-PRS symbol.   |
| Latitude         | Displays the Object/Item's latitude.   |
| Longitude        | Displays the Object/Item's longitude.  |
| GL               | Displays the grid locator based on the latitude and longitude of the Object/Item's location. |
| ALT              | Displays the Object/Item's altitude.   |
| DST              | Displays the Object/Item's distance from your location.                                      |
| Object/Item name | Displays the Object/Item's name.   |
| Call sign        | Displays the caller's call sign (with SSID).   |
| COURSE           | Displays the Object/Item's direction over the ground.  |
| SPEED            | Displays the Object/Item's speed.  |
| POWER            | Displays the Object/Item's TX power level.   |
| HEIGHT           | Displays the Object/Item's antenna height.   |
| GAIN             | Displays the Object/Item's antenna gain.   |
| DIRECT           | Displays the direction that the Object/Item's antenna was pointing.                          |
| GPS Time Stamp   | Displays the time that the caller sent the Object's data.                                    |

① When the Object or Item is disabled, "KILLED" is displayed.

\* You can change the display type in the Quick Menu window.

## 6 GPS OPERATION (ADVANCED)

### GPS items

#### GPS Position (continued)

##### <5. When the caller's TX format is D-PRS Weather>

|                |   |
|----------------|---|
| Compass*       | Displays the caller's direction from your location.                                     |
| Symbol         | Displays the caller's D-PRS symbol.   |
| Latitude       | Displays the caller's latitude.   |
| Longitude      | Displays the caller's longitude.  |
| GL             | Displays the grid locator based on the latitude and longitude of the caller's location. |
| DST            | Displays the caller's distance from your location.                                      |
| Call sign      | Displays the caller's call sign (with SSID).  |
| Temperature    | Displays the temperature of the caller station's area.                                  |
| Humidity       | Displays the humidity of the caller station's area.                                     |
| RAIN           | Displays the rainfall of the caller station's area.                                     |
| WIND DIR       | Displays the wind direction of the caller station's area.                               |
| WIND SPD       | Displays the wind speed of the caller station's area.                                   |
| BARO           | Displays the barometric pressure of the caller station's area.                          |
| GPS Time Stamp | Displays the time that the caller acquired the position data.                           |

##### MEM screen (GPS memory position)

|                 |  |
|-----------------|--|
| Compass*        | Displays GPS Memory channel's direction from your location.                              |
| Latitude        | Displays GPS Memory channel's latitude.  |
| Longitude       | Displays GPS Memory channel's longitude.   |
| GL              | Displays the grid locator based on the latitude and longitude of the GPS Memory channel. |
| DST             | Displays GPS Memory channel's distance from your location.                               |
| GPS memory name | Displays the caller's call sign (with SSID).   |

① You can change the GPS Memory in the Quick Menu window.

##### ALM screen (GPS alarm position)

|           |  |
|-----------|--|
| Compass*  | Displays GPS Alarm area's direction from your location.  |
| Latitude  | Displays GPS Alarm area's latitude.  |
| Longitude | Displays GPS Alarm area's longitude.   |
| GL        | Displays the grid locator based on the latitude and longitude of the GPS Alarm area.           |
| DST       | Displays the GPS Alarm area's distance from your location.                                     |
| GPS Alarm | Displays "RX," GPS memory group name, or GPS memory name specified for the GPS Alarm function. |

① You can change the GPS Alarm in the Quick Menu window.

\* You can change the display type in the Quick Menu window.

## GPS items

### GPS Memory

[MENU] > GPS > **GPS Memory**

The transceiver has 300 GPS memories to save the received position data, or often-used position data, with an alphanumeric memory name. The channels can be divided into the “(No Group)” group and each Memory group (A to Z) for easy Memory management.

#### The display of the GPS MEMORY screen

|                   |  |
|-------------------|--|
| (No Group)        | GPS Memories not assigned to any group       |
| A ~ Z: Group Name | GPS Memories assigned to the selected group. |

#### GPS Memory Groups (A ~ Z)

|            |  |
|------------|--|
| GROUP NAME | GPS Memory Group name (Up to 16 alphanumeric characters) |
|------------|--|

① You can edit the GPS Memory Group name. (p. 6-25)

#### GPS Memories

|           |  |
|-----------|--|
| NAME      | GPS memory name (Up to 16 alphanumeric characters) |
| DATE      | Saved date   |
| TIME      | Saved time   |
| LATITUDE  | Saved position (latitude)                          |
| LONGITUDE | Saved position (longitude)                         |
| ALTITUDE  | Saved altitude                                     |
| GROUP     | The group letter and the name of the group         |

- ① When you save the received position data on the GPS POSITION screen, the received station’s call sign is used as the GPS Memory name.
- ① In the Quick Menu window, you can edit the GPS Memory contents, such as the GPS Memory name.

### Alarm Select

(Default: OFF)

[MENU] > GPS > GPS Alarm > **Alarm Select**

Selects the target positions for the GPS Alarm function.

- OFF: Turns OFF the function.
- RX: The GPS Alarm sounds when a target (the last received position) enters your active alarm range.
- Group: The GPS Alarm sounds when a target (positions in the GPS Memory, or the selected GPS Memory Group) enters your active alarm range.
- Memory: The GPS Alarm sounds when a target (the entered position in the GPS Memory) enters your active alarm range.

### Alarm Area (Group)

(Default: 0.25’)

[MENU] > GPS > GPS Alarm > **Alarm Area (Group)**

Sets the GPS active alarm range.

When a target enters this set active alarm range, the GPS Alarm sounds, and the GPS Alarm icon blinks.

① When “Alarm Select” is set to “Group,” this setting is enabled.

Ranges differ, depending on the Latitude/Longitude unit setting.

- Latitude/Longitude = ddd°mm.mm’  
Ranges: 00.08’ to 59.99’ (0.01’ steps)
  - Latitude/Longitude = ddd°mm’mm”  
Ranges: 00’05” to 59’59” (0’01” steps)
  - Latitude/Longitude = ddd.dddd°  
Ranges: 0.0014° to 0.9999° (0.0001° steps)
- ① Pushing D-pad(↔) moves the cursor to the tenths and hundredths place digits, or the thousandths and ten thousandths place digits.

#### Example:

When a target enters the active alarm range, the GPS Alarm sounds, and the GPS alarm icon blinks.

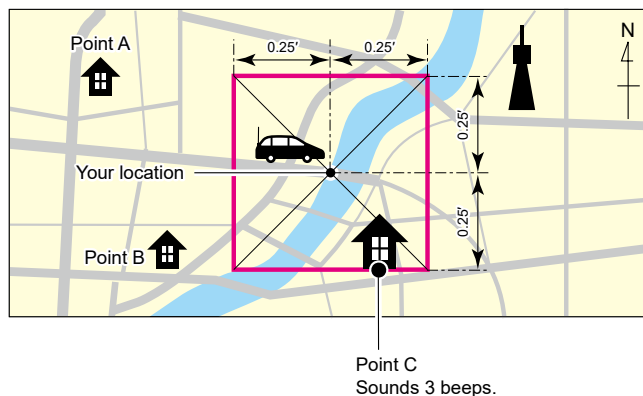

## 6 GPS OPERATION (ADVANCED)

### GPS items

#### Alarm Area (RX/Memory) (Default: Both)

[MENU] > GPS > GPS Alarm > Alarm Area (RX/Memory)

Selects the GPS active alarm range.

When a target enters the active alarm range, the GPS Alarm sounds, and the GPS alarm icon blinks.

① When "Alarm Select" is set to "RX" or "Memory," this setting is enabled. (p. 6-43)

- Limited: The transceiver sounds 3 beeps, and the GPS Alarm icon blinks when the target enters the 500 meters range.
- Extended: The transceiver sounds 3 beeps, and the GPS Alarm icon blinks when the target enters the 1-kilometer range.
- Both: The transceiver sounds a beep, and the GPS Alarm icon blinks when the target enters the 1-kilometer range and sounds 3 beeps, and the icon blinks when it enters the 500 meters range. When the target exits the 500 meters range but is still in the 1-kilometer range, the icon continues to blink, but no beeps sound.

#### Example:

When a target station enters the active alarm range (500 meters or 1 kilometer range, depending on the setting), the GPS Alarm sounds, and the GPS Alarm icon blinks.

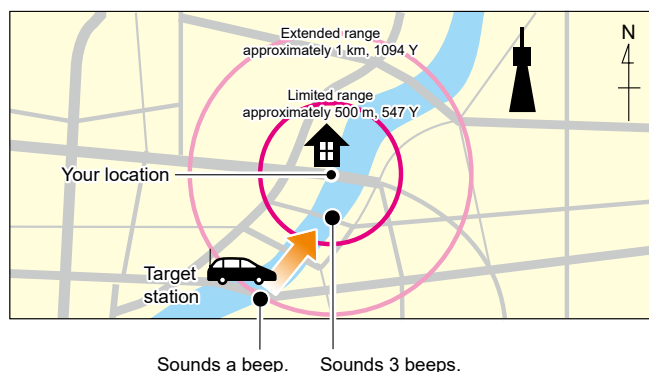

#### GPS Logger (Default: ON)

[MENU] > GPS > GPS Logger

Turns the GPS Logger function ON or OFF.

This function logs the position, altitude, course, speed, and number of satellites being used.

- OFF: Turns OFF the function.
- ON: The transceiver automatically logs GPS data. Once this function is turned ON, the GPS data will be continuously logged until turning it OFF, even if the transceiver power is turned OFF, then ON again.

① This function requires a microSD card (User supplied).

① When "GPS select" is set to "OFF" or "Manual," this function does not save the log.

**TIP:** The log data is saved on the microSD card. The file name is automatically created, as shown below:

- Log start date and time: 1st November 2021 15:30:00
- Filename: 20211101\_153000.csv

#### Record Interval (Default: 10sec)

[MENU] > GPS > GPS Logger > Record Interval

Sets the GPS Logger function record interval to 1, 5, 10, 30 seconds, or 1, 5, or 10 minutes.

#### Record Sentence

(Default:  RMC/  GGA/  VTG/  GSA)

[MENU] > GPS > GPS Logger > Record Sentence

Sets the GPS Logger function record sentence to RMC, GGA, VTG, or GSA.

- Displays "" when the sentence is set.

**NOTE:** Select at least one sentence, otherwise an error beep will sound.

#### <<GPS Logger Only>>

[MENU] > GPS > GPS Logger > <<GPS Logger Only>>

You can turn ON the GPS Logger Only mode.

Only the GPS Logger is functioning in this mode, and the transceiver does not transmit or receive it.

#### ① Information

- **BE SURE** to insert a microSD card.
- Set "GPS Select" to "ON." (p. 6-30)
- To cancel the mode, restart the transceiver.

---

## 6 GPS OPERATION (ADVANCED)

### GPS items

#### **GPS Auto TX** (Default: OFF)

##### [MENU] > GPS > **GPS Auto TX**

Selects an option for the GPS automatic transmission function.

This function automatically transmits the current position data received from a GPS receiver and any entered GPS message at the set interval.

- OFF: Does not automatically transmit the position data. (When you push [PTT], the transceiver transmits the position data.)
- 30 sec to 30 min:  
Transmits the current position data at the selected interval (30 seconds, or 1, 3, 5, 10, or 30 minutes).

# Section 7 VOICE TX FUNCTION

---

**NOTE:** See the Basic manual Section 6 for details on how to insert or remove a microSD card and precautions.

|   |     |
|---|-----|
| Voice TX function.....                        | 7-2 |
| ◇ Recording the voice audio.....              | 7-2 |
| ◇ Transmitting the recorded voice audio ..... | 7-3 |
| VOICE items.....                              | 7-4 |

## Voice TX function

The Voice TX function transmits the recorded audio that is on the microSD card, one time or repeatedly, for up to 10 minutes at the set interval.

This function is convenient to repeatedly call CQ, or for other events.

You can assign the [Voice TX] key function to an optional microphone key or optional Bluetooth headset. (pp. 12-18, 12-34)

**NOTE: BE SURE** to insert a microSD card into the transceiver.

### ◇ Recording the voice audio

[MENU] > VOICE > Record

1. Push [MENU].
2. Select "VOICE."
3. Select "Record."

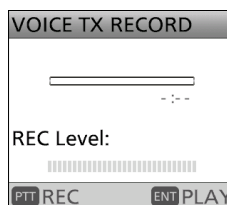
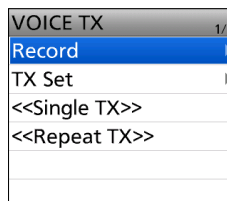

4. Hold down [PTT] to record.

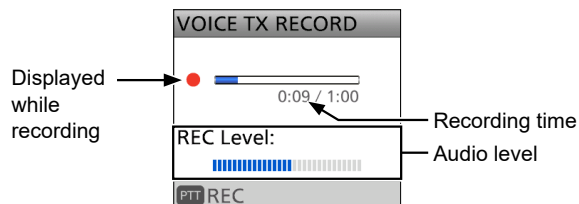

#### ① Information

- Hold the microphone 5 ~ 10 cm (2 ~ 4 inches) from your mouth, then speak at your normal voice level.
- The maximum record time is 1 minute.
- Only 1 voice memory can be recorded.

**TIP:** On the VOICE TX RECORD screen, push [QUICK], then select "Clear" to clear the recorded audio.

5. Push [ENT] to confirm the recorded voice.
  - The voice is played back.

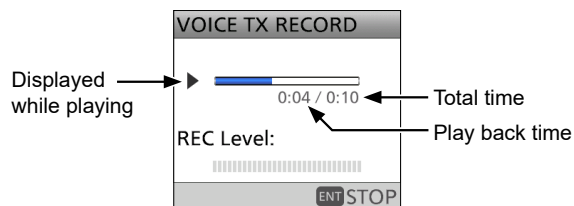

- ① If you hold down [PTT], the recording starts again. In this case, the previous recorded audio will be overwritten.
- ① To exit the MENU screen, push [MENU].

## Voice TX function

### ◇ Transmitting the recorded voice audio

**NOTE: BE SURE** to insert a microSD card into the transceiver.

[MENU] > VOICE > <<Single TX>>

[MENU] > VOICE > <<Repeat TX>>

1. Push [MENU].
2. Select "VOICE."
3. Select "<<Single TX>>" or "<<Repeat TX>>."
  - <<Single TX>>:  
The recorded voice audio is transmitted only once.

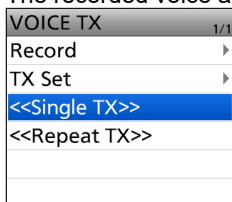

- <<Repeat TX>>:  
The recorded voice audio is repeatedly transmitted.

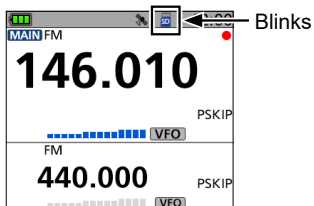
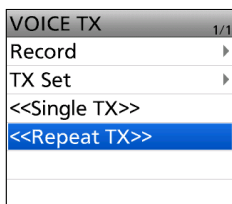

Blinks

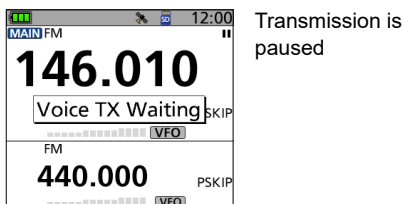

Transmission is paused

#### ① Information

- While transmitting, the SD card icon blinks.
- When you select "<<Repeat TX>>," the transceiver repeatedly transmits the recorded voice audio for up to 10 minutes at the interval set in "Repeat Time."  
([MENU] > VOICE > TX Set > Repeat Time)

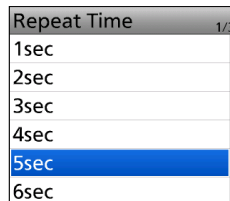

- Any of the following action cancels the transmission.
  - Pushing [PTT]
  - Turning OFF the transceiver, then turning it ON again.
  - Pushing any key (except for [VOL] and [P])
- After the second transmission, the transmission continues pausing, if receiving a signal, even if "Busy Lockout" is set to "ON."  
([MENU] > SET > Function > Busy Lockout)  
However, if the squelch is manually opened in the FM mode, the voice audio is repeatedly transmitted, according to the "Repeat Time" setting.
- You can select whether or not to output the TX voice audio from the speaker.  
([MENU] > VOICE > TX Set > TX Monitor)

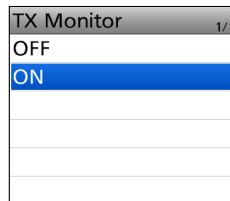

**TIP:** To transmit the recorded voice audio in the Quick Menu window, push [QUICK], then select "Voice TX."

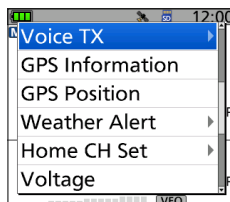

## VOICE items

### Record

[MENU] > VOICE > **Record**

Up to 1 minute of audio can be recorded onto a microSD card for voice transmission. (p. 7-2)

The transceiver can save only 1 voice audio.

① **BE SURE** to insert a microSD card.

② While recording a QSO, you cannot use this function.

### Repeat Time

(Default: 5sec)

[MENU] > VOICE > TX Set > **Repeat Time**

Sets the Repeat Time to between 1 and 15 seconds (in 1 second steps).

The transceiver repeatedly transmits the recorded voice audio for this set interval.

**NOTE:** The recorded voice audio is repeatedly transmitted for up to 10 minutes. If 10 minutes passes while transmitting, the transceiver continues to transmit until the complete voice audio transmission is finished.

### TX Monitor

(Default: ON)

[MENU] > VOICE > TX Set > **TX Monitor**

Turns the TX Monitor function ON or OFF.

- OFF: The TX voice audio is not heard from the speaker.
- ON: The TX voice audio is heard from the speaker.

### <<Single TX>>

[MENU] > VOICE > <<**Single TX**>>

The transceiver transmits the recorded voice audio only once.

① You can also select "Single TX" in the Quick Menu window.

([QUICK] > Voice TX > **Single TX**)

### <<Repeat TX>>

[MENU] > VOICE > <<**Repeat TX**>>

The transceiver repeatedly transmits the recorded voice audio for up to 10 minutes, according to the "Repeat Time" setting.

#### ① Information

- You can also select "Repeat TX" in the Quick Menu window.  
([QUICK] > Voice TX > **Repeat TX**)
- If 10 minutes passes while transmitting, the transceiver continues to transmit until the complete voice audio transmission is finished.
- Any of the following action cancels the transmission.
  - Pushing [PTT]
  - Turning OFF the transceiver, then turning it ON again.
  - Pushing any key (except for [VOL] and [⏻])

# Section 8

# RECORDER FUNCTION

---

**NOTE:** See the Basic manual Section 6 for details on how to insert or remove a microSD card and precautions.

|   |      |
|---|------|
| Recording a QSO audio .....                     | 8-2  |
| Playing back a recorded audio .....             | 8-3  |
| Changing the QSO recorder settings .....        | 8-4  |
| Deleting the audio folder/file .....            | 8-5  |
| ◇ Deleting an audio folder .....                | 8-5  |
| ◇ Deleting an audio file .....                  | 8-6  |
| Viewing the file information.....               | 8-7  |
| Using the Voice Recorder function .....         | 8-9  |
| ◇ To start recording.....                       | 8-9  |
| ◇ Playing back a recorded audio .....           | 8-10 |
| ◇ Deleting an audio folder .....                | 8-11 |
| ◇ Deleting an audio file.....                   | 8-12 |
| ◇ Viewing the file information.....             | 8-13 |
| Playing back the recorded audio on the PC ..... | 8-14 |
| RECORD items .....                              | 8-15 |

## Recording a QSO audio

### NOTE:

- You must insert a microSD card into the transceiver before recording audio.
- The recording function is continuously ON, even if the transceiver is turned OFF then ON again.

### To start recording

1. Push [QUICK].
2. Select “<<REC Start>>.”



- “Recording started.” is displayed, then returns to the standby screen.

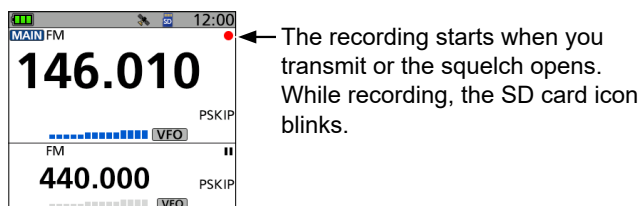
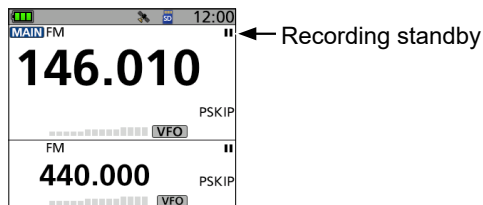

### Information

- The recording pauses while no signal is received, and resumes when a signal is received again.
- The recording continues until you manually stop recording, or the card becomes full.
- If the recording file's content reaches 2GB, the transceiver automatically creates a new file, and continues recording.

### To stop recording

1. Push [QUICK].
2. Select “<<REC Stop>>.”



### TIP:

- You can select to record the received audio from only the MAIN band or both the MAIN and SUB bands. (p. 8-15)  
([MENU] > RECORD > QSO Recorder > Recorder Set > **REC Operation**)
- When “RX REC Condition” is set to “Always,” the recording automatically starts when “<<REC Start>>” is selected. In that case, recording continues, even when no signal is received.\* (p. 8-15)  
([MENU] > RECORD > QSO Recorder > Recorder Set > **RX REC Condition**)  
\* The recorded file contains no sound.

## Playing back a recorded audio

**NOTE:** Insert the microSD card that contains the recorded audio file into the transceiver's slot.

[MENU] > RECORD > QSO Recorder > **Play Files**

1. Push [MENU].
2. Select "RECORD."
3. Select "QSO Recorder."

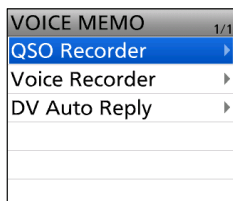

4. Select "Play Files."

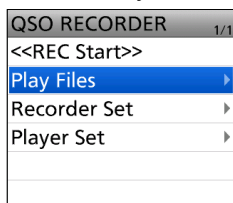

5. Select the folder that contains the audio file to play.

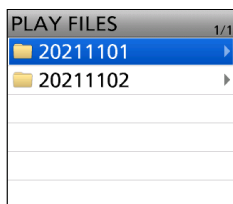

① The folder is named in the following format:  
 yyyyymmdd (yyyy: year, mm: month, dd: day)

6. Select the audio file to play.

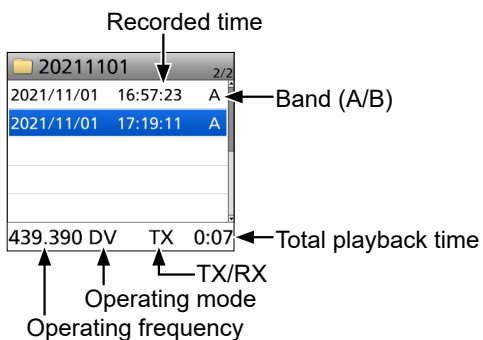

- The VOICE PLAYER screen is displayed, and the file starts to play.

**TIP: Selecting the record file type to display.**  
 In step 6, push [QUICK], then select "Display File" and select the record file type to display.

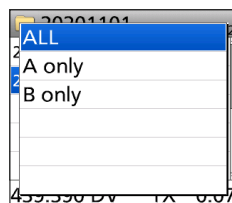

- ALL: Displays all recorded files.
- A only: Displays only the audio file that was recorded on the A band.
- B only: Displays only the audio file that was recorded on the B band.

### The VOICE PLAYER screen description

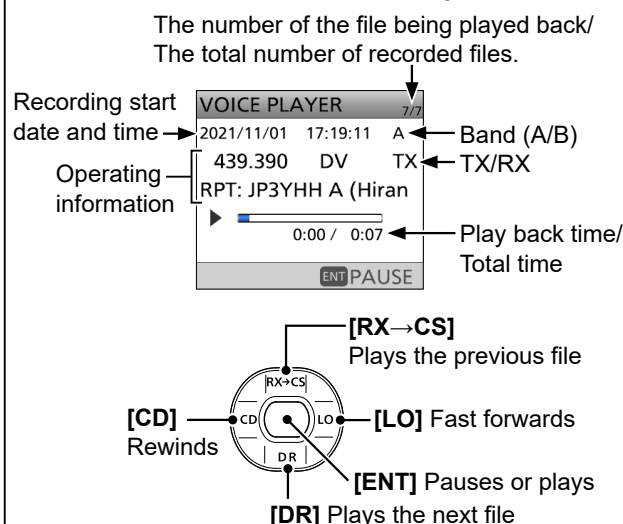

### Fast forward [LO]/Rewind [CD]

- Hold down to continuously fast forward, or rewind the file.
- The default skip time is 10 seconds. If you want to change it, see page 8-16 for details.
- You can fast forward or rewind the file by rotating [DIAL]. The fast forward/rewind time is 1/20 of the total file time, regardless of the skip time setting.
- If you push [CD] within the first 1 second of the file, the end of the previous file is played back.

### Playing the previous file [RX→CS]

- While the oldest file in the folder is playing back, pushing [RX→CS] plays back the same file.
- While the file is paused, pushing [RX→CS] moves to the beginning of the previous file.

### Playing the next file [DR]

While the latest file in the folder is playing back, pushing [DR] plays back the same file.

### Operating information

The operating frequency, mode, and audio category (RX/TX audio) are displayed.

## Changing the QSO recorder settings

You can change the recording settings.  
See pages 8-15 and 8-16 for details.

### Continue to record, even while the squelch is closed

[MENU] > RECORD > QSO Recorder > Recorder Set > **RX REC Condition**

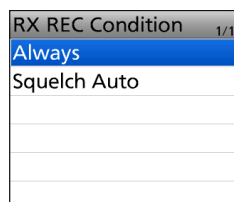

① The default setting is "Squelch Auto" (Records only while the squelch is open).

### Record the QSO audio as one file

[MENU] > RECORD > QSO Recorder > Recorder Set > **File Split**

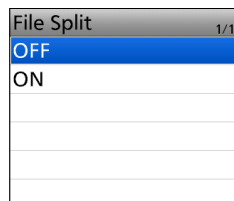

- ① The default setting is "ON" (transmit and receive audio are separately recorded in different files).
- ① When "RX REC Condition" is set to "Squelch Auto," an audio file is created every time the squelch opens. The received audio is recorded in a separated file.

### Separately start or stop recording on the selected band (MAIN band)

[MENU] > RECORD > QSO Recorder > Recorder Set > **REC Operation**

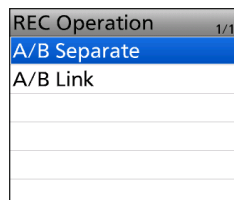

① The default setting is "A/B Link" (recording simultaneously starts on the MAIN and SUB bands).

### Synchronize the recording to PTT

[MENU] > RECORD > QSO Recorder > Recorder Set > **PTT Auto REC**

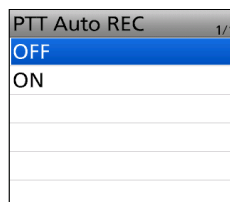

① The default setting is "ON" (Recording is synchronized to PTT).

#### TIP: When "PTT Auto REC" is set to "ON"

- Starts recording not only when [PTT] is pushed, but also when switched to transmit by a speaker microphone or a Bluetooth headset, by a CI-V command, or by the VOX function.
- A signal that is received within 10 seconds after the squelch is closed is recorded in the same file.

### Change the Skip Time

[MENU] > RECORD > QSO Recorder > Player Set > **Skip Time**

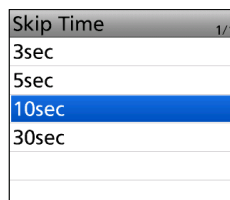

① The default setting is "10sec."

## Deleting the audio folder/file

**NOTE:** A deleted audio file can NOT be recovered.

### ◇ Deleting an audio folder

**NOTE:** All audio files in the folder are deleted.

[MENU] > RECORD > QSO Recorder > **Play Files**

1. Push [MENU].
2. Select "RECORD."
3. Select "QSO Recorder."

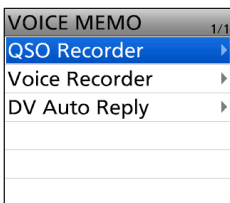

4. Select "Play Files."



5. Select the folder to delete.

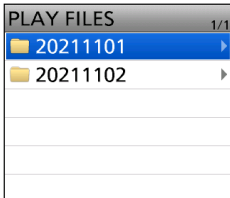

① **DO NOT** push [ENT].

6. Push [QUICK].
7. Select "Delete."

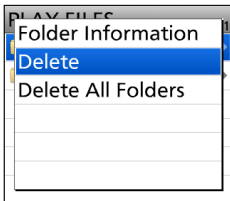

- The confirmation dialog is displayed.

8. Select "YES."

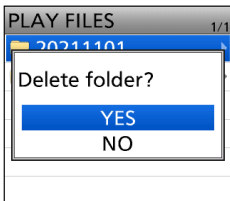

- The folder is deleted.

① To exit the MENU screen, push [MENU].

**TIP: To delete all folders**  
Select "Delete All Folders" in step 7.

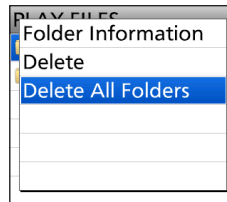

## Deleting the audio folder/file

### ◇ Deleting an audio file

[MENU] > RECORD > QSO Recorder > **Play Files**

1. Push [MENU].
2. Select "RECORD."
3. Select "QSO Recorder."

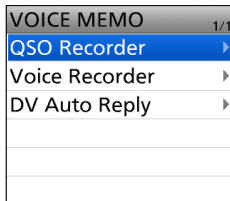

4. Select "Play Files."



5. Select the folder that contains the audio file to delete.

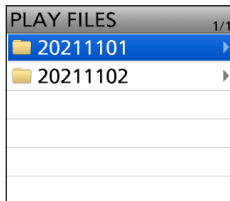

6. Select the audio file to delete.



ⓘ **DO NOT** push [ENT].

7. Push [QUICK].
8. Select "Delete."

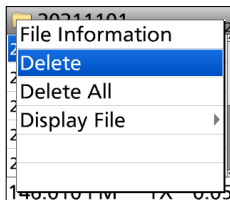

- The confirmation dialog is displayed.

9. Select "YES."

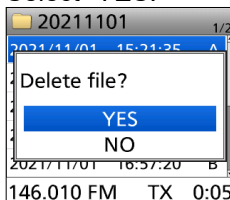

- The file is deleted.

ⓘ To exit the MENU screen, push [MENU].

#### TIP: To delete all files

Select "Delete All" in step 8.

ⓘ If "Display File" is set to "A only" or "B only," only displayed files are deleted.

- "Display File" is "ALL"

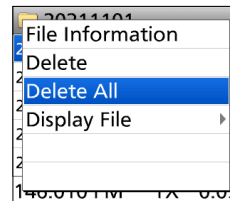

- "Display File" is "A only"

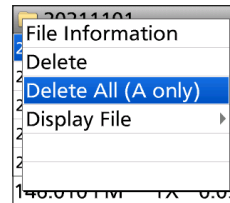

- "Display File" is "B only"

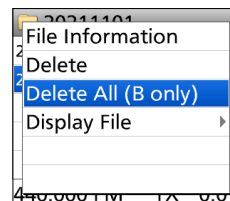

## Viewing the file information

The recorded audio file contains the recording data.  
See page 8-8 for the recorded contents.

[MENU] > RECORD > QSO Recorder > **Play Files**

1. Push [MENU].
2. Select "RECORD."
3. Select "QSO Recorder."

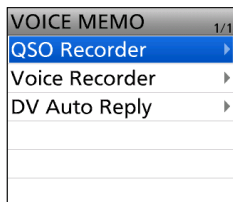

4. Select "Play Files."



5. Select the folder that contains the audio file to view the information.

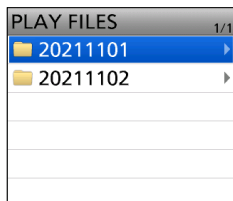

6. Select the audio file to view the information.



ⓘ **DO NOT** push [ENT].

7. Push [QUICK].

8. Select "File Information."

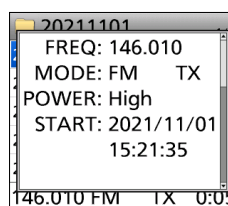
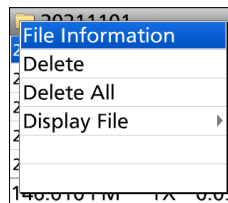

9. Rotate [DIAL] to change the screen.  
ⓘ To exit the MENU screen, push [MENU].

### TIP: To view the folder information

Push [QUICK] in step 5, and then select "Folder Information" to view the folder information.

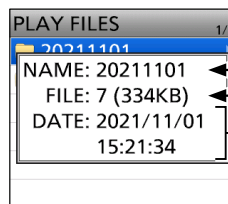
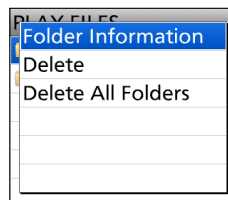

← Folder name  
← Total files (total size)  
← Created date and time

## Viewing the file information

### File information examples

① Depending on the recording status, some data may not be displayed.

① The file is named in the following format: `yyyymmdd_hhmmss`

(yyyy: year, mm: month, dd: day, hh: hour, mm: minute, ss: second)

#### • TX audio file information

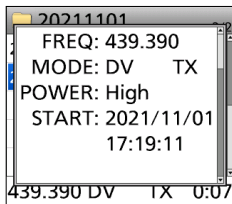

Operating information (TX)  
Recording date and time

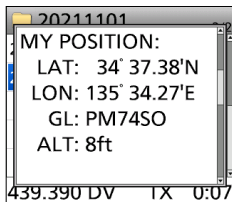

MY station position

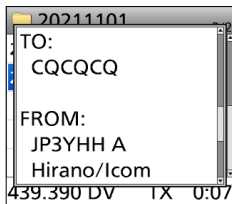

DR setting

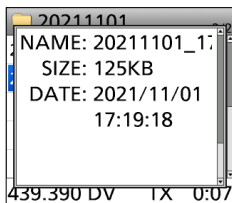

File data

#### • RX audio file information

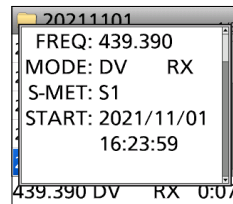

Operating information (RX)  
Recording date and time

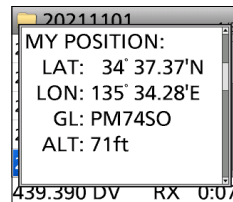

MY station position

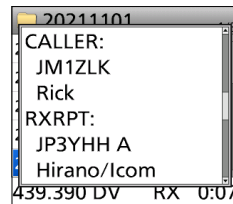

Caller and received repeater

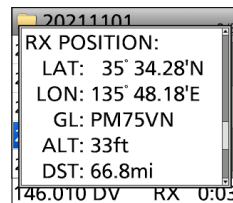

RX station position

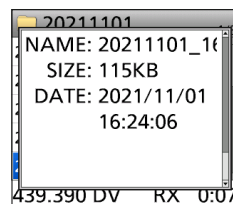

File data

## Using the Voice Recorder function

The microphone audio, including audio from an external microphone, can be recorded for your convenience.

**NOTE:** You must insert a microSD card into the transceiver before recording audio.

### ◇ To start recording

**NOTE:** You cannot record a voice while recording a QSO. In that case, push [QUICK] in the standby screen, and then select “Stop Recording” to stop the QSO recording.

[MENU] > RECORD > Voice Recorder > **Record**

1. Push [MENU].
2. Select “RECORD.”
3. Select “Voice Recorder.”

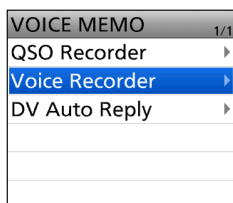

4. Select “Record.”



← Remaining time  
← Microphone gain level

- The VOICE RECORDER screen is displayed.

- ① Depending on the microSD card capacity, you may continuously record up to a maximum of about 37 hours. If the file size exceeds 2 GB, a new file is automatically created in the same folder, and the recorded voice audio is saved there.

5. Push [PTT] to start recording.
  - The microphone audio recording starts.

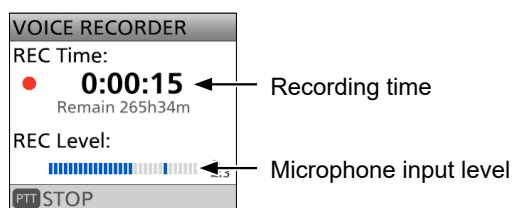

← Recording time  
← Microphone input level

6. Push [PTT] again to stop.
  - ① To exit the MENU screen, push [MENU].

**TIP:** Even if the external microphone or Bluetooth headset is connected, the internal microphone’s voice audio is recorded when the transceiver’s [PTT] is pushed. To record the external microphone’s voice audio, hold down the external microphone’s [PTT]. To record the Bluetooth headset’s voice audio, hold down the Bluetooth headset’s [PTT].

**To change the microphone gain level**  
Push [QUICK] in the VOICE RECORDER screen, and then select “MIC Gain.”

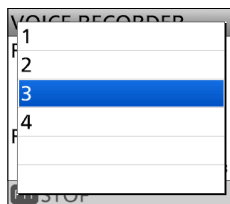
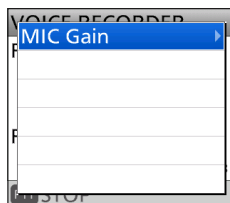

## Using the Voice Recorder function

### ◇ Playing back a recorded audio

**NOTE:** You cannot play back a recorded audio while recording a QSO. In that case, push [QUICK] in the standby screen, and then select “Stop Recording” to stop the QSO recording.

[MENU] > RECORD > Voice Recorder > **Play Files**

1. Push [MENU].
2. Select “RECORD.”
3. Select “Voice Recorder.”

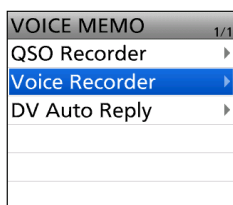

4. Select “Play Files.”



5. Select the folder that contains the audio file to play.

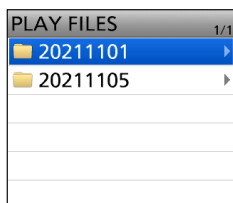

① The folder is named in the following format:  
 yyyyymmdd (yyyy: year, mm: month, dd: day)

6. Select the audio file to play.

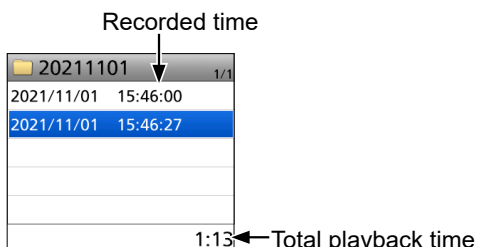

- The VOICE PLAYER screen is displayed, and the file starts to play.

### The VOICE PLAYER screen description

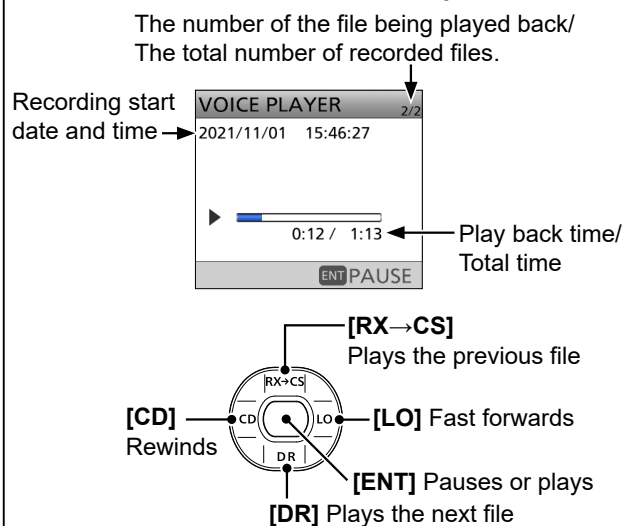

### Fast forward [LO]/Rewind [CD]

- Hold down to continuously fast forward or rewind the file.
- The default skip time is 10 seconds. If you want to change it, see page 8-16 for details.
- You can fast forward or rewind the file by rotating [DIAL]. The fast forward/rewind time is 1/20 of the total file time, regardless of the skip time setting.
- If you push [CD] within the first 1 second of the file, at the end of the previous file is played back.

### Playing the previous file [RX→CS]

- While the oldest file in the folder is playing back, pushing [RX→CS] plays back the same file.
- While the file is paused, pushing [RX→CS] moves to the beginning of the previous file.

### Playing the next file [DR]

While the latest file in the folder is playing back, pushing [DR] plays back the same file.

## Using the Voice Recorder function

### ◇ Deleting an audio folder

#### NOTE:

- All audio files in the folder are deleted.
- A deleted audio file can NOT be recovered.

[MENU] > RECORD > Voice Recorder > **Play Files**

1. Push [MENU].
2. Select "RECORD."
3. Select "Voice Recorder."

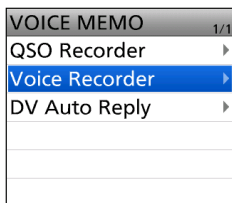

4. Select "Play Files."



5. Select the folder to delete.

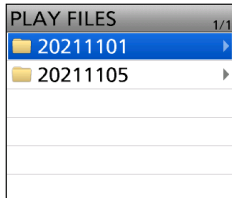

ⓘ **DO NOT** push [ENT].

6. Push [QUICK].
7. Select "Delete."

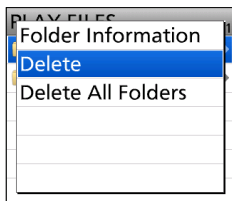

- The confirmation dialog is displayed.

8. Select "YES."

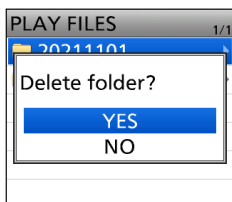

- The folder is deleted.

ⓘ To exit the MENU screen, push [MENU].

#### TIP: To delete all folders

Select "Delete All Folders" in step 7.

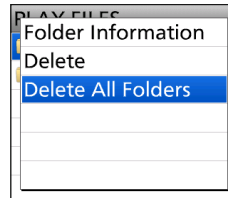

## Using the Voice Recorder function

### ◇ Deleting an audio file

**NOTE:** A deleted audio file can NOT be recovered.

[MENU] > RECORD > Voice Recorder > **Play Files**

1. Push [MENU].
2. Select "RECORD."
3. Select "Voice Recorder."

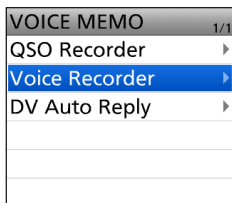

4. Select "Play Files."



5. Select the folder that contains the audio file to delete.

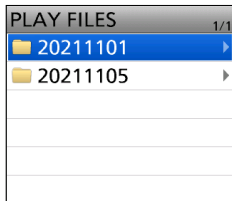

6. Select the audio file to delete.

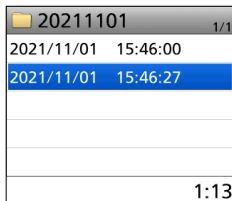

ⓘ **DO NOT** push [ENT].

7. Push [QUICK].
8. Select "Delete."

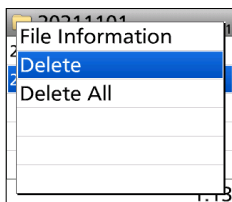

• The confirmation dialog is displayed.

9. Select "YES."

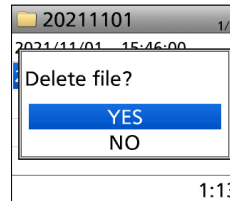

• The file is deleted.

ⓘ To exit the MENU screen, push [MENU].

**TIP: To delete all files**  
Select "Delete All" in step 8.

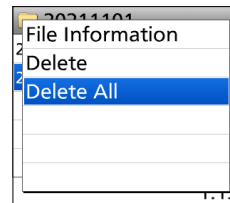

## Using the Voice Recorder function

### ◇ Viewing the file information

[MENU] > RECORD > Voice Recorder > **Play Files**

1. Push [MENU].
2. Select "RECORD."
3. Select "Voice Recorder."

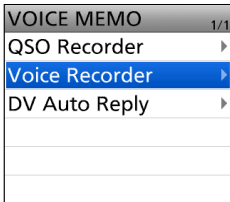

4. Select "Play Files."



5. Select the folder that contains the audio file to view the information.

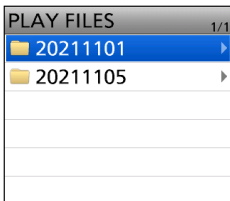

6. Select the audio file to view the information.

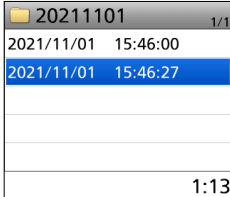

ⓘ **DO NOT** push [ENT].

7. Push [QUICK].
8. Select "File Information."

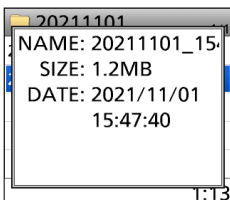
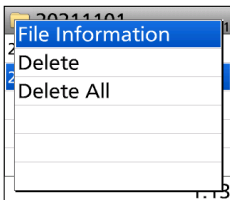

**TIP: To view the folder information**  
Push [QUICK] in step 5, and then select "Folder Information" to view the folder information.

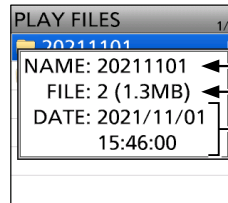
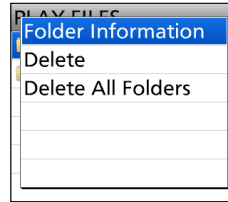

← Folder name  
← Total files (total size)  
← Created date and time

ⓘ To exit the MENU screen, push [MENU].

## Playing back the recorded audio on the PC

You can play back the recorded audio on your PC.

- ① Operation data is not displayed.
- ① Windows 10 is used for these instructions.

**Example:** Playing back the audio file on the microSD card on your PC.

1. Insert the microSD card into the memory card slot or memory card reader on your PC.

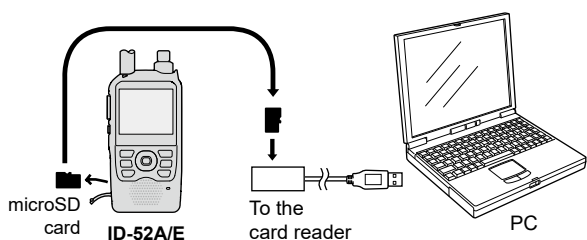

2. Click the “Open folder to view files” option to access the card.

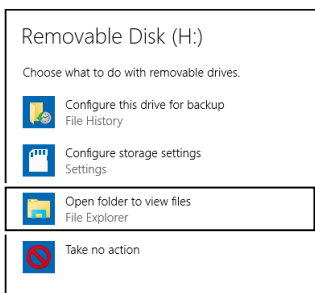

3. Double-click the 'ID-52' folder.

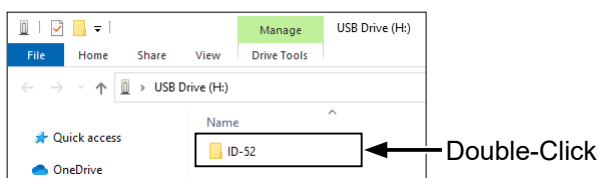

4. Double-click the 'Voice' folder.

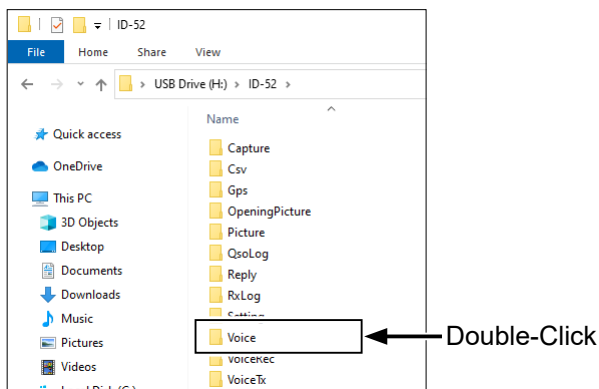

5. Double-click the folder that contains the audio file to play it back. (Example: “20211101”)

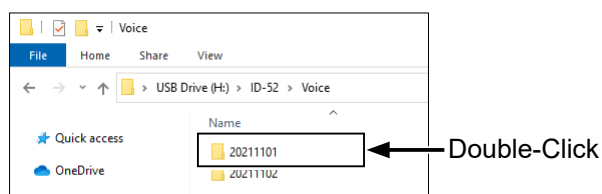

6. Double-click the file to play it back. (Example: “20211101\_152135A.wav”)

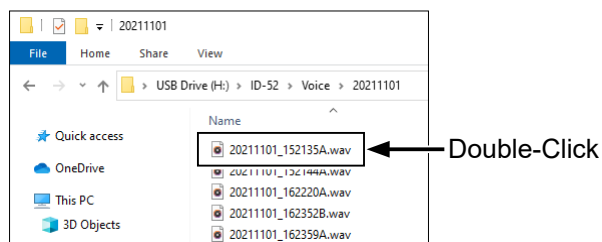

- ① See the instruction manual of your player for operation details.
- ① The audio file may not play back, depending on the player.

**TIP:** When “USB Connect” is set to “SD Card Mode,” and the transceiver is connected to the PC through a USB data cable, you can directly access the microSD card that is set in the transceiver from the PC. ([MENU] > SET > Function > **USB Connect**)

## RECORD items

### <<REC Start>>

[MENU] > RECORD > QSO Recorder > <<REC Start>>

After selecting “<<REC Start>>,” starts QSO recording.

- “Recording started.” is displayed.

#### ① Information

- **BE SURE** to insert a microSD card.
- While recording, “<<REC Stop>>” is displayed on the QSO RECORDER screen. To stop recording, select “<<REC Stop>>.”
- Once a recording has started, the recording will continue, even if the transceiver is turned OFF and then ON again.

### Play Files

[MENU] > RECORD > QSO Recorder > Play Files

Displays saved voice data folders.

- ① **BE SURE** to insert a microSD card.

#### Playing back:

1. Select a folder that contains the file you want to playback.
2. Select a file to playback.
  - The VOICE PLAYER screen is displayed and starts playing back the audio.
  - ① See page 8-3 for details.
3. Push [MENU] to exit the VOICE PLAYER screen.

#### NOTE:

- The folder is automatically named, as shown below:  
**(Example)**  
Recording date: 1st November 2021  
Folder name: 20211101
- The file is automatically named, as shown below:  
**(Example)**  
Recording date and time: 1st November 2021 15:30:00  
File name: 20211101\_153000
- The voice audio is recorded onto a microSD card, and saved in the “wav” format. (“.wav” is not displayed on the transceiver’s screen.)
- The recorded voice audio can also be played back on a PC.

### RX REC Condition

(Default: Squelch Auto)

[MENU] > RECORD > QSO Recorder > Recorder Set > RX REC Condition

Selects whether or not the squelch status affects the received voice audio recording.

- **Always:** The transceiver always records the receive voice audio regardless of the squelch status.
- **Squelch Auto:** The transceiver records the receive voice audio only when a signal is received (the squelch is opened). When the squelch closes while recording, the recording will continue for 2 seconds, and then pause.

### File Split

(Default: ON)

[MENU] > RECORD > QSO Recorder > Recorder Set > File Split

Turns the File Split function ON or OFF.

- **OFF:** Once a recording starts, the transceiver continues to record on the same file.
  - ① If the file size exceeds 2 GB, a new file is automatically created in the same folder, and the voice audio is recorded there.
- **ON:** During recording, if transmission and reception, or squelch status\* (open and close) is changed, a new file is automatically created in the same folder, and the voice audio is saved into a new file.  
\* Only when “RX REC Condition” is set to “Squelch Auto.”

### REC Operation

(Default: A/B Link)

[MENU] > RECORD > QSO Recorder > Recorder Set > REC Operation

Selects the recording operation on the dual band display.

- **A/B Separate:** The recording function is separately active/inactive on the selected band (MAIN band) when the function is started or stopped.
- **A/B Link:** The recording function is simultaneously active/inactive on both MAIN and SUB bands when the function is started or stopped.
  - ① On the single band display, only displayed band (A or B) is recorded.

## RECORD items

### PTT Auto REC (Default: ON)

[MENU] > RECORD > QSO Recorder > Recorder Set > **PTT Auto REC**

Turns the PTT Automatic Recording function ON or OFF.

① Transmitting from a speaker microphone or a Bluetooth headset, using the VOX function, or sending a CI-V command also starts recording.

- OFF: Turns OFF the function.
- ON: The recording automatically starts when you push [PTT].

#### The recording stops when:

- No signal is transmitted for 10 seconds after releasing [PTT].
- No signal is received for 10 seconds after releasing [PTT].
  - ① When the transceiver receives a signal within 10 seconds after releasing [PTT], the recording automatically starts.
- The operating frequency, Frequency Selecting mode, or operating mode is changed after releasing [PTT].

### Skip Time (Default: 10sec)

[MENU] > RECORD > QSO Recorder > Player Set > **Skip Time**

Sets the Skip Timer to 3, 5, 10, or 30 seconds to rewind or skip forward for this set period of time when you push the fast-rewind or fast-forward key while playing the recorded QSO audio.

① See "The VOICE PLAYER screen description" for forwarding or rewinding. (p. 8-3)

### Record

[MENU] > RECORD > Voice Recorder > **Record**

Push [ENT] to display the VOICE RECORDER screen, and then push [PTT] to start a voice recording. While recording, push [PTT] again to stop the recording. (p. 8-9)

#### ① Information

- **BE SURE** to insert a microSD card.
- This function cannot record a QSO.
- While recording a QSO, you cannot use this function.

### Play Files

[MENU] > RECORD > Voice Recorder > **Play Files**

Plays back the voice audio that is recorded on the VOICE RECORDER screen.

Push [ENT] to display the folders that contain the recorded voice audio files.

① **BE SURE** to insert a microSD card.

### MIC Gain (Default: 3)

[MENU] > RECORD > Voice Recorder > Recorder Set > **MIC Gain**

Sets the internal microphone sensitivity to between 1 (minimum sensitivity) and 4 (maximum sensitivity) for the Voice Recorder function. Higher values make the microphone more sensitive to your voice.

### Skip Time (Default: 10sec)

[MENU] > RECORD > Voice Recorder > Player Set > **Skip Time**

Sets the Skip Timer to 3, 5, 10, or 30 seconds to rewind or skip forward for this set period of time when you push the fast-rewind or fast-forward key while playing the recorded voice audio.

① See "The VOICE PLAYER screen description" for forwarding or rewinding. (p. 8-10)

### DV Auto Reply

[MENU] > RECORD > **DV Auto Reply**

Up to 10 seconds of audio can be recorded for the Automatic Reply function.

① **BE SURE** to insert a microSD card.

① See page 5-25 for details.

|  |      |
|--|------|
| General description .....  | 9-2  |
| ◇ Memory channel content .....   | 9-2  |
| Selecting a Memory channel .....   | 9-3  |
| Selecting a Call channel .....   | 9-3  |
| Entering Memory channel contents .....                                   | 9-4  |
| ◇ Entering into a selected channel .....                                 | 9-4  |
| ◇ Overwriting to the selected channel .....                              | 9-5  |
| ◇ Entering to a blank channel .....                                      | 9-5  |
| Copying Memory content to the VFO .....                                  | 9-6  |
| MEMORY screen .....  | 9-7  |
| ◇ Tree view of the MEMORY screen .....                                   | 9-7  |
| ◇ Viewing the Memory channel contents .....                              | 9-7  |
| Copying Memory contents to another Memory channel .....                  | 9-8  |
| Moving the Memory contents to another channel in a different group ..... | 9-9  |
| Inserting a blank channel .....  | 9-10 |
| Entering a group/memory name .....                                       | 9-11 |
| Selecting a memory name display .....                                    | 9-12 |
| Clearing a Memory contents .....   | 9-13 |

## General description

The Memory mode enables you to quickly select often-used frequencies, modes, and other parameters. While operating in the Memory mode, you can temporarily change the operating frequency, mode, and so on, without overwriting the memory channel contents.

| Group    | Memory channel         | Descriptions  |
|----------|------------------------|---|
| 00 to 99 | 00 to 99               | Regular memory channels. Up to 1000 channels can be separately stored in the 100 memory channel groups. |
| CALL CH  | 144 C0/C1<br>430 C0/C1 | Call channels each of the 144 and 430 bands.  |

**NOTE:** Memory content may be accidentally cleared by static electricity, electric transients, and other causes. In addition, it may be cleared by a malfunction, or during repairs. Therefore, we recommend that you backup the Memory content or save it onto a microSD card\* or a PC.

\*User supplied

① The CS-52 PROGRAMMING SOFTWARE can also be used to backup your memory content. See its instruction manual for details.

### ◇ Memory channel content

The following information can be entered into the Memory channels:

- Operating frequency
- Duplex ON/OFF
- Duplex direction (DUP+ or DUP-)
- Duplex frequency offset
- Memory name
- Scan skip setting
- Tuning step
- Operating mode
- Subaudible tone encoder, tone squelch, or DTCS squelch ON/OFF
- Subaudible tone frequency, tone squelch frequency, or DTCS code with polarity
- Digital code
- Digital Call sign squelch or Digital code squelch ON/OFF
- UR station call sign
- R1/R2 call signs

## Selecting a Memory channel

In the Memory mode, you can select the Memory channels by rotating [DIAL].

1. Push [MR] to enter the Memory mode.



- ① For only the ID-52A, pushing [MR] each time selects the Memory and Weather Channel modes.
2. Rotate [DIAL].
  - Selects a Memory channel.
  - ① Blank channels are not selected.
  - ① To select a Memory Group, push [QUICK], and then select "Group Select."
  - ① The Memory channels are commonly used for the A and B bands. On the B band, if you select a memory channel that is out of the selectable frequency range, "✖" is displayed, and the signal cannot be received.

### TIP: To sequentially select a channel in a different group

1. Push [QUICK].
2. Select "Channel Select Group Range."



3. Select "All Groups."

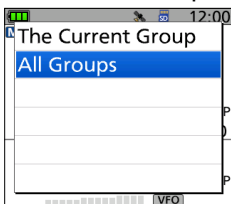

## Selecting a Call channel

Call channels are used for quick recall of most often used operating frequencies. Factory default frequencies and operating modes are entered into the Call channels. Change these to suit your operating needs.

1. Hold down [CALL] for 1 second to enter the Call Channel mode.



2. Rotate [DIAL].
  - Selects a Call channel.

## Entering Memory channel contents

After selecting a frequency in the VFO mode, you can enter it into a selected channel or an automatically selected blank channel.

### ◇ Entering into a selected channel

**Example:** Entering 146.030 MHz/FM mode into Channel 11 in Group 01.

1. Push [VFO/MHz] to enter the VFO mode.
2. Push [MODE] to enter the FM mode.
3. Rotate [DIAL] to set a frequency to 146.030 MHz.



4. Hold down [MW] for 1 second.
  - A short and a long beep sound.
5. Select "Write to New CH."

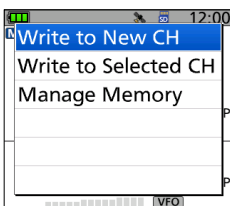

6. Push [QUICK].
7. Select "Group Select."

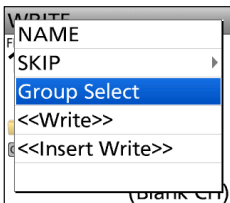

8. Select Group "01."

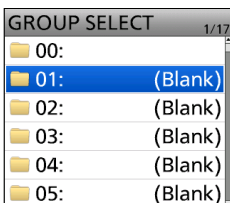

9. Rotate [DIAL] to select Channel "11."

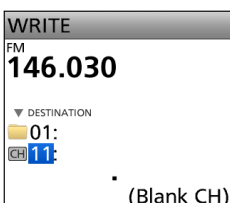

10. Push [ENT].
  - The confirmation dialog is displayed.
11. Select "YES."

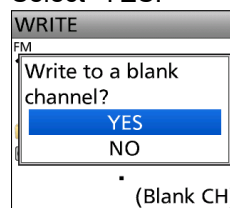

- Beeps sound and the Memory contents are briefly displayed, then returns to the VFO mode.

**TIP:** In step 7, you can select the following options.

- **NAME:**  
Displays the Memory name edit screen. (p. 9-11)
- **SKIP:**  
Displays the SKIP setting items.
- **Group Select:**  
Displays the GROUP SELECT screen.
- **<<Write>>:**  
Enters into the selected Memory channel.
- **<<Insert Write>>:**  
Inserts a Memory channel above the selected channel.

## Entering Memory channel contents

### ◇ Overwriting to the selected channel

You can write a frequency into a pre-entered channel.

**Example:** Entering 146.330 MHz/FM mode into Channel 11 in Group 01.

1. Push [MR] to enter the Memory mode.  
 Ⓜ For only the ID-52A, pushing [MR] each time selects the Memory and Weather Channel modes.
2. Rotate [DIAL] to select Channel 11 in Group 01.



Ⓜ To select a Memory Group, push [QUICK], and then select "Group Select."

3. Push [VFO/MHz] to enter the VFO mode.
4. Rotate [DIAL] to set a frequency to 146.330 MHz.



5. Hold down [MW] for 1 second.
  - A short and a long beep sound.
6. Select "Write to Selected CH."

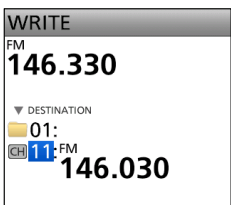
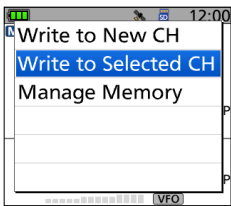

7. Push [MR].
8. Select "YES."

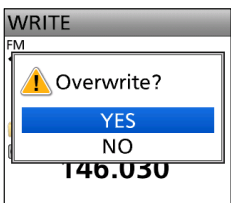

- Beeps sound and the Memory contents are briefly displayed, then returns to the VFO mode.

### ◇ Entering to a blank channel

**Example:** Entering 441.100 MHz/FM mode into a blank channel.

1. Push [VFO/MHz] to enter the VFO mode.
2. Push [MODE] to enter the FM mode.
3. Rotate [DIAL] to set a frequency to 441.100 MHz.

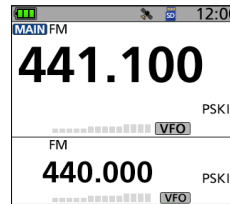

4. Hold down [MW] for 3 seconds.

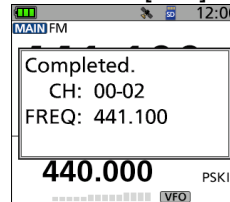

- The Memory contents are briefly displayed for 2 seconds, then returns to the VFO mode.

## Copying Memory content to the VFO

It is convenient when you want to operate on a channel frequency near a Memory or Call channel.

**Example:** Copying Memory Channel 11 in Group 01 to the VFO.

1. Push [MR] to enter the Memory mode.
  - ① For only the ID-52A, pushing [MR] each time selects the Memory and Weather Channel modes.
2. Rotate [DIAL] to select Channel 11 in Group 01.



① To select a Memory Group, push [QUICK], and then select "Group Select."

3. Hold down [MW] for 1 second.
  - A short and a long beep sound.
4. Select "Copy to VFO."

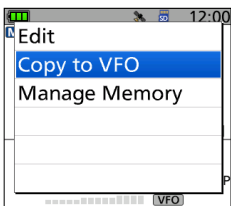

5. Select "YES."

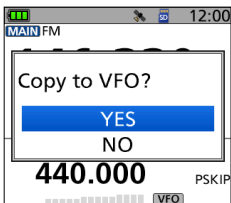

- Beeps sound and copies the selected Memory contents to the VFO, then returns to the VFO mode.

## MEMORY screen

On the MEMORY screen, you can easily manage the Memory or Call channel content.

### Tree view of the MEMORY screen

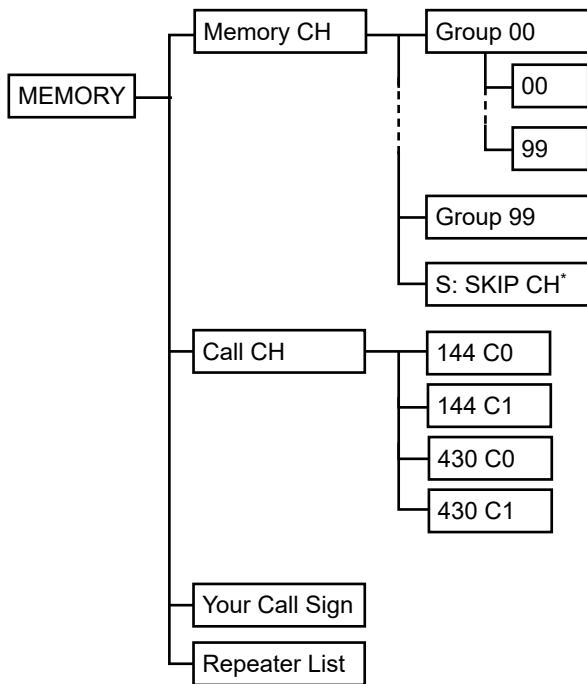

\* Skips the set frequency during a scan.  
(While a VFO scan is paused and if you want to skip the frequency, holding down [MW] for 1 second sets the frequency as the Skip channel.)

### Viewing the Memory channel contents

You can view the Memory channel contents on the MEMORY screen.

**Example:** Viewing the contents of Channel 01 in Group 00.

[MENU] > MEMORY > **Memory CH**

1. Push [MENU].
2. Select "MEMORY" on the second page of the MENU screen.
  - ① In the VFO, Memory, or Call Channel mode, you can open the MEMORY screen by holding down [MW] for 1 second, then selecting "Manage Memory."
3. Select "Memory CH."
4. Select Group "00."

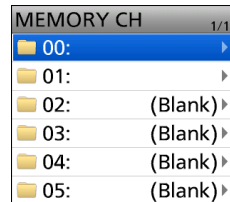

5. Select Channel "01."

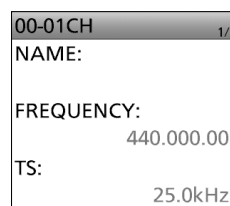
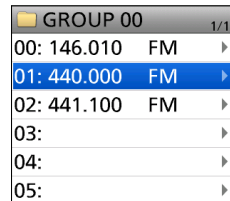

- Channel contents are displayed.
- ① Rotate [DIAL] to scroll the screen.
- ① To exit the MENU screen, push [MENU].

**TIP:** To edit, copy, or clear the memory content.

1. Push [QUICK] in step 5.
2. Select "Edit," "Copy," or "Clear."

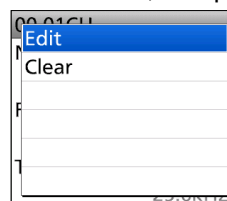

## Copying Memory contents to another Memory channel

You can copy the memory content to another Memory channel.

**Example:** Copying Channel 01 in Group 00 to Channel 06 in Group 00.

[MENU] > MEMORY > **Memory CH**

1. Push [MENU].
2. Select "MEMORY."
3. Select "Memory CH."
4. Select Group "00."
5. Select Channel "01."

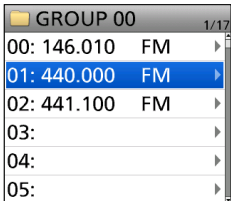

ⓘ **DO NOT** push [ENT].

6. Push [QUICK].
7. Select "Copy."

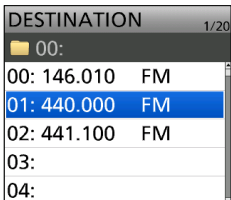
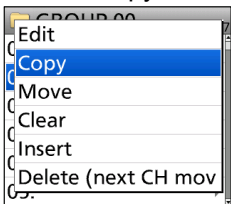

8. Select the destination channel.

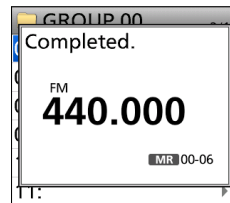
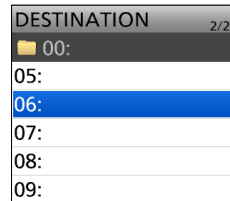

- Beeps sound, and the contents are copied to the destination channel.
- ⓘ If the selected channel is not blank, a confirmation dialog is displayed. When you select "YES," the Memory contents are overwritten.

**TIP: To copy the channel to a different group**  
In step 6, while "DESTINATION" is displayed, push [QUICK] and select "Group Select."

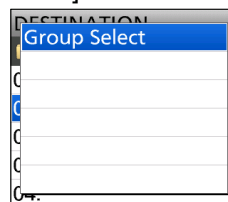

- The GROUP SELECT screen is displayed.

## Moving the Memory contents to another channel in a different group

You can move the memory content to another Memory channel in a different group.

**Example:** Moving Channel 01 in Group 00 to Channel 00 in Group 02.

[MENU] > MEMORY > **Memory CH**

1. Push [MENU].
2. Select "MEMORY."
3. Select "Memory CH."
4. Select Group "00."
5. Select Channel "01."

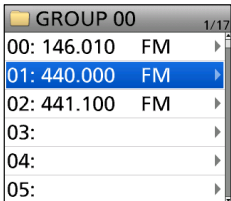

ⓘ **DO NOT** push [ENT].

6. Push [QUICK].
7. Select "Move."

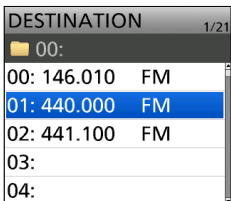
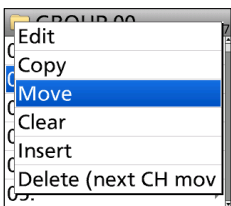

8. Push [QUICK].
9. Select "Group Select."

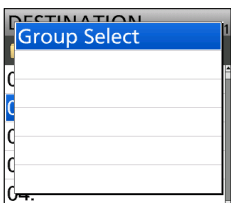

10. Select the destination group.

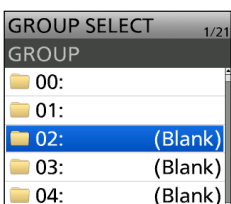

11. Select the destination channel.

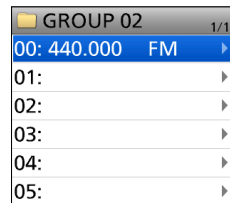
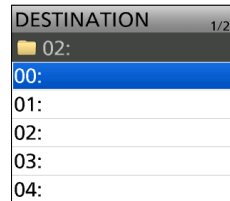

- Beeps sound, and the contents are moved to the destination channel.

ⓘ Channels other than the one that you moved will move up.

**TIP: To rearrange the display order in the selected group**  
In step 7, while "DESTINATION" is displayed, go to step 11.

## Inserting a blank channel

You can insert a blank channel between 2 Memory channels. This function is convenient to organize your memory channels.

**Example:** Inserting a blank channel between Channel 00 and 01 in Group 00.

[MENU] > MEMORY > **Memory CH**

1. Push [MENU].
2. Select "MEMORY."
3. Select "Memory CH."
4. Select Group "00."
5. Select Channel "01."

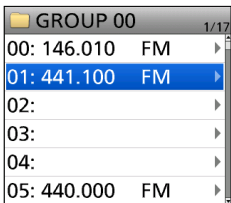

ⓘ **DO NOT** push [ENT].

6. Push [QUICK].
7. Select "Insert."

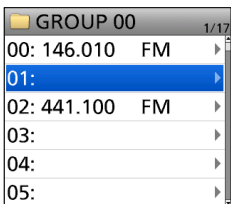
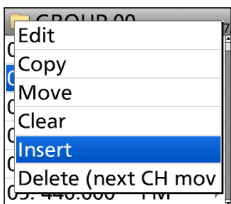

- Beeps sound, a blank channel is inserted above the selected channel.

ⓘ If you select channel 99 in step 5, a confirmation dialog is displayed. When you select "YES," channel 99 is deleted.

### TIP: To insert a blank group

On the Memory Group screen, select a group and push [QUICK], then select "Insert Group."

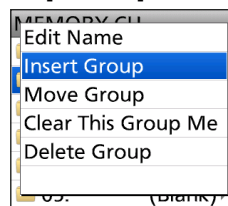

- A blank group is inserted above the selected group.

## Entering a group/memory name

You can assign a name of up to 16 characters to each channel group (00 ~ 99) and memory channel.

**Example:** Entering “Calling” as a Memory name to Channel 01 in Group 00.

[MENU] > MEMORY > **Memory CH**

1. Push [MENU].
2. Select “MEMORY.”
3. Select “Memory CH.”
4. Select Group “00.”
5. Select Channel “01.”

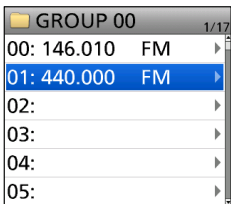

ⓘ **DO NOT** push [ENT].

6. Push [QUICK].
7. Select “Edit.”

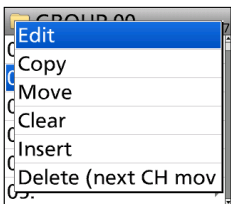

8. Select “NAME.”

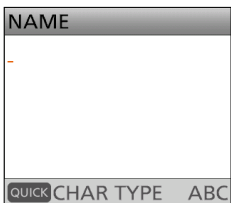
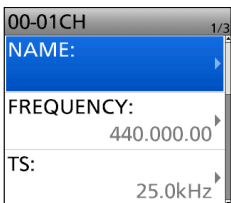

9. Enter a name.

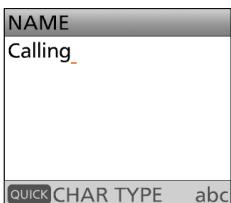

ⓘ See page iii on how to enter characters.

10. After entering, push [ENT].

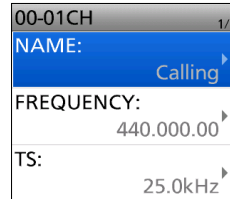

11. Select “<<Overwrite>>.”

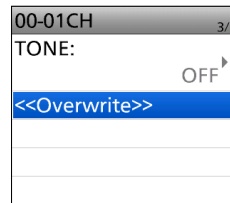

12. Select “YES.”

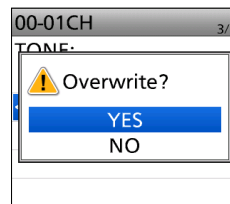

- Beeps sound, then returns to the Memory channel screen.

### TIP: To enter a group name

On the Memory Group list screen, select a group and push [QUICK], then select “Edit Name.”

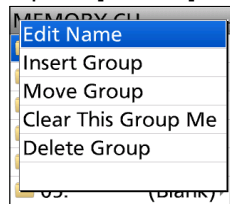

- The Group Name edit screen is displayed.

## Selecting a memory name display

While in the memory mode, the entered memory name can be displayed in different styles. You can select a display type.

**Example:** Selecting “Name (Large)” in the Single band display.

1. Push [MR] to select the Memory mode.
  - ① For only the ID-52A, pushing [MR] each time selects the Memory and Weather Channel modes.
2. Push [QUICK].
3. Select “Display Type.”

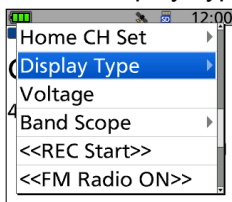

4. Select a display type.

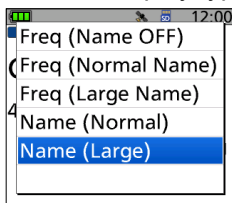

① “Freq (Name OFF)” is set as the default.

**TIP:** There are 5 types of Memory name displays.

- **Freq (Name OFF):**  
Displays only the frequency.

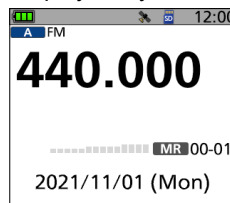

- **Freq (Normal Name):**  
Displays the large font sized frequency and small font sized Memory name.  
① In the Dual band display, select “Freq.”



- **Freq (Large Name):**  
Displays the large font sized frequency and large font sized Memory name.  
① You cannot select in the Dual band display.



- **Name (Normal):**  
Displays the small font sized Memory name and small font sized frequency.



- **Name (Large):**  
Displays the large font sized Memory name and small font sized frequency.



## Clearing a Memory contents

Contents of entered memories can be cleared (erased), if desired.

- ① The cleared channel becomes a blank channel.
- ① You can also clear the Skip channels (Group “S”).

**NOTE:** Cleared memory channel contents cannot be restored.

**Example:** Clearing channel 01 in group 00.

[MENU] > MEMORY > **Memory CH**

1. Push [MENU].
2. Select “MEMORY.”
3. Select “Memory CH.”
4. Select Group “00.”
5. Select Channel “01.”

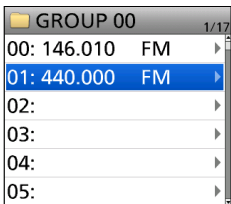

① **DO NOT** push [ENT].

6. Push [QUICK].
7. Select “Clear.”

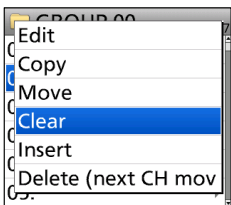

8. Select “YES.”

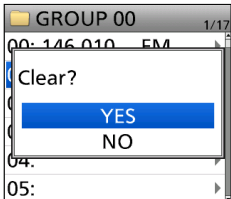

- Beeps sound, and the contents are cleared.

**TIP: To Delete a memory channel**

In step 7, select “Delete (next CH moves up).”

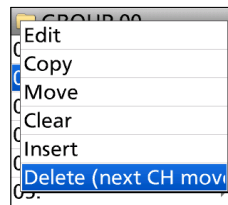

- The selected channel is deleted.
- ① You can also delete Memory groups. Select a group, then select “Delete Group.”

# Section 10 SCAN OPERATION

---

|   |       |
|---|-------|
| Scan Type.....                            | 10-2  |
| ◇ VFO scan .....                          | 10-2  |
| ◇ Memory scan.....                        | 10-2  |
| About Scans .....                         | 10-4  |
| ◇ [DIAL] operation during a scan.....     | 10-4  |
| ◇ Squelch setting for a scan.....         | 10-4  |
| ◇ Tuning step for a VFO scan.....         | 10-4  |
| ◇ Scan Skip function.....                 | 10-4  |
| ◇ Operating mode during a scan .....      | 10-4  |
| ◇ When a signal is received .....         | 10-4  |
| ◇ Scan Stop Beep function.....            | 10-4  |
| VFO Scan .....                            | 10-5  |
| ◇ Scan Type.....                          | 10-5  |
| ◇ About a Program scan name.....          | 10-6  |
| ◇ About a Program Link scan name .....    | 10-6  |
| ◇ Storing the skip frequencies .....      | 10-6  |
| ◇ Entering Program Scan Edges .....       | 10-7  |
| ◇ About the Program Link Scan .....       | 10-8  |
| ◇ Setting the Program Link function ..... | 10-8  |
| Memory Scan .....                         | 10-9  |
| ◇ Scan Type.....                          | 10-9  |
| ◇ About a Group scan name .....           | 10-10 |
| ◇ Setting the Group Link.....             | 10-10 |
| ◇ Setting the skip channel .....          | 10-11 |
| Temporary skip function.....              | 10-11 |

# 10 SCAN OPERATION

## Scan Type

Scanning is a versatile function that can automatically search for signals. A scan makes it easier to locate stations to contact or listen to, or to skip unwanted channels or frequencies.

### ◇ VFO scan

The VFO scan searches for signals within the specified frequency range.

#### Full scan (ALL)

Repeatedly scans the entire band.

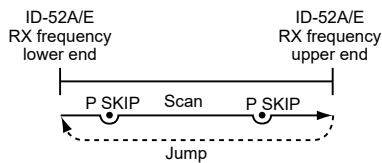

#### Band scan (BAND)

Repeatedly scans the selected band.

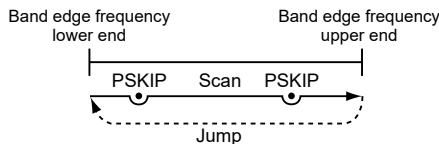

#### Program scan (P00 ~ P24)

Repeatedly scans the selected Program Scan range (P-Scan Edge 00 ~ 24).

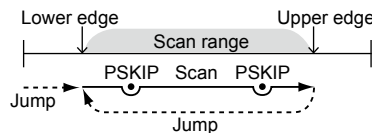

- ① At least one Program Scan range (P-Scan Edges) must be entered to start a Program scan.  
 ([MENU] > SET > Scan > **P-Scan Edge**)  
 See page 10-7 for more details.

#### Program Link scan (P-LINK 0 ~ 9)

Sequentially scans the Program Scan ranges. The links are set on the MENU screen.

([MENU] > SET > Scan > **Program Link**)

- ① See page 10-8 for more details.

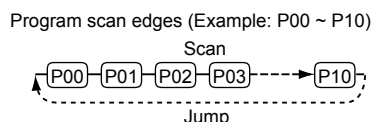

### ◇ Memory scan

The Memory scan searches signals on the preregistered memory channels.

#### ALL scan (ALL)

Repeatedly scans all memory channels.

Memory Groups (00 ~ 99 and S: Skip CH)

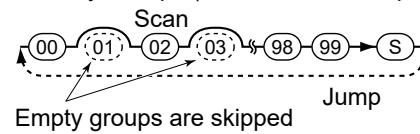

#### Selected band scan (BAND)

Scans all memory channels on the same frequency band as the selected channel.

#### Mode scan (MODE)

Scans memory channels that are entered with the same operating mode as the currently selected mode.

- ① The Mode scan scans all memory groups.  
 (Group 00 ~ 99, S: SKIP CH)

Example: Scanning AM mode  
 Memory group 02

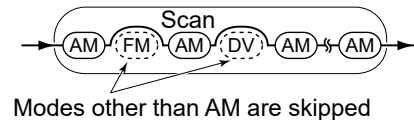

#### Group link scan (GROUP LINK)

Sequentially scans the memory groups that are set to link on the MENU screen.

Memory Groups (00 ~ 99 and S: Skip CH)

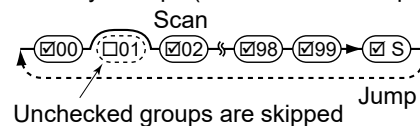

- ① At least 2 groups must be checked to start a Group Link scan. ([MENU] > SET > Scan > **Group Link**)  
 See page 10-10 for more details.

#### Group scan (GROUP 00 ~ 99)

Scans the Memory channels in the selected group.

---

# 10 SCAN OPERATION

## Scan Type

### **Duplex (DUP) scan**

The Duplex scan searches for signals on both TX and RX frequencies used in duplex operation (p. 11-4).

- ① “D-” or “D+” is displayed in the Duplex mode.
- ① A Duplex scan does not start when the frequency offset is set to “0.000.00 MHz.”

### **Tone scan**

The Tone scan searches for signals with tone frequencies or DTCS codes from stations using the Tone Squelch function.

- ① A Tone scan is usable in any VFO, Memory, or Call channel mode.
- ① During a scan, rotate [DIAL] to change the scan direction.
- ① See pages 15-8 and 15-9 about the Tone Squelch function and DTCS Code Squelch function.

## About Scans

### ◇ [DIAL] operation during a scan

- Rotate [DIAL] to change the scan direction during a scan.
- When the scan is paused, rotate [DIAL] to resume the scan.

### ◇ Squelch setting for a scan

You can change the squelch level to suit your operating needs. Set the squelch level to open the squelch, according to the received signal strength.

- ① During a scan, rotate [DIAL] while holding down [SQL] to adjust the squelch level. The scan resumes after adjusting.

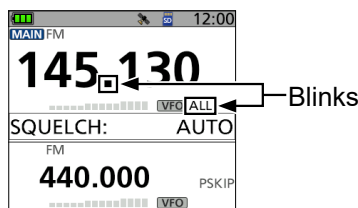

### ◇ Tuning step for a VFO scan

The selected tuning step is applied to the scan. For a Program scan or Program Link scan, set the tuning step in the Program Scan Edge ranges (P-Scan Edge).

### ◇ Scan Skip function

The skip function speeds up scanning by not scanning those frequencies set as skip channels.

- ① These settings can be separately set to A band and B band.

#### In the VFO mode

The frequencies that are set as "PSKIP" are skipped during a scan. (p. 10-6)

#### In the Memory mode

The frequencies that are set as skip channels "PSKIP" and "SKIP" are not scanned. (p. 10-11)

- ① You must enter 2 or more Memory channels to start a memory scan.

**TIP:** When "Program Skip" is set to OFF, you cannot use the Program Skip scan function. (p. 12-5)  
 ([MENU] > SET > Scan > **Program Skip**)

### ◇ Operating mode during a scan

- The VFO scan uses the selected operating mode.
- During a Memory mode scan, the operating mode entered into the channel is used.

### ◇ When a signal is received

When a signal is received, the scan pauses for this set period of time. (p. 12-5)

When a received signal disappears, the scan resumes for this set period of time. (p. 12-5)

- ① These settings can be separately set to A band and B band.

[MENU] > SET > Scan > **Pause Timer**

[MENU] > SET > Scan > **Resume Timer**

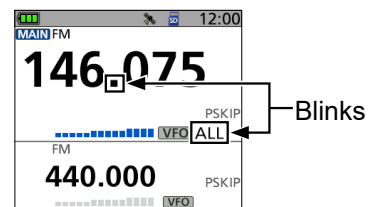

### ◇ Scan Stop Beep function

The Scan Stop Beep function sounds a beep when a signal is received.

This function can be turned ON or OFF on the MENU screen. (p. 12-29)

[MENU] > SET > Sounds > **Scan Stop Beep**

## VFO Scan

1. Push [VFO/MHz] to enter the VFO mode.
2. Push [MODE] to select the operating mode.
3. Hold down [SCAN] for 1 second.
  - Opens the Scan Type Select window.
4. Select a scan type.



- The scan starts.
  - The decimal point and the selected Scan Type icon blink.
- ① When receiving a signal, the S-meter displays the received signal strength.
5. Hold down [SCAN] for 1 second.
    - Cancels the scan.
- ① Pushing [CLR] also cancels the scan.

### ◇ Scan Type

- ALL: Full scan
- BAND: Band scan
- DUP: Duplex scan  
(Displayed only when Duplex is set)
- P-LINK0 ~ 9: Program Link scan
- P00 ~ 24: Program scan
- TONE: Tone scan  
(For the Tone Squelch scanning)

### ① Information

- The frequencies that are set as a Skip channel (PSKIP) are skipped during a scan. (p. 10-6)
- When "Program Skip" is set to "OFF," the Skip channel frequencies are not skipped. (p. 12-5)  
([MENU] > SET > Scan > **Program Skip**)
- To set a Program Link scan, see page 10-8.
- To set a Program scan, see page 10-7.

### TIP:

- During a scan, rotate [DIAL] to change the scanning direction.
- During a scan, push [MODE] to select the operating mode.
- During a scan, hold down [LOCK] to turn the Lock function ON or OFF.
- The scan continuously runs, even if you push [MENU] or [QUICK] during a scan.
- You can select a scan type by rotating [DIAL] while holding down [SCAN]. Release [SCAN] to start the scan.

## VFO Scan

### ◇ About a Program scan name

When a Scan name is entered to a Program scan, the name is displayed in the Scan Type Select window. (p. 10-5)

- ① The name is not displayed during a scan.
- ② To enter the name, see page 10-7.

#### When the Scan name is entered



#### When the Scan name is not entered



### ◇ About a Program Link scan name

When a Program Link scan name is entered, it is displayed in the Scan Type Select window. (p. 10-5)

- ① The name is not displayed during a scan.
- ② To enter the name, see page 10-8.

#### When a Program Link name is entered



#### When a Program Link name is not entered



### ◇ Storing the skip frequencies

You can skip unnecessary frequencies during a scan. While a scan is paused and if you want to skip the frequency, you can store it into the Skip channels group S (00 ~ 99) as a Skip channel (PSKIP). The Scan Skip function speeds up a scan.

1. While a VFO scan is paused, hold down [MW] for 1 second.



2. Select "Adds to SKIP MR Group."
  - The window, as shown above, is displayed.
2. Select "Adds to SKIP MR Group."
  - Two short beeps sound.
  - The frequency is stored in the Skip channels group.
  - After storing, the scan resumes.
  - ① If there is no blank channel, an error beep sounds, and the frequency is not stored.

**TIP:** Once a frequency is set as a Skip channel, the frequency is skipped until you clear the skip setting. To clear the skip setting, see page 10-11.  
 ① The skip setting is also cleared when the Memory channel set as a Skip channel is cleared.

# 10 SCAN OPERATION

## VFO Scan

### ◇ Entering Program Scan Edges

You can enter the upper and lower frequency edges for a Program scan.

Each Program Scan range has its tuning step and operating mode setting.

You can enter up to 25 Program Scan ranges (P-Scan Edge) on the MENU screen.

#### [MENU] > SET > Scan > P-Scan Edge

1. Push [MENU].
2. Select "Scan" in the "SET" menu.
3. Select "P-Scan Edge."

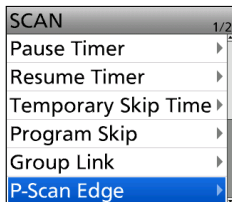

4. Select a blank Program scan range "00" ~"24."

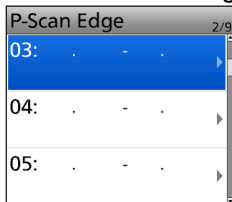

① **DO NOT** push [ENT].

5. Push [QUICK].
6. Select "Edit."

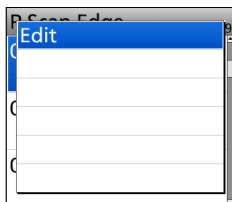

• The edit screen is displayed.

7. Select "FREQ LOW" or "FREQ HIGH" to enter the lower edge and higher edge, and then push [ENT].

#### ① Information

- Rotate [DIAL] to select the item, and push [ENT] to enter the edit screen.
- Set the lower edge and higher edge by rotating [DIAL].  
Push [VFO/MHz] to select the 1 MHz tuning step.
- When the "NAME" is entered, it displays on the Scan Type Select window.  
See page iii on how to enter characters.
- When the "TS" (Tuning Step) and/or "MODE" is blanked, they have used the current setting on the VFO mode.  
The "TS" and "MODE" must be set to match with your desired signals.

8. After editing contents, select "<<Write>>."
  - The confirmation dialog is displayed.
9. Select "Yes."

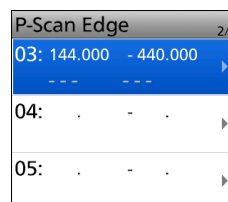
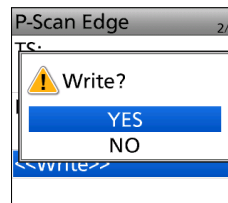

① To exit the MENU screen, push [MENU].

#### TIP:

- To clear the Program scan range, select "Clear" in step 6.
- When scanning a range where the set "TS" or "MODE" cannot be used, the preset "TS" or "MODE" setting on each band is applied.

### ◇ About the Program Link Scan

This item sets the Link function for 2 or more Program Scan ranges to sequentially scan during a Program Link scan. The Program Link scan scans all frequencies in the scan ranges.

#### Example settings of the Program Link

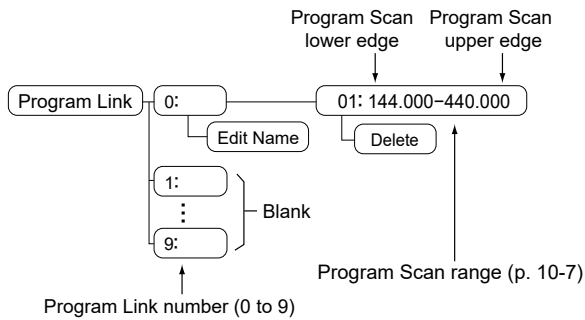

#### ① Information

- The Program Link Number screen displays the frequency range.
- You can add a Link setting by pushing [QUICK] when 2 or more Program Scan ranges (P-Scan Edge) are entered.
- When there is no Program Scan range (P00 ~ P24) entered, "Add" is not displayed after pushing [QUICK].

### ◇ Setting the Program Link function

[MENU] > SET > Scan > Program Link

1. Push [MENU].
2. Select "Scan" in the "SET" menu.
3. Select "Program Link."

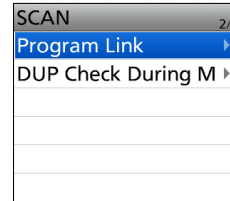

4. Select a Program Link number "0" ~ "9."

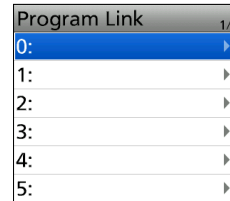

- The Program Link Number screen displays the preregistered Program Scan ranges.
- ① When no Program Scan range is selected, "– Blank –" is displayed.

5. Push [QUICK].
6. Select "Add."

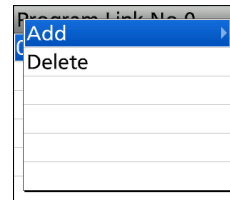

7. Select the Program Scan range that you want to add.

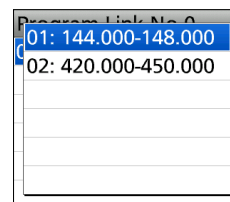

8. Repeat steps 6 and 7 until all Program scan ranges that you want are added.
9. Push [ENT] to save the Program Link.
- ① To exit the MENU screen, push [MENU].

#### TIP:

- To edit the name of the Program Link, push [QUICK] and select "Edit Name" at above step 4.
- To delete the registered Program Scan range from the Program Link, select "Delete" at above step 6.

## Memory Scan

**NOTE:** You must enter 2 or more Memory channels that are not set as Skip channels to start a Memory scan.

1. Push [MR] to enter the Memory mode.
  - ① For only the ID-52A, pushing [MR] each time selects the Memory and Weather Channel modes.
2. Hold down [SCAN] for 1 second.
  - Opens the Scan Type Select window.
3. Select a scan type.

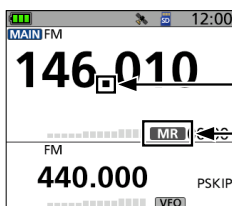
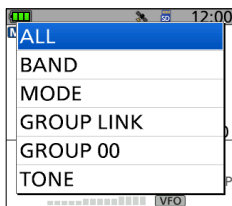

Blinks

- The scan starts.
  - The decimal point and "MR" blink.
  - ① When receiving a signal, the S-meter displays the received signal strength.
4. Hold down [SCAN] for 1 second.
    - Cancels the scan.
    - ① Pushing [CLR] also cancels the scan.

### ◇ Scan Type

- ALL: Full scan
- BAND: Band scan
- MODE: MODE scan
- DUP: Duplex scan  
(Displayed only when Duplex is set)
- GROUP LINK: Group Link scan
- GROUP 00 ~ 99: Group scan
- TONE: Tone scan  
(For the Tone Squelch scanning)

- ① When 2 or more Memory channels that are not set as Skip channels are entered, the Memory scan is usable.
- ① The channel set as a Skip channel (PSKIP or SKIP) is skipped during a scan. (p. 10-11)

#### TIP:

- During a scan, rotate [DIAL] to change the scanning direction.
- During a scan, hold down [LOCK] to turn the Lock function ON or OFF.
- The scan continuously runs, even if you push [MENU] or [QUICK] during a scan.
- You can select a scan type by rotating [DIAL] while holding down [SCAN]. Release [SCAN] to start the scan.

## Memory Scan

### ◇ About a Group scan name

When a group name is entered to a Memory channel group, the name is displayed in the Scan Type Select window. (p. 10-9)

- ① The name is not displayed during a scan.
- ② To enter the name, see page 9-11.

#### When the Group name is entered

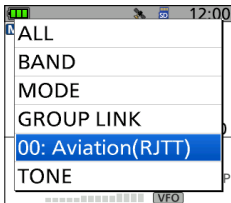

#### When the Group name is not entered

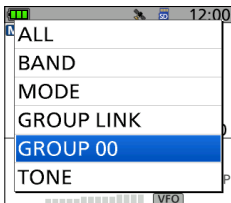

### ◇ Setting the Group Link

You can sequentially scan the memory groups which are set to link on the MENU screen.

- ① In the default setting, all groups are set to link.

#### [MENU] > SET > Scan > Group Link

1. Push [MENU].
2. Select "Scan" in the "SET" menu.
3. Select "Group Link."

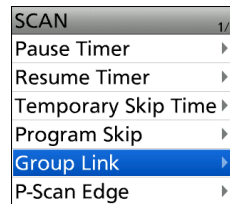

4. Select a group, "00" ~ "99," "S: SKIP CH."

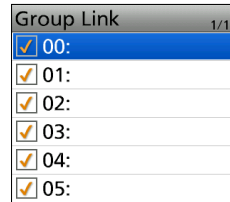

5. Push [ENT] to turn the Link function ON or OFF.
  - "✓" is displayed when the function is set to "ON."
- ① Push [QUICK] to quickly turn all the groups ON or OFF.

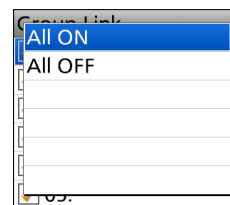

- ① To exit the MENU screen, push [MENU].

# 10 SCAN OPERATION

## Memory Scan

### ◇ Setting the skip channel

You can set or clear a Skip Channel setting. The channels that are set as a Skip channel are skipped during a scan.

1. Push [MR] to enter the Memory mode.  
① For only the ID-52A, pushing [MR] each time selects the Memory and Weather Channel modes.
2. Select the memory channel to be skipped.
3. Push [QUICK].
4. Select "SKIP."
5. Select an option.

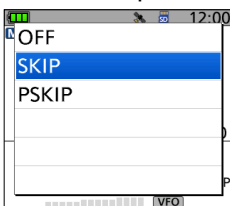

← When a Skip channel is set, "SKIP" or "PSKIP" is displayed.

- OFF: Cancels the Skip Channel setting.
- SKIP: Skipped during a Memory scan.
- PSKIP: Skipped during both VFO and Memory scans.

## Temporary skip function

This function temporarily skips unwanted frequencies (or memory channels) during a scan for the set period of time or condition, without changing the Skip Channel setting.

1. While a scan is paused, hold down [MW] for 1 second.
2. Select "Temp Skip Set."

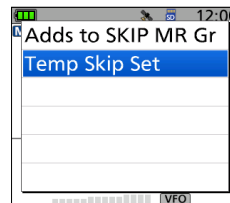

- Sets the frequency or Memory channel as a Skip Frequency or Channel.
- The scan automatically resumes.

### TIP:

- Up to 20 Temporary Skip frequencies or Memory channels can be set. When the 21st frequency or Memory channel is set, the oldest setting is automatically deleted.
- You can also set the Temporary Skip function in the Quick Menu window.
- The Temporary Skip function is canceled when the Temporary Skip Timer (Default: 5 min) has passed, or when selecting "Temp Skip Cancel" in the Quick Menu window.  
([MENU] > SET > Scan > **Temporary Skip Timer**)

# Section 11 REPEATER AND DUPLEX OPERATIONS

---

|  |      |
|--|------|
| FM Repeater operation.....                 | 11-2 |
| ◇ Setting the Repeater frequency.....      | 11-2 |
| ◇ Checking the Repeater input signal ..... | 11-3 |
| ◇ 1750 Hz tone burst .....                 | 11-3 |
| Duplex operation .....                     | 11-4 |
| ◇ Setting the frequency offset.....        | 11-4 |
| ◇ Setting the duplex direction .....       | 11-4 |
| ◇ Duplex operation .....                   | 11-4 |
| Auto Repeater function.....                | 11-5 |
| Off band indication.....                   | 11-5 |

## FM Repeater operation

A Repeater receives signals and on one frequency, and then retransmits them on a different frequency. When using a Repeater, the transmit frequency is shifted from the receive frequency by a frequency offset.

A Repeater can be accessed using the Duplex function by setting the transceiver's offset to the same value as the Repeater's offset.

See Section 5 for details on accessing a D-STAR Repeater.

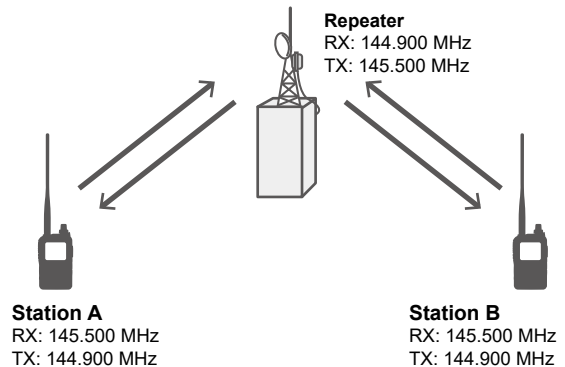

### ◇ Setting the Repeater frequency

1. Push [VFO/MHz] to enter the VFO mode.
2. Push [MODE] to select the FM mode.



3. Rotate [DIAL] to set the frequency received from a repeater.



#### TIP: For only the USA version

The Auto Repeater function (p. 11-5) automatically sets the repeater settings (duplex ON/OFF, duplex direction, tone encoder ON/OFF). When the function is ON, steps 4 ~ 8 are not necessary.

① You can turn OFF the function and manually set the repeater settings.  
([MENU] > SET > Function > **Auto Repeater**)

4. Set the offset frequency and the Duplex direction. (p. 11-4)



- The Duplex icon is displayed.

5. Set the Repeater tone. (Default: 88.5 Hz) ([MENU] > SET > DUP/TONE... > **Repeater Tone**) (p. 12-4)
6. Push [MENU] to exit the MENU screen.

7. Push [QUICK].
8. Select "TONE" and turn ON the Repeater Tone.



- The TONE icon is displayed.
9. Hold down [PTT] for 2 seconds.
    - If your transmit signal reached the repeater, after releasing [PTT], you can hear the repeater's call sign in morse codes or its announcement.

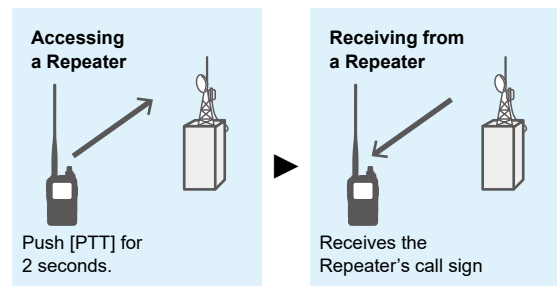

10. Operate in the same way as a simplex call, alternately transmit and receive.

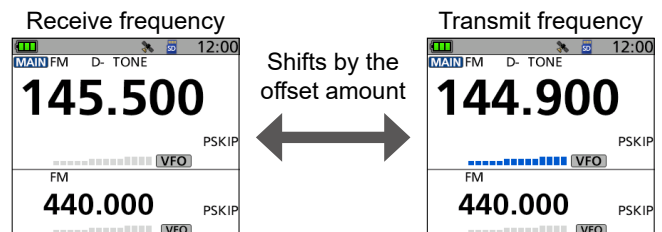

#### TIP:

- When the repeater tone frequency or the frequency offset is changed, the tone or offset for Auto Repeater function is also changed.
- If the offset value causes the transmit frequency to be out of the band, "OFF BAND" is displayed on the display when you push [PTT], and transmit is inhibited. (p. 11-5)

# 11 REPEATER AND DUPLEX OPERATIONS

## FM Repeater operation

### ◇ Checking the Repeater input signal

You can check whether or not that another station's transmit signal can be received directly (not through a repeater), by listening to the repeater input frequency.

Hold down [SQL] to listen on the repeater input frequency.

Display while monitoring



### ① Information

- While monitoring, the status indicator lights green, and an S/Rf meter dot blinks.
- While monitoring, the displayed frequency automatically changes to the transceiver transmit frequency (repeater input frequency).
- When the other station's signal can be directly received, move to a non-repeater frequency, and use simplex. (Duplex OFF)

### ◇ 1750 Hz tone burst

A 1750 Hz tone is required to access many European repeaters.

#### For the ID-52E only

Push [PTT] briefly and release, and then hold down [PTT] to transmit a 1750 Hz tone burst signal.

1. Push [MENU].
2. Select "DTMF/T-CALL" in the "SET" menu.

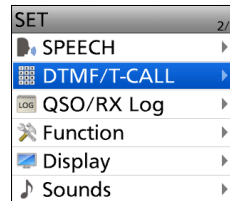

3. Select "DTMF Memory."

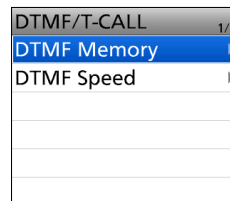

4. Select "T-CALL."

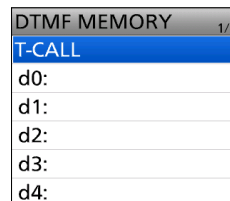

5. Push [MENU] to exit the MENU screen.
6. Rotate [DIAL] to set the frequency received from a repeater.
7. Set the offset frequency and the duplex direction. (p. 11-4)
  - The duplex icon is displayed.
8. While holding down [PTT] to transmit, push [SQL] to transmit a 1750 Hz tone signal.
  - Accesses the repeater with a short tone burst.
9. Operate in a normal way.
  - ① In the same way as a simplex call, alternately transmit and receive.

## Duplex operation

The duplex operation shifts the transmit frequency up or down from the receive frequency by an offset amount.

### ◇ Setting the frequency offset

**NOTE:** The frequency offset cannot be changed when using the DR function.

[MENU] > SET > DUP/TONE... > **Offset Freq**

1. Push [MENU].
2. Select “DUP/TONE...” in the “SET” menu.

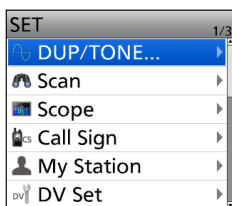

3. Select “Offset Freq.”

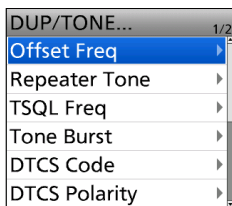

4. Rotate [DIAL] to set the offset.



#### ① Information

- Set to between 0.000.00 and 59.99500 MHz.
- The selected tuning step in the VFO mode is used to set the offset.
- To exit the MENU screen, push [MENU].

**TIP:** If the offset value causes the transmit frequency to be out of the band, “OFF BAND” is displayed when you push [PTT], and transmit will be inhibited. (p. 11-5)

### ◇ Setting the duplex direction

1. Push [QUICK].
2. Select “DUP.”

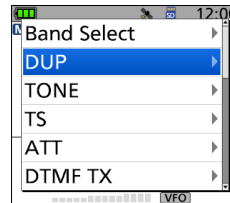

3. Select the duplex direction.
  - **OFF:** For simplex operation (the receive and transmit frequencies are the same).
  - **DUP-:** The transmit frequency shifts down from the receive frequency by the offset amount.
  - **DUP+:** The transmit frequency shifts up from the receive frequency by the offset amount.

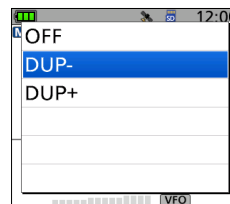

- Displays “D-” or “D+.”

### ◇ Duplex operation

1. Hold down [SQL] to listen to the transmit frequency to check whether another station is transmitting on it, or not.
  - The shifted transmit frequency is displayed.
2. Operate in a normal way.
  - ① In the same way as a simplex call, alternately transmit and receive.

**NOTE:** When the Auto Repeater function is ON, and the operating frequency is set out of the repeater output frequency range, the Duplex mode is automatically canceled. ([MENU] > SET > Function > **Auto Repeater**)

# 11 REPEATER AND DUPLEX OPERATIONS

## Auto Repeater function

When the operating frequency falls within the Repeater output frequency range, the Auto Repeater function automatically sets the Repeater settings (Duplex ON/OFF, Duplex direction, Tone encoder ON/OFF). The Auto Repeater function uses the preset repeater tone frequency and frequency offset.

### NOTE for the USA version transceiver:

When turned ON, the Auto Repeater function has priority over the manual duplex setting. If the transmit frequency changes after setting, the Auto Repeater function may have changed the duplex setting.

### [MENU] > SET > Function > Auto Repeater

1. Push [MENU].
2. Select "Function" in the "SET" menu.



3. Select "Auto Repeater."



4. Select the option to turn ON the Auto Repeater function.

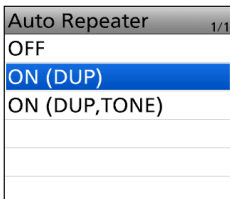

- **OFF:** Turns OFF the function.
- **ON (DUP):** Turns ON only the duplex operation. (Default)
- **ON (DUP, TONE):** Turns ON the duplex operation and Tone encoder.

① To exit the MENU screen, push [MENU].

## Off band indication

If the transmit frequency is out of the amateur band, the off band indication, "OFF BAND," is displayed when you push [PTT]. Check the frequency offset or duplex direction in this case. (p. 11-4)



### Frequency range and offset direction

| Frequency range       | Shift direction |
|-----------------------|-----------------|
| 145.200 ~ 145.495 MHz | "DUP-" is set   |
| 146.610 ~ 146.995 MHz | "DUP-" is set   |
| 147.000 ~ 147.395 MHz | "DUP+" is set   |
| 442.000 ~ 444.995 MHz | "DUP+" is set   |
| 447.000 ~ 449.995 MHz | "DUP-" is set   |

# Section 12 SET MODE

---

|                               |       |
|-------------------------------|-------|
| Selecting an item .....       | 12-2  |
| ◇ MENU screen operation ..... | 12-2  |
| ◇ Selecting an item .....     | 12-3  |
| DUP/TONE.....                 | 12-4  |
| Scan .....                    | 12-5  |
| Scope .....                   | 12-7  |
| Call Sign .....               | 12-8  |
| My Station.....               | 12-9  |
| DV Set .....                  | 12-10 |
| SPEECH.....                   | 12-13 |
| DTMF/T-CALL .....             | 12-14 |
| QSO/RX Log.....               | 12-15 |
| Function.....                 | 12-18 |
| Display.....                  | 12-25 |
| Sounds .....                  | 12-29 |
| Time Set .....                | 12-30 |
| SD Card.....                  | 12-31 |
| Bluetooth Set.....            | 12-32 |
| Others.....                   | 12-36 |

## Selecting an item

You can open the MENU screen by pushing [MENU]. You can use the MENU screen to set infrequently changed values or function settings. In addition to this page, see pages 12-4 through 12-36 for details of each item's options and default values.

### ◇ MENU screen operation

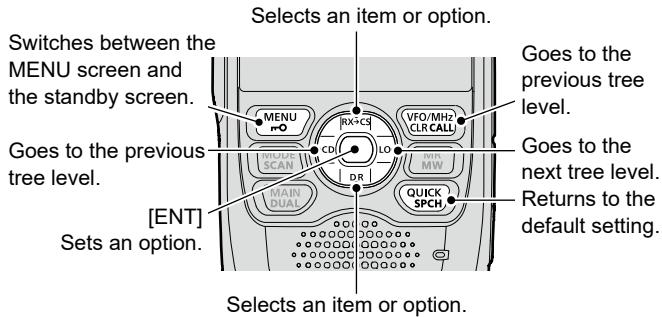

### Simplified description—'Select' operation

In this manual, the user's 'Select' operation is simplified, as described below.

#### Simplified description:

1. Push [MENU].
2. Select "30min."

#### Operation:

1. Push [MENU] to open the MENU screen.
2. Push D-pad(↑) to select "30min," and then push [ENT].

**TIP:** The MENU screen is constructed in a tree structure. You may go to the next tree level, or go back a level, depending on the selected item.

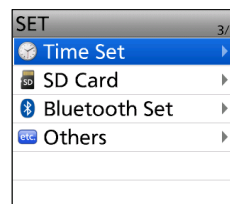
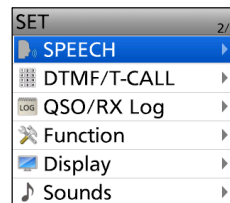
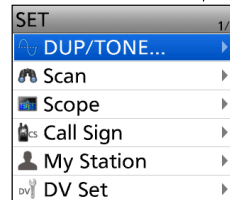
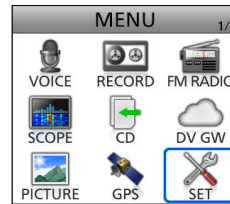

# 12 SET MODE

## Selecting an item

### ◇ Selecting an item

**Example:** Set “Auto Power OFF” to “30 min.”

[MENU] > SET > Time Set > **Auto Power OFF**

1. Push [MENU].
2. Select “SET.”
3. Select “Time Set.”

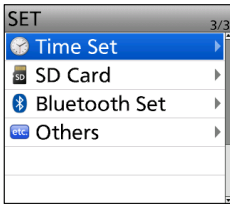

4. Select “Auto Power OFF.”

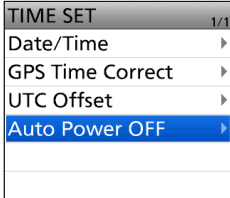

5. Select “30min.”

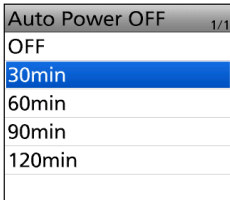

- Sets the option, then goes back to a tree level.  
(The TIME SET screen is displayed.)
- ① To exit the MENU screen, push [MENU].

#### **TIP: To return to the default setting**

1. Push [QUICK] in step 5.
2. Select “Default.”

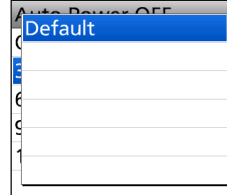

- The setting returns to the default.

# 12 SET MODE

**NOTE:** The default settings shown below are for the USA transceiver version. The default settings may differ, depending on your transceiver version.

## DUP/TONE...

### Offset Freq (Default: 0.600.00\*)

[MENU] > SET > DUP/TONE... > **Offset Freq**

Sets the frequency offset for Duplex (repeater) operation to between 0.000.00 and 59.995.00 MHz.

- ① Push [VFO/MHz] to select the 1 MHz tuning step.
- ② The Duplex shift direction (DUP-/DUP+) (p. 11-4) or the tuning step is set in the Quick Menu window.
- ③ When the DR function is ON, editing is disabled.

\* The default value may differ, depending on the frequency band (selected as the MAIN band before entering the MENU screen) and the transceiver version.

### Repeater Tone (Default: 88.5)

[MENU] > SET > DUP/TONE... > **Repeater Tone**

Selects a repeater tone frequency for repeater access and other functions.

You can select 50 tone frequencies (67.0 ~ 254.1 Hz).

### TSQL Freq (Default: 88.5)

[MENU] > SET > DUP/TONE... > **TSQL Freq**

Selects a CTCSS tone frequency for the Tone Squelch function.

You can select 50 tone frequencies (67.0 ~ 254.1 Hz).

#### • Selectable Repeater Tone/TSQL frequencies (Unit: Hz)

|      |       |       |       |       |       |       |
|------|-------|-------|-------|-------|-------|-------|
| 67.0 | 88.5  | 114.8 | 151.4 | 177.3 | 203.5 | 250.3 |
| 69.3 | 91.5  | 118.8 | 156.7 | 179.9 | 206.5 | 254.1 |
| 71.9 | 94.8  | 123.0 | 159.8 | 183.5 | 210.7 |       |
| 74.4 | 97.4  | 127.3 | 162.2 | 186.2 | 218.1 |       |
| 77.0 | 100.0 | 131.8 | 165.5 | 189.9 | 225.7 |       |
| 79.7 | 103.5 | 136.5 | 167.9 | 192.8 | 229.1 |       |
| 82.5 | 107.2 | 141.3 | 171.3 | 196.6 | 233.6 |       |
| 85.4 | 110.9 | 146.2 | 173.8 | 199.5 | 241.8 |       |

### Tone Burst (Default: OFF)

[MENU] > SET > DUP/TONE... > **Tone Burst**

Turns the Tone Burst function ON or OFF in the FM mode when using the Tone Squelch function.

- OFF: When you transmit a signal that superimposes the CTCSS tone, the other station may hear a short burst of noise from their receiver, just after you stop transmitting.
- ON: When you transmit a signal that superimposes the CTCSS tone, the function mutes the noise from being heard in the other station's receiver.

### DTCS Code (Default: 023)

[MENU] > SET > DUP/TONE... > **DTCS Code**

Selects a DTCS (both encoder/decoder) code for the DTCS Squelch.

You can select a total of 104 codes (023 ~ 754).

#### • Selectable DTCS codes

|     |     |     |     |     |     |     |     |
|-----|-----|-----|-----|-----|-----|-----|-----|
| 023 | 072 | 152 | 244 | 311 | 412 | 466 | 631 |
| 025 | 073 | 155 | 245 | 315 | 413 | 503 | 632 |
| 026 | 074 | 156 | 246 | 325 | 423 | 506 | 654 |
| 031 | 114 | 162 | 251 | 331 | 431 | 516 | 662 |
| 032 | 115 | 165 | 252 | 332 | 432 | 523 | 664 |
| 036 | 116 | 172 | 255 | 343 | 445 | 526 | 703 |
| 043 | 122 | 174 | 261 | 346 | 446 | 532 | 712 |
| 047 | 125 | 205 | 263 | 351 | 452 | 546 | 723 |
| 051 | 131 | 212 | 265 | 356 | 454 | 565 | 731 |
| 053 | 132 | 223 | 266 | 364 | 455 | 606 | 732 |
| 054 | 134 | 225 | 271 | 365 | 462 | 612 | 734 |
| 065 | 143 | 226 | 274 | 371 | 464 | 624 | 743 |
| 071 | 145 | 243 | 306 | 411 | 465 | 627 | 754 |

### DTCS Polarity (Default: Both N)

[MENU] > SET > DUP/TONE... > **DTCS Polarity**

Selects the DTCS polarity to use for transmitting (TX) and receiving (RX).

- Both N: Normal polarity is used for both TX and RX.
- TN-RR: Normal polarity is used for TX, Reverse polarity for RX.
- TR-RN: Reverse polarity is used for TX, Normal polarity for RX.
- Both R: Reverse polarity is used for both TX and RX.

### Digital Code (Default: 00)

[MENU] > SET > DUP/TONE... > **Digital Code**

Selects the digital code for Digital Code Squelch.

You can select a total of 100 codes (00 ~ 99).

## Scan

### Pause Timer (Default: 10sec)

[MENU] > SET > Scan > **Pause Timer**

Selects the Scan Pause Timer. When receiving a signal, the scan pauses for this set period of time.

- ① Individually selectable for A band and B band.
- 2sec ~ 20sec: When a signal is received, the scan pauses for 2 ~ 20 seconds (in 2 second steps).
- HOLD: The scan pauses on a received signal until the signal disappears.

### Resume Timer (Default: 2sec)

[MENU] > SET > Scan > **Resume Timer**

Selects the scan Resume Timer. When a received signal disappears, the scan resumes for this set period of time.

- ① Individually selectable for A band and B band.
- 0sec: The scan resumes immediately after the signal disappears.
- 1sec ~ 5sec: The scan resumes 1 ~ 5 seconds after the signal disappears.
- HOLD: The scan remains paused for the "Pause Timer" setting, even if the signal disappears.

**NOTE:** Rotate [DIAL] to resume the scan.

### Temporary Skip Timer (Default: 5min)

[MENU] > SET > Scan > **Temporary Skip Timer**

Selects the effective time of the Temporary Skip function.

- ① Individually selectable for A band and B band.
- ① This timer is activated for the VFO scan, Memory scan, and DR scan.
- 5min/10min/15min: The Temporary Skip channels are skipped for the set period of time.
- While Scanning: The Temporary Skip channels are skipped until the Scan is stopped.
- While Powered ON: The Temporary Skip channels are skipped until the transceiver is turned OFF.

### Program Skip (Default: ON)

[MENU] > SET > Scan > **Program Skip**

Turns the Program Skip Scan function ON or OFF for a VFO scan. This function enables the transceiver to skip the unwanted frequencies that are entered as a Memory channel and are set to "PSKIP."

- ① Individually selectable for A band and B band.
- OFF: The transceiver scans all frequencies.
- ON: The transceiver does not scan frequencies set as "PSKIP" frequencies.

### Group Link (Default: 00 ~ 99/ S: SKIP CH)

[MENU] > SET > Scan > **Group Link**

Selects groups to be scanned during a Group Link Scan. The Group Link function scans all channels in the selected groups.

Select a group, A ~ Z, and then push [ENT] to turn the Link function ON or OFF.

- ① Displays "✓" when the function is set to ON.
- ① Individually selectable for A band and B band.

### P-Scan Edge

[MENU] > SET > Scan > **P-Scan Edge**

You can delete, copy, or edit the upper and lower frequencies for programmed scans.

The transceiver has a total of up to 25 frequency ranges (00 ~ 24), and you can set the scan name, tuning step, and operating mode for each scan edge.

- ① The default setting may differ, depending on the transceiver version.

## Scan

### Program Link

[MENU] > SET > Scan > **Program Link**

Sets the link function for two or more Program Scan Edge ranges to be sequentially scanned during a Program Link Scan. The link function scans all frequencies in the scan range.

#### Default settings of the Program Link:

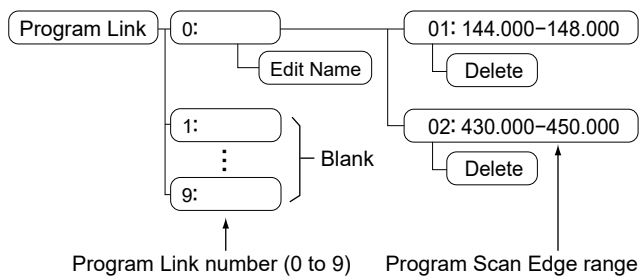

- ① The default setting may differ, depending on the transceiver version.
- ① When only one Program Scan Edge range is entered, or there is no Programmed Scan Edge is left, "Add" is not displayed after pushing [QUICK].

### DUP Check During MR Scan (Default: OFF)

[MENU] > SET > Scan > **DUP Check During MR Scan**

During a Memory scan, selects whether or not to scan the offset frequency if Duplex is set on the channel.

- OFF: The offset frequency is not scanned.
- ON: The offset frequency is also scanned.

## Scope

### Scope Mode (Default: Center)

[MENU] > SET > Scope > **Scope Mode**

Selects the Band Scope display mode.

- Center: Displays signals around the operating frequency within the selected span. The operating frequency is always displayed in the center of the screen.
- FIX: Displays signals within a specified frequency range.
- Scroll (FIX): Displays signals within a specified frequency range. When the operating frequency moves outside of the screen, the displayed frequency range is automatically shifted.

### Displayed Steps (Default: ±15 Steps)

[MENU] > SET > Scope > **Displayed Steps**

Selects the number of displayed steps around the center frequency in the Band scope.

① The tuning step depends on the TS setting.

- ±15 Steps:



- ±20 Steps:



### Waterfall Function (Default: ON)

[MENU] > SET > Scope > **Waterfall Function**

Selects whether or not to use the waterfall display in the single display when the Band Scope function is ON.

- OFF: Turns OFF the Waterfall display.
- ON: Turns ON the Waterfall display.

### Waterfall Speed (Default: Fast)

[MENU] > SET > Scope > **Waterfall Speed**

Selects the waterfall speed.

- Slow: Sets the Waterfall speed to Slow.
- Fast: Sets the Waterfall speed to Fast.

### FIX Mode Center Frequency

[MENU] > SET > Scope > **FIX Mode Center Frequency**

Sets the center frequency of the FIX mode Band Scope for each band.

- ① The selected tuning step in the VFO mode is used to set the center frequency. To select the tuning step, open the Quick Menu window on the Standby screen.
- ① To return to the default setting, push [QUICK], and then select "Default" on the "Center Freq. (FIX)" or "FREQUENCY" screen.
- ① The default setting may differ, depending on the transceiver version.

### AF Output (DUAL/AIR Band) (Default: OFF)

[MENU] > SET > Scope > **AF Output (DUAL/AIR Band)**

Selects whether or not to momentarily output the received audio during a sweep by the Band Scope function, when using the Dualwatch function or selecting the AIR band.

- OFF: No audio is output during the sweep.
- ON: The received audio is momentarily output during the sweep.

## Call Sign

### Call Sign

[MENU] > SET > Call Sign

Set or view the “UR,” “R1,” “R2,” and “MY” call signs to use in the DV mode.

When not using the DR function, sets the call signs on this screen.

#### For Simplex operation (DV mode)

You can set the “UR” and “MY” call signs.

#### For Duplex (repeater) operation (DV mode/DR function)

You can set only the “MY” call sign when the DR function is ON.

#### <To manually set the Duplex (repeater) operation>

**Example:** Making a gateway CQ call to Kirkland repeater (N71H B) from the Hirano repeater (JP3YHH A), in the DV mode.

① Before starting to set the call sign, set the frequency of your Access repeater and duplex direction on the standby screen.

**TIP:** When the Digital Repeater Set function is ON, the repeater call sign is automatically set.  
([MENU] > SET > DV Set > Digital Repeater Set)

#### Step 1. Setting the call sign “R1”

1. Select “R1.”  
① **DO NOT** push [ENT].
2. Push [QUICK].
3. Select “Edit.”
4. Rotate [DIAL] to enter the first character.  
① Selectable characters are alphanumeric characters and symbol (“/”).
5. Push D-pad (↔) to move the cursor.
6. Repeat steps 4 and 5 to enter the repeater call sign of up to 8 characters, including a space.  
(Example: JP3YHH A)
7. After entering, push [ENT].
  - Saves the entered repeater call sign.

#### Step 2. Gateway “R2” setting

1. Select “R2.”  
① To manually enter a call sign, push [QUICK], then select “Edit.”
2. Select “GW.”

#### About the RPT2 SELECT screen

|               |  |
|---------------|--|
| NOT USED*     | For local area calls   |
| GW            | To select the gateway call sign from the repeater list.                |
| Repeater name | To select the repeater that has the same gateway as the “R1” repeater. |

#### Step 3. Destination “UR” setting

1. Select “UR.”  
① To manually enter a call sign, push [QUICK], then select “Edit.”
2. Select “Gateway CQ.”
3. Select a repeater group where your destination repeater is listed.
4. Select a destination repeater.

#### About the YOUR SELECT screen

|                |   |
|----------------|---|
| CQCQCQ         | To select “CQCQCQ” to make a non-call sign specific call.                 |
| Gateway CQ*    | To select “Gateway CQ” to make a call using the repeater list.            |
| Your Call Sign | To select the destination “UR” call sign using the Your Call Sign memory. |
| RX History     | To select the destination “UR” call sign using RX History.                |
| TX History     | To select the destination “UR” call sign using TX History.                |

\* Not displayed in the Simplex mode.

## My Station

### My Call Sign

[MENU] > SET > My Station > **My Call Sign**

The transceiver has a total of 6 memories to save your own call signs for use in the DV mode. You can enter a call sign of up to 8 digits.

Also, you can enter a note of up to 4 characters, for operating transceiver type, area, and so on.

- ① See D-STAR GUIDE in the Basic manual for MY Call Sign entry.
- ① To select another My Call Sign, push D-pad(↑) to select a call sign, and then push [ENT] on the MY CALL SIGN screen.

### TX Message

[MENU] > SET > My Station > **TX Message**

The transceiver has a total of 5 memories to save short messages for transmission with your voice signal in the DV mode.

Enter a message of up to 20 alphanumeric characters for each memory.

- ① See page 5-17 for TX message entry.
- ① To select other TX message, push D-pad(↑) to select a memory, and then push [ENT] on the TX MESSAGE screen.

**TIP:** To transmit no message, select "OFF."

## DV Set

### RX Bass (Default: Normal)

[MENU] > SET > DV Set > Tone Control > **RX Bass**

Selects the receive audio bass filter level.

- Cut: Reduces low frequencies.
- Normal: Normal tone balance.
- Boost: Increases low frequencies.

### RX Treble (Default: Normal)

[MENU] > SET > DV Set > Tone Control > **RX Treble**

Selects the receive audio treble filter level.

- Cut: Reduces high frequencies.
- Normal: Normal tone balance.
- Boost: Increases high frequencies.

### RX Bass Boost (Default: OFF)

[MENU] > SET > DV Set > Tone Control > **RX Bass Boost**

Turns the Receive Audio Bass Boost function ON or OFF.

- ① This function is different from the “Boost” setting of “RX Bass.”
- OFF: Turns OFF the function.
- ON: This function boosts the receive audio bass.

### TX Bass (Default: Normal)

[MENU] > SET > DV Set > Tone Control > **TX Bass**

Selects the transmit audio bass filter level.

- Cut: Reduces low frequencies.
- Normal: Normal tone balance.
- Boost: Increases low frequencies.

### TX Treble (Default: Normal)

[MENU] > SET > DV Set > Tone Control > **TX Treble**

Selects the transmit audio treble filter level.

- Cut: Reduces high frequencies.
- Normal: Normal tone balance.
- Boost: Increases high frequencies.

### Auto Reply (Default: OFF)

[MENU] > SET > DV Set > **Auto Reply**

Selects an option for the Automatic Reply function in the DV mode. This function automatically replies to a call addressed to your own call sign (MY), even if you are away from the transceiver.

- OFF: Turns OFF the function.
  - ON: Replies with your own call sign (MY). (No audio reply is sent)
  - Voice: Replies with your call sign (MY) and any Auto Reply message recorded on the microSD (up to 10 seconds).
    - ① The transmitted audio can be monitored.
    - ① If no microSD card is inserted, or no message is recorded, only your call sign is transmitted.
  - Position: Replies with your own call sign and transmits your position data using the internal GPS receiver.
    - ① When “GPS Select” is set to “OFF” or “Manual,” the internal GPS receiver is temporarily turned ON.
- ① When “ON” or “Voice” is selected, the Automatic Reply function is automatically turned OFF when you push [PTT]. When “Position” is selected, the Automatic Reply function is not turned OFF, even if you push [PTT].

### DV Data TX (Default: Auto)

[MENU] > SET > DV Set > **DV Data TX**

Selects whether to manually or automatically transmit data in the DV mode.

- PTT: Push [PTT] to manually transmit data.
- Auto: When data is input from a PC through the [USB] port, the transceiver automatically transmits it.

### Fast Data (Default: OFF)

[MENU] > SET > DV Set > DV Fast Data > **Fast Data**

Selects whether or not to use the DV Fast Data function for data communication in the DV mode. The DV Fast Data function uses the data and the audio frames to send data approximately 3.5 times faster than the normal speed. So, no audio can be sent.

- OFF: Sends data at a slow speed (approximately 950 bps).
  - ON: Sends data at a fast speed (approximately 3480 bps).
- ① Even if “ON” is selected, when you push [PTT], the data is sent at the slow speed, because the audio frame is used for the audio transmission.
- ① The GPS data speed is set in “GPS Data Speed.”

# 12 SET MODE

## DV Set

### GPS Data Speed (Default: Slow)

[MENU] > SET > DV Set > DV Fast Data > **GPS Data Speed**

Sets the GPS data speed when the data is sent using the DV Fast Data function.

- Slow: Sends GPS data at slow speed (approximately 950 bps).
- Fast: Sends GPS data at fast speed (approximately 3480 bps).

### TX Delay (PTT) (Default: 2sec)

[MENU] > SET > DV Set > DV Fast Data > **TX Delay (PTT)**

Sets the time for when the transceiver returns to receive after sending DV data in the DV Fast Data mode using [PTT].

- OFF: After releasing [PTT], the transceiver returns to receive.
- 1 ~ 10sec: After releasing [PTT], the transceiver sends data using the DV Fast Data mode for this set period. When the TX data is completely sent within this set period, the transceiver automatically returns to receive.

**NOTE:** This function is usable only when “DV Data TX” is set to “PTT.”

### Digital Monitor (Default: Auto)

[MENU] > SET > DV Set > **Digital Monitor**

Selects a receive mode when pushing [SQL] in the DV mode.

- Auto: Receives in the DV mode or the FM mode, depending on the received signal.
- Digital: Receives in the DV mode.
- Analog: Receives in the FM mode.

### Digital Repeater Set (Default: ON)

[MENU] > SET > DV Set > **Digital Repeater Set**

Turns the Digital Repeater Set function ON or OFF. When accessing a repeater that has a call sign that is different from the transceiver’s setting, this function reads the repeater’s transmit signal and automatically sets the repeater call sign.

- OFF: Turns OFF the function.
- ON: Automatically sets the repeater call sign.

### DV Auto Detect (Default: OFF)

[MENU] > SET > DV Set > **DV Auto Detect**

Turns the DV mode Automatic Detect function ON or OFF. When in the DV mode, if you receive a non-digital signal, this function automatically sets the operating mode to the FM mode.

- OFF: Turns the function OFF. The operating mode is fixed to the DV mode.
- ON: Automatically selects the FM mode for temporary operation.

### RX Record (RPT) (Default: ALL)

[MENU] > SET > DV Set > **RX Record (RPT)**

The transceiver can record the data of up to 50 individual calls. When the received signal includes a status message (“UR?” or “RPT?”) that is sent back from the access repeater, you can record up to 50 messages, or only the last call, in the Received Call Record.

- ALL: Records up to 50 calls.
- Latest Only: Records only the last call.

### [RX>CS] Key (Default: Call Sign Capture)

[MENU] > SET > DV Set > **[RX>CS] Key**

Selects the [RX→CS] Call Sign Capture key operation when you hold down.

- Call Sign Capture: While holding down, the RX History is displayed. After releasing, the last received call station’s call sign is set to “TO” (destination).
- RX>CS List: When you hold down for 1 second, the RX History is displayed. Rotate [DIAL] to select a call sign to set to “TO” (destination), and then push [ENT].

### BK (Default: OFF)

[MENU] > SET > DV Set > **BK**

The Break-in (BK) function enables you to break into a conversation, where the two other stations are communicating with call sign squelch enabled.

- OFF: Turns OFF the function.
- ON: Turns ON the function.

④ The BK function is automatically turned OFF when the transceiver is turned OFF.

---

# 12 SET MODE

## DV Set

### **EMR** (Default: OFF)

[MENU] > SET > DV Set > **EMR**

The Enhanced Monitor Request (EMR) function enables all transceivers that receive an EMR signal in the DV mode automatically to open their squelch to receive the signal.

- OFF: Turns OFF the function.
- ON: Turns ON the function.

① The EMR function is automatically turned OFF when the transceiver is turned OFF.

### **EMR AF Level** (Default: 19)

[MENU] > SET > DV Set > **EMR AF Level**

Sets the audio output level when an EMR communication mode signal is received. When an EMR signal is received, the audio will be heard at the programmed level, or the transceiver's audio level, whichever is higher.

To disable the setting, set to "0."

**NOTE:** After an EMR signal disappears, the audio level will remain at the EMR level. In this case, rotate [VOL] to adjust the audio level.

## SPEECH

### RX Call Sign SPEECH (Default: ON (Kerchunk))

[MENU] > SET > SPEECH > **RX Call Sign SPEECH**

Turns the RX Call Sign Speech function ON or OFF for calls received in the DV mode.

#### ① Information

- When the Digital Squelch function is used, the calling station's call sign is not announced if the received signal is not addressed to your call sign, or does not include a matching digital code.
- When you receive a signal from a repeater ("UR?" or "RPT?"), the caller station's call sign is not announced.
- While scanning, the transceiver resumes the scan during an announcement.
- Even if a note is entered after the call sign, it is not announced.
- When you receive a signal during an announcement, the transceiver cancels the announcement, and you can hear the received audio.
- OFF: The caller station's call sign is not announced, even when a call is received.
- ON (Kerchunk): The caller station's call sign is announced only when they make a quick transmission.
- ON (All): The caller station's call sign is always announced.

### RX>CS SPEECH (Default: ON)

[MENU] > SET > SPEECH > **RX>CS SPEECH**

Turns the RX>CS Speech function ON or OFF. The RX>CS Speech function announces the station call sign that is selected from a Received Call Record by pushing [RX→CS].

① If a call is received during an announcement, the received audio is muted, and the audio is not recorded onto the microSD card.

- OFF: The station call sign is not announced.
- ON: The station call sign is announced.

### DIAL SPEECH (Default: OFF)

[MENU] > SET > SPEECH > **DIAL SPEECH**

Turns the Dial Speech function ON or OFF. The Dial Speech function announces the frequency or repeater call sign that is selected by rotating [DIAL].

- ① When using the DR function, the frequency is announced if the Simplex mode is selected or the FM repeater does not have a call sign.
- ① When you receive a signal during an announcement, the transceiver cancels the announcement, and you can hear the received audio.

- OFF: The frequency or repeater call sign is not announced.
- ON: The frequency or repeater call sign is announced, 1 second after rotating [DIAL]. In the VFO, Memory, or Call Channel mode, the frequency is announced. When using the DR function, the repeater call sign is announced.

### MODE SPEECH (Default: OFF)

[MENU] > SET > SPEECH > **MODE SPEECH**

Turns the operating mode announcement ON or OFF.

- ① During a VFO scan, the operating mode is announced when you change the mode.
- OFF: The selected operating mode is not announced.
- ON: The selected operating mode is announced.

### SPEECH Language (Default: English)

[MENU] > SET > SPEECH > **SPEECH Language**

Sets the speech language to English or Japanese.

### Alphabet (Default: Normal)

[MENU] > SET > SPEECH > **Alphabet**

Selects the type of phonetic announcement.

- Normal: Normal code is used. (Example: A as eh, B as bee)
- Phonetic Code: The Phonetic code is used. (Example: A as Alfa, B as Bravo)

# 12 SET MODE

## SPEECH

### **SPEECH Speed** (Default: Fast)

[MENU] > SET > SPEECH > **SPEECH Speed**

Sets the speech speed to Fast or Slow.

### **SPEECH Level** (Default: 7)

[MENU] > SET > SPEECH > **SPEECH Level**

Sets the Voice Synthesizer audio output level to between 0 (OFF), 1 (minimum) and 9 (maximum).

① The voice synthesizer audio output level is linked with the [VOL] setting from the minimum audio volume up to this set level.

## DTMF/T-CALL

You can set the DTMF tone code and DTMF Memory channel for DTMF tone operation.

See page 15-5 for details.

### **DTMF Memory** (Default: d0)

[MENU] > SET > DTMF/T-CALL > **DTMF Memory**

Displays a list of the DTMF Memory channels.

- T-CALL: 1750 Hz tone burst signal
- d0 ~ d#: DTMF memory channel list

### **DTMF Speed** (Default: 100ms)

[MENU] > SET > DTMF/T-CALL > **DTMF Speed**

Selects the DTMF transmit speed.

- 100ms: Transmits the DTMF codes at about 100 milliseconds per code (5 characters per second).
- 200ms: Transmits the DTMF codes at about 200 milliseconds per code (2.5 characters per second).
- 300ms: Transmits the DTMF codes at about 300 milliseconds per code (1.6 characters per second).
- 500ms: Transmits the DTMF codes at about 500 milliseconds per code (1 character per second).

## QSO/RX Log

### QSO Log (Default: ON)

[MENU] > SET > QSO/RX Log > **QSO Log**

Selects whether or not to make a communication log on a microSD card. The communication log is made on the card, and saved in the “csv” format.

① This function requires a microSD card (User supplied).

- OFF: The QSO Log function is OFF.
- ON: The transceiver makes a log on the microSD card. The transceiver starts making a log when you begin talking.

#### TIP:

- The folder name is automatically created, as [ID-52\QsoLog].
- The file name is automatically created, as shown in the example below:  
Log start date and time: 1st November 2021 15:30:00  
File name: 20211101\_153000.csv
- The log contents are not displayed on the transceiver.
- You can display the log contents on a PC.

### RX History Log (Default: OFF)

[MENU] > SET > QSO/RX Log > **RX History Log**

Selects whether or not to make a DV mode’s receive history log on a microSD card. The receive history log is made on a microSD card, and saved in the “csv” format.

① This function requires a microSD card (User supplied).

- OFF: The RX History Log function is OFF
- ON: The transceiver makes a DV mode’s receive history log on the microSD card. The transceiver starts making a receive history log when you finish talking.

#### TIP:

- The folder name is automatically created, as [ID-52\RxLog].
- The file name is automatically created, as shown in the example below:  
Log start date and time: 1st November 2021 15:30:00  
File name: 20211101\_153000.csv
- The log contents are not displayed on the transceiver.
- You can display the log contents on a PC.

### Separator/Decimal (Default: Sep[,.] Dec[.])

[MENU] > SET > QSO/RX Log > CSV Format > **Separator/Decimal**

Selects the separator and the decimal character for the CSV format.

① The default value may differ, depending on the transceiver version.

- Sep [,] Dec [.]: Separator is “,” and Decimal is “.”
- Sep [.] Dec [.]: Separator is “;” and Decimal is “.”
- Sep [.] Dec [,]: Separator is “;” and Decimal is “,”

### Date (Default: mm/dd/yyyy)

[MENU] > SET > QSO/RX Log > CSV Format > **Date**

Selects the date format between “yyyy/mm/dd,” “mm/dd/yyyy,” and “dd/mm/yyyy.”

(y: year, m: month, d: day)

① The default value may differ, depending on the transceiver version.

# 12 SET MODE

## QSO/RX Log

The call log contents are shown below:

| Contents      | Example             |                     | Descriptions  |
|---------------|---------------------|---------------------|---|
| TX/RX         | TX                  | RX                  | Transmission and reception  |
| Date          | 11/01/2021 13:51:48 | 11/01/2021 13:51:48 | Date and time the call was started.   |
| Frequency     | 438.010000          | 438.010000          | Operating frequency   |
| Mode          | DV                  | DV                  | Operating mode (FM/FM-N/DV)   |
| My Latitude   | 34.764667           | 34.764667           | Your latitude (unit: degrees)<br>(+: North latitude, -: South latitude)   |
| My Longitude  | 135.375333          | 135.375333          | Your longitude (unit: degrees)<br>(+: East longitude, -: West longitude)  |
| My Altitude   | 50.5                | 50.5                | Your altitude (unit: meters)<br>Records to one decimal place.   |
| RF Power      | LOW                 | (Blank)             | TX output power level   |
| S meter       | (Blank)             | S0                  | The relative signal strength of the receive signal<br>(in 14 levels)  |
| RPT Call Sign | JP3YHJ              | JP3YHJ A            | Repeater call sign (DV mode only)   |
| TX Call Sign  | CQCQCQ              | (Blank)             | TX Call sign (DV mode only)   |
| RX Call Sign  | (Blank)             | JA3YUA A/52         | RX Call sign/Note (DV mode only)  |
| RX Latitude   | (Blank)             | 34.764667           | Caller's latitude, if sent. (unit: degrees)<br>(+: North latitude, -: South latitude)<br>Records only when you receive in the DV mode.  |
| RX Longitude  | (Blank)             | 135.375333          | Caller's longitude, if sent. (unit: degrees)<br>(+: East longitude, -: West longitude)<br>Records only when you receive in the DV mode. |
| RX Altitude   | (Blank)             | 30.5                | Caller's altitude, if sent. (unit: meters)<br>Records only when you receive in the DV mode.   |

# 12 SET MODE

## QSO/RX Log

The RX log contents are shown below:

| Contents            | Example             | Descriptions  |
|---------------------|---------------------|---|
| Frequency           | 438.010000          | RX Frequency  |
| Mode                | DV                  | Operating mode (DV mode is fixed)   |
| Caller              | JA3YUAA             | Call sign of the caller station (up to 8 characters)  |
| /                   | ID52                | Note after the call sign (up to 4 characters)   |
| Called              | CQCQCQ              | Call sign of the called station   |
| Rx RPT1             | JP3YHH G            | Access repeater call sign of the caller station, or the gateway repeater call sign of your local area repeater. |
| Rx RPT2             | JP3YHH A            | Access repeater call sign of the called station   |
| Message             | Hello CQ D-STAR!    | Message included in the received call (up to 20 characters)   |
| Status              | (Blank)             | Normal: blank, Uplink: "RPT UP", Access repeater reply: "UR?" or "RPT?"   |
| Received date       | 11/01/2021 13:51:48 | Date and time the call was received<br>The format may differ, depending on the setting.                         |
| BK                  | *                   | BK call: "*", Normal call: Blank  |
| EMR                 | *                   | EMR call: "*", Normal call: Blank   |
| Latitude            | 34.764667           | Caller's latitude, if sent. (unit: degrees) (+: North latitude, -: South latitude)                              |
| Longitude           | 135.375333          | Caller's longitude, if sent. (unit: degrees) (+: East longitude, -: West longitude)                             |
| Altitude            | 30.5                | Caller's altitude, if sent. (unit: meters) Records to one decimal place.  |
| SSID                | -A                  | Caller's SSID, if sent. (0, -1 to -15, -A to -Z)  |
| D-PRS Symbol        | Car                 | Icon: Converts to text, None: Code  |
| Course              | 123                 | Caller's course (unit: degrees)   |
| Speed               | 23.5                | Caller's speed (unit: km/h) Records to one decimal place.   |
| Power               | 49                  | TX power (unit: watts)  |
| Height              | 24                  | Antenna height (unit: meters)   |
| Gain                | 6                   | Antenna gain (unit: dB)   |
| Directivity         | Omni                | Antenna directivity (Omni, 45, 90, 135, 180, 225, 270, 315, or 360)   |
| Object/Item Name    | HAM FES             | Object name or Item name (up to 9 characters)   |
| Data Type           | Live Object         | Data type of Object or Item (Live or Kill)  |
| Temperature         | 20.5                | Temperature (unit: °C) Records to two decimal places.   |
| Rainfall            | 253.75              | Rainfall (unit: mm) Records to two decimal places.  |
| Rainfall (24 Hours) | 253.75              | Rainfall (24 Hours) (unit: mm) Records to two decimal places.   |
| Rainfall (Midnight) | 253.75              | Rainfall (Midnight) (unit: mm) Records to two decimal places.   |
| Wind Direction      | 315                 | Wind Direction (unit: degrees)  |
| Wind Speed          | 10.0                | Wind Speed (unit: m/s) Records to one decimal place.  |
| Gust Speed          | 10.0                | Gust Speed (unit: m/s) Records to one decimal place.  |
| Barometric          | 1013.0              | Barometric (unit: hPa) Records to one decimal place.  |
| Humidity            | 85                  | Humidity (unit: %)  |
| GPS Time Stamp      | 12:00:00            | Time data that the caller station acquires along with the position data   |
| GPS Message         | Osaka City/ID-52    | Caller is "NMEA": Records the GPS message<br>Caller is "D-PRS": Records the D-PRS comment                       |

## Function

### Power Save (Default: Auto (Short))

[MENU] > SET > Function > **Power Save**

Sets the Power Save function to reduce the current drain and conserve battery power. When the Power Save function is activated, the call sign or the beginning of the signal may not be received correctly.

- OFF: Turns OFF the function.
- Auto (Short): Sets the Power saving time to "Short."

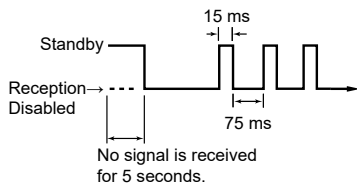

- Auto (Middle): Sets the Power saving time to "Middle."

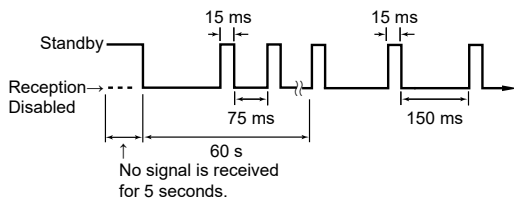

- Auto (Long): Sets the Power saving time to "Long."

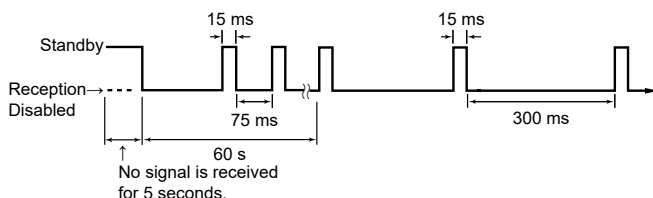

**NOTE:** The Power Save function is disabled when:

- Using an external DC power source.
- Scanning.
- Using the DV Gateway function.
- Using the VOX function.

### Monitor (Default: Push)

[MENU] > SET > Function > **Monitor**

Selects an option for the [SQL] Monitor function. (Basic manual Section 3)

- Push: Hold down [SQL] to monitor the frequency. Release to stop monitoring.
- Hold: Push [SQL] momentarily to monitor the frequency and push momentarily again to cancel it.

### Dial Speed-UP (Default: ON)

[MENU] > SET > Function > **Dial Speed-UP**

Turns the Dial Speed Acceleration ON or OFF. The acceleration automatically increases the tuning speed when you rapidly rotate [DIAL].

- OFF: Turns OFF the function.
- ON: Turns ON the function.

### Auto Repeater (Default: ON (DUP))

[MENU] > SET > Function > **Auto Repeater**

The Auto repeater function automatically turns the duplex operation and tone encoder ON or OFF.

① This item is displayed in only the USA version.

- OFF: Turns OFF the function.
- ON (DUP): Turns ON the duplex settings only.
- ON (DUP, TONE): Turns ON the duplex settings and the tone encoder function.

### Remote MIC Key

[MENU] > SET > Function > **Remote MIC Key**

The function assignments for the [A], [B], [Δ], and [▽] keys on the optional HM-75LS REMOTE CONTROL SPEAKER MICROPHONE can be changed.

See pages 12-19 and 12-20 for the assignable key functions.

- During RX/Standby: The assigned key function is enabled while receiving or in the standby mode. (Default: [A]: BAND [B]: VFO/MR [Δ]: UP [▽]: DOWN)
- During TX: The assigned key function is enabled while transmitting. (Default: [A]: T-CALL [B]: --- [Δ]: --- [▽]: ---)

#### TIP: Volume level adjustment while monitoring

- When "VOL UP"/"VOL DOWN" are assigned, push these keys to adjust the volume level.
- When "VOL UP"/"VOL DOWN" are not assigned, but "UP"/"DOWN" are assigned, push these keys to adjust the volume level.
- When "VOL UP"/"VOL DOWN"/"UP"/"DOWN" are not assigned, push [Δ]/[▽] to adjust the volume level, if "Monitor (Push)" or "Monitor (Hold)" is not assigned to [Δ]/[▽].

# 12 SET MODE

## Function

### The assignable key functions

- During RX/Standby

| Function       | Descriptions  |
|----------------|---|
| ---            | No function   |
| UP             | Push to increase the frequency, Memory channel, repeater, or station call sign.   |
| DOWN           | Push to decrease the frequency, Memory channel, repeater, or station call sign.   |
| VOL UP         | Push to increase the volume level.  |
| VOL DOWN       | Push to decrease the volume level.  |
| SQL UP         | Push to increase the squelch level.   |
| SQL DOWN       | Push to decrease the squelch level.   |
| Monitor (Push) | Hold down to open the squelch. Release to close the squelch.  |
| Monitor (Hold) | Push to open or close the squelch.  |
| CALL           | Push to select a Call Channel mode.   |
| MR (00-00 CH)  | In the Memory mode, push to select Memory channel 00-00.  |
| MR (00-01 CH)  | In the Memory mode, push to select Memory channel 00-01.  |
| VFO/MR         | Push to select the VFO mode and the Memory mode.  |
| DR             | Push to turn the DR function ON or OFF.   |
| FROM (DR)      | In the DR screen, push to select "FROM."  |
| TO (DR)        | In the DR screen, push to select "TO."  |
| Home CH        | Push to directly select the Home Channel that is set to the selected mode (VFO/Memory) or DR screen.<br>① While in the Call Channel mode, or when no Home CH is set, an error beep sounds.  |
| BAND           | Push to select an operating band.   |
| SCAN           | Push to start the previously selected scan. While scanning, push to stop the scan.  |
| Temporary Skip | Push to set the frequency to be skipped while scanning.<br>The selected frequencies are temporarily skipped for faster scanning.  |
| RX>CS          | Hold down for 1 second to set the last calling station's call sign to "TO" (destination).<br>① If "[RX→CS] Key" is set to "RX > CS List," the received call sign is not captured. The RX History list is displayed instead.<br>② To select the call sign in the RX History using the optional remote control speaker microphone, assign "UP"/"DOWN."  |
| SPEECH         | <ul style="list-style-type: none"> <li>• In the VFO, Memory, or Call Channel mode, push to announce the frequency and operating mode.</li> <li>• In the DR screen, push to announce the call sign.</li> <li>① If the Simplex mode is selected, the frequency is announced.</li> <li>If the FM repeater is selected, the frequency and operating mode, or the call sign and operating mode are announced.</li> </ul> |
| MAIN/DUAL      | <ul style="list-style-type: none"> <li>• Push to set the A or B band as the MAIN band.</li> <li>• Hold down for 1 second to turn the Dualwatch function ON or OFF.</li> </ul>   |
| MODE           | Push to select the operating mode.  |
| LOW            | Push to select the transmit output power.   |
| DUP            | Push to turn the Duplex mode ON or OFF, and the shift direction to DUP+ or DUP-.  |
| TONE/D.SQL     | <ul style="list-style-type: none"> <li>• In the FM/FM-N mode, push to select the tone type.</li> <li>• In the DV mode, push to select the digital squelch type.</li> </ul>  |
| MW             | In the VFO mode or on the DR screen, hold down for 1 second to enter the Memory channel contents to a blank channel.  |
| REC            | <ul style="list-style-type: none"> <li>• Push to start recording.</li> <li>• While recording, hold down for 1 second to stop recording.</li> </ul>  |
| Voice TX       | <ul style="list-style-type: none"> <li>• Push to transmit the voice audio recorded on the microSD card once.</li> <li>• Hold down for 1 second to repeatedly transmit the voice audio.</li> </ul>   |

---

# 12 SET MODE

## Function

### The assignable key functions

- During TX

| Function | Descriptions  |
|----------|---|
| ---      | No function   |
| VOL UP   | Push to increase the volume level.  |
| VOL DOWN | Push to decrease the volume level.  |
| Voice TX | <ul style="list-style-type: none"><li>• Push to transmit the voice audio recorded on the microSD card once.</li><li>• Hold down for 1 second to repeatedly transmit the voice audio.</li></ul> ① To make a repeat transmission, [PTT] must be released after the transmission is started. |
| T-CALL   | Push to transmit a 1750 Hz tone.  |

## Function

### **Key Lock** (Default: Normal)

[MENU] > SET > Function > **Key Lock**

Selects the key lock type when the Key Lock function is ON.

**NOTE:** Regardless of the setting, you can still use [P], [PTT], and [R-O] even if the Key Lock function is ON.

- Normal: All keys and dials, except [SQL] and [VOL] are locked.
- No SQL: All keys and dials, except [SQL] are locked.
- No VOL: All keys and dials, except [VOL] are locked.
- ALL: All keys and dials are locked.

### **PTT Lock** (Default: OFF)

[MENU] > SET > Function > **PTT Lock**

Turns the PTT Lock function ON or OFF. To prevent accidental transmissions, this function inhibits all transmissions.

- OFF: Turns OFF the function.
- ON: Inhibits all transmissions.

### **Busy Lockout** (Default: OFF)

[MENU] > SET > Function > **Busy Lockout**

Turns the Busy Lockout function ON or OFF. This function inhibits a transmission while receiving a signal, or when the squelch is open.

- OFF: Turns OFF the function.
- ON: Turns ON the function.

### **Time-Out Timer** (Default: 5min)

[MENU] > SET > Function > **Time-Out Timer**

To prevent an accidental prolonged transmission, the transceiver has the Time-Out Timer function. The function inhibits continuous transmissions longer than this set period of time.

- OFF: Turns OFF the function.
- 1 to 30 min: The transmission is cut OFF after the set period of time ends (1, 3, 5, 10, 15, or 30 minutes).

### **Active Band** (Default: All)

[MENU] > SET > Function > **Active Band**

Selects whether or not to enable continuous frequency selection of the operating frequency across all bands using [DIAL].

- Single: When you rotate [DIAL] on the band edge, the displayed band's higher or lower frequency is selected.
- All: When you rotate [DIAL] on the band edge, the next band is selected. The selectable frequencies are set to all bands, for continuous selection.
- HAM: When you rotate [DIAL] on the band edge, the amateur band's higher or lower frequency is selected. You cannot select a frequency out of the amateur band.

① To select another band when "Single" is selected, push [QUICK], then select "Band Select."

① This setting is for the [DIAL] operation, so all frequencies are scanned.

### **MIC Gain (Internal)** (Default: 2)

[MENU] > SET > Function > **MIC Gain (Internal)**

Sets the internal microphone gain to between 1 (minimum) and 4 (maximum), to suit your operation needs.

Higher values make the microphone more sensitive to your voice.

### **MIC Gain (External)** (Default: 2)

[MENU] > SET > Function > **MIC Gain (External)**

Sets the external microphone gain to between 1 (minimum) and 4 (maximum), to suit your operation needs.

Higher values make the microphone more sensitive to your voice.

## Function

### VOX (Default: OFF)

[MENU] > SET > Function > VOX > **VOX**

Turns the Voice Operated Transmission (VOX) function ON or OFF.

The VOX function starts transmission without pushing [PTT] when you speak into the microphone, and then, automatically returns to receive when you stop speaking.

- OFF: Turns OFF the function.
- ON: Starts transmission without pushing [PTT] when you speak into the microphone. Then automatically returns to receive when you stop speaking.

### VOX Level (Default: 5)

[MENU] > SET > Function > VOX > **VOX Level**

Sets the VOX gain level to between 1 and 10, or OFF. Higher values make the VOX function more sensitive to your voice.

- OFF: Turns OFF the VOX function.
- 1 ~ 10: 1 (The minimum sensitivity)  
10 (The maximum sensitivity)

### VOX Delay (Default: 0.5sec)

[MENU] > SET > Function > VOX > **VOX Delay**

Sets the VOX Delay to 0.5, 1.0, 1.5, 2.0, 2.5, or 3.0 seconds. The VOX Delay is the amount of time the transmitter stays ON after you stop speaking, before the VOX switches to receive.

### VOX Time-Out Timer (Default: 3min)

[MENU] > SET > Function > VOX > **VOX Time-Out Timer**

Sets the VOX Time-Out Timer to prevent an accidental prolonged transmission. To disable the function, set to "OFF."

- OFF: Turns OFF the function.
- 1, 2, 3, 4, 5, 10, or 15min:  
If a continuous transmission exceeds the set period of time, the transmission is stopped.

### Headset Select (Default: Other)

[MENU] > SET > Function > VOX > **Headset Select**

Selects the headset type to be connected.

- HS-95: Select when using the HS-95.
- Other: Select when using the HS-94 or HS-97.

### CI-V Address (Default: A6)

[MENU] > SET > Function > CI-V > **CI-V Address**

Sets the CI-V address in hexadecimal code.

- ① To distinguish devices, each CI-V transceiver has its own Icom standard address. "A6" is the default address of the ID-52A/ID-52E. When 2 or more ID-52A/ID-52Es are simultaneously controlled by a PC, set a different address for each transceiver between 02 and DF (hexadecimal).

### CI-V Baud Rate (SP Jack) (Default: Auto)

[MENU] > SET > Function > CI-V > **CI-V Baud Rate (SP Jack)**

Sets the CI-V data transfer speed when remotely controlling the transceiver through the [SP] jack, to 4800, 9600, 19200 bps, or Auto. When "Auto" is selected, the baud rate is automatically set according to the controller's data rate.

### CI-V Transceive (Default: OFF)

[MENU] > SET > Function > CI-V > **CI-V Transceive**

Turns the Transceive function ON or OFF.

- ① To use the RS-MS1A or RS-MS1I, set to "ON."

- OFF: The status is not output.
- ON: The status is output. When you change a transceiver setting, the same change is automatically set on other connected transceivers or receivers, and vice versa.

### CI-V USB/Bluetooth→REMOTE Transceive Address (Default: 00)

[MENU] > SET > Function > CI-V > **CI-V USB/Bluetooth→REMOTE Transceive Address**

If you remotely operate your transceiver through a USB cable or using Bluetooth when "CI-V Transceive" is set to ON, the devices in the same system are also externally controlled through the [SP] jack.

To prohibit the external control of an Icom transceiver, set this value to other than "00."

The control signal is output from the [SP] jack.

Select an address between 00 and DF (hexadecimal).

## Function

### USB Connect (Default: Serialport)

[MENU] > SET > Function > **USB Connect**

Selects the mode when connecting the transceiver to a PC with a USB cable.

- Charge Only:  
You can only charge the transceiver using a USB cable.
- Serialport:  
You can program the transceiver, input/output D-STAR data, output GPS information, input weather data, and remotely control the transceiver using the CI-V commands.

#### ① Information

- You need to install the USB driver.
  - When a PC is connected, the USB connection indicator  is displayed on the transceiver.
  - Select the input/output data type in "USB Serialport Function."
  - Confirm that "GPS Select" is set to "ON," when you output the received position data.  
[MENU] > GPS > GPS Set > **GPS Select**
- SD Card Mode:  
You can transfer the files between the inserted microSD card and a PC, using a USB cable.  
① A confirmation dialog is displayed. (p. 2-9)

#### NOTE:

- To charge from a PC, set "USB Power Input (Phone, Tablet, PC)" to "ON."
- Use a data communication compatible USB cable when "Serialport" or "SD Card Mode" is selected.
- While in the SD Card Mode, the transceiver works not as a transceiver but as a data storage device. It temporarily stops recording and logging.

**TIP:** Download the USB driver and the installation guide from the Icom website.  
<https://www.icomjapan.com/support/>

### USB Serialport Function (Default: CI-V (Echo Back OFF))

[MENU] > SET > Function > **USB Serialport Function**

Selects the Serialport function for the USB connection to a data device, PC, and so on.

- CI-V (Echo Back OFF):  
The CI-V command is input or output through the USB port. Does not send back the CI-V command input from the USB port.
- CI-V (Echo Back ON):  
The CI-V command is input or output through the USB port. Sends back the CI-V command input from the USB port.
- DV Data: The DV data is input or output to the USB port.

**NOTE:** When "CI-V (Echo Back OFF)" or "CI-V (Echo Back ON)" is selected, you cannot remotely control the transceiver through the [SP] jack.

### Heterodyne (Default: Normal)

[MENU] > SET > Function > **Heterodyne**

Selects the 1st Local Oscillator frequency. Depending on a combination of the two operating frequencies in the Dualwatch mode, the transceiver might generate a spurious signal on a specific receive frequency. This may cause the S-meter to fluctuate, even when no signal is received, for example. If this occurs, the Heterodyne function may help. The Heterodyne function shifts the 1st Local Oscillator frequency to the opposite side of the signal to change the frequency combination.

# 12 SET MODE

## Function

### Battery Pack Select (Default: BP-271/BP-272)

[MENU] > SET > Function > **Battery Pack Select**

Selects the model of the attached battery pack to display the optimized battery status.

### Battery Pack Confirmation (Default: OFF)

[MENU] > SET > Function > **Battery Pack Confirmation**

Selects whether or not to display the Battery Pack Select dialog the first time the transceiver is turned ON after reattaching a battery pack.

### Charging (Power ON) (Default: ON)

[MENU] > SET > Function > **Charging (Power ON)**

Selects whether or not to charge the battery pack when the optional external DC power cable (CP-12L or OPC-254L) is connected to [DC IN], even if the transceiver is ON.

### USB Power Input (Phone, Tablet, PC) (Default: ON)

[MENU] > SET > Function > **USB Power Input (Phone, Tablet, PC)**

Selects whether or not to use a mobile device or a PC as an external power source.

### Screen Capture [PWR] Key (Default: OFF)

[MENU] > SET > Function > **Screen Capture [PWR] Key**

Assigns the Screen Capture function to [P].

- OFF: [P] does not act as the Screen Capture key.
- ON: Pushing [P] captures the transceiver display onto a microSD card.

### Screen Capture File Type (Default: BMP)

[MENU] > SET > Function > **Screen Capture File Type**

Sets the file format for the Screen Capture function to PNG or BMP.

### LO/CALL Key Actions (Default: Standard)

[MENU] > SET > Function > **LO/CALL Key Actions**

Selects whether or not to change the [CALL], [LO], and [MR] keys operation to the same as the ID-51A/E.

- Standard: The key's operations do not change.
- ID-51 Compatible (CS/LOW):  
The key's operation change as described below.

[CALL]: Hold down for 1 second to change the transmit power levels.

[LO]: In the DV mode, hold down for 1 second to display the CALL SIGN screen.

[MR]: Push to enter the Memory mode, and then push again to enter the Call Channel mode.

#### ① For the ID-52A only

In the Call Channel mode, push to enter the Weather Channel mode.

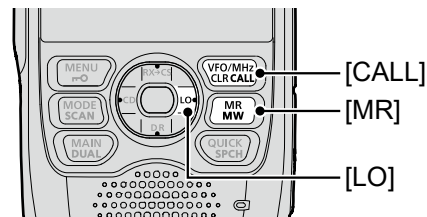

## Display

### Backlight (Default: Auto (DC IN:ON))

[MENU] > SET > Display > **Backlight**

Selects an option for the transceiver backlight.

- OFF: The backlight does not light.
- ON: The backlight lights continuously.
- Auto: The backlight lights when you push a key or rotate [DIAL], and reduces the brightness\* after the set period of time in "Backlight Timer."
- Auto (DC IN:ON):  
The backlight lights when you push a key or rotate [DIAL], and reduces the brightness\* after the set period of time in "Backlight Timer."  
① When an external DC power source is connected, lights continuously.

① When using the GPS Logger Only mode, "Auto" is automatically selected.

\* When "Dim Screen" is set to "OFF," the backlight goes out after the set period of time in "Backlight Timer."

### Backlight Timer (Default: 10sec)

[MENU] > SET > Display > **Backlight Timer**

Sets the Backlight Timer to 5, 10, or 30 seconds.

Depending on the "Backlight" setting, the backlight lights for this set period of time, and then automatically reduces the brightness.

① When "Dim Screen" is set to "OFF," the backlight goes out after this set period of time.

### Brightness (Default: 8)

[MENU] > SET > Display > **Brightness**

Sets the LCD backlight brightness level to between 1 (dim) and 8 (bright).

### Dim Screen (Default: ON)

[MENU] > SET > Display > **Dim Screen**

Selects whether or not to automatically reduce the backlight brightness.

- OFF: The backlight immediately goes out after the set period of time in "Backlight Timer."
- ON: The backlight brightness automatically changes to the "Brightness (Dim)" level after the set period of time in "Backlight Timer," and goes out after the set period of time in "Dim Timer."

#### The image of the Dim Screen function

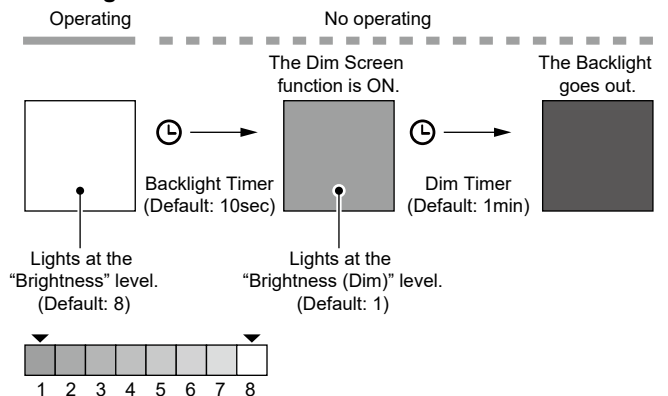

### Dim Timer (Default: 1min)

[MENU] > SET > Display > **Dim Timer**

Sets the Dim Timer to 1, 2, 5, or 10 minutes, or Hold. Depending on the "Dim Screen" setting, the backlight lights at the "Brightness (Dim)" level for this set period of time, and then automatically goes out.

- 1/2/5/10min: The backlight goes out after this set period of time.
- Hold: The backlight does not go out.

### Brightness (Dim) (Default: 1)

[MENU] > SET > Display > **Brightness (Dim)**

Sets the LCD backlight brightness level for the set period of time in "Dim Timer," to between 1 (dim) and 7 (bright).

- ① Set a lower level than "Brightness." If you set a higher level than "Brightness," the Dim Screen function does not work.
- ① You can check the brightness at each level on the "Brightness" screen.

### Background Color (Default: White)

[MENU] > SET > Display > **Background Color**

Sets the display background color to Black or White.

### Contrast (Default: Standard)

[MENU] > SET > Display > **Contrast**

Sets the display contrast to Light, Standard, or Dark.

## Display

### **Busy LED** (Default: ON)

[MENU] > SET > Display > **Busy LED**

Selects whether or not to light the TX/RX indicator while receiving a signal, or the squelch is open. To conserve battery power, turn OFF this function.

- ① The indicator lights red while transmitting, regardless of the setting.
- OFF: The indicator does not light, even if a signal is received.
- ON: The indicator lights green while receiving a signal, or the squelch is open.

### **RX Call Sign** (Default: Normal)

[MENU] > SET > Display > **RX Call Sign**

In the DV mode, selects whether or not to display the call sign and the message of the caller station when a call is received.

- OFF: Does not display the caller station's call sign and message.
- Normal: The caller station's call sign and message automatically scroll once, and then disappear.
- RX Hold: The caller station's call sign and message automatically scroll once, and then the call sign is displayed on the transceiver's display until the signal disappears.
- Hold: The caller station's call sign and message automatically scroll once, and then the call sign is displayed on the transceiver's display until the signal disappears. When the signal disappears, the call sign and the message are each repeatedly displayed for 2 seconds.

- ① When "Normal," "RX Hold," or "Hold" is selected, and if the call sign and name of the caller station is entered in your memory, the name is displayed after displaying the call sign.

### **RX Position Indicator** (Default: ON)

[MENU] > SET > Display > **RX Position Indicator**

Selects whether or not to display the indicator when position data is included in the signal received in the DV mode.

- OFF: No indicator is displayed, even though the position data is included in the received signal.
- ON: The indicator is displayed when the position data is included in the received signal.
- ① When "RX Call Sign" is set to "OFF," the indicator is not displayed, even though position data is included in the received signal.

### **RX Position Display** (Default: ON (Main/Sub))

[MENU] > SET > Display > **RX Position Display**

Selects whether or not to display position data in a dialog when the caller station's position data is included in the signal received in the DV mode.

- OFF: No data is displayed in a dialog.
- ON (Main/Sub):  
When the caller station's position data is included in the signal, its data is displayed in a dialog.
- ON (Main Only):  
When the caller station's position data is included in the signal received in the MAIN band, its data is displayed in a dialog.
- ① The time period to display the dialog depends on the "RX Position Display Timer" setting.

### **RX Position Display Timer** (Default: 10sec)

[MENU] > SET > Display > **RX Position Display Timer**

Sets the RX position data's time period to display in a dialog.

- 5/10/15/30sec: Displays the caller's position for this set period of time.
- Hold: Displays the caller's position until you operate the transceiver.

### **Reply Position Display** (Default: ON)

[MENU] > SET > Display > **Reply Position Display**

Selects whether or not to display the caller's position data when the data is included in the Auto Reply signal.

- OFF: Does not display the caller's position data.
- ON: Automatically displays the caller's position data.

### **RX Picture Indicator** (Default: ON)

[MENU] > SET > Display > **RX Picture Indicator**

Selects whether or not to display the RX Picture Indicator when a picture is included in the received signal.

- OFF: No indicator is displayed, even if a picture is included in the received signal.
- ON: The indicator is displayed when a picture is included in the received signal.
- ① When "RX Call Sign" is set to "OFF," the indicator is not displayed, even if a picture is included in the received signal.

## Display

### DV RX Backlight (Default: ON)

[MENU] > SET > Display > **DV RX Backlight**

Turns the DV RX Backlight function ON or OFF. In the DV mode, this function turns ON the backlight while displaying the calling station's call sign or a received message.

- OFF: Turns OFF the function.
- ON: The backlight automatically lights when displaying the calling station's call sign or a received message. The backlight stays ON while the call sign or message is scrolling.

**NOTE:** When you set this item to "ON," set "Backlight" to "Auto" or "Auto (DC IN:ON)."

### TX Call Sign (Default: Your Call Sign)

[MENU] > SET > Display > **TX Call Sign**

Selects whether or not to display the My or Your call sign while transmitting.

- OFF: Turns OFF the function.
  - Your Call Sign: Displays and scrolls the call sign of the target station.
  - My Call Sign: Displays and scrolls your own call sign.
- ① When "Your Call Sign" is selected, and if the call sign and name of the caller station is entered in your memory, the name is displayed after the call sign, in any DV mode except when using the DR function.

### Scroll Speed (Default: Fast)

[MENU] > SET > Display > **Scroll Speed**

Sets the scrolling speed of the message, call sign, or other text, that are displayed on the screen to "Slow" or "Fast."

### Opening Message (Default: ON)

[MENU] > SET > Display > **Opening Message**

Selects whether or not to display the opening message at power ON.

When you set this item to "ON," Icom logo, MY call sign, and the model are displayed.

### Voltage (Power ON) (Default: ON)

[MENU] > SET > Display > **Voltage (Power ON)**

Selects whether or not to display the voltage of the battery or external DC power source at power ON.

**NOTE:** When the external DC power source voltage is above 15.6V, "HI Voltage" is displayed. In that case, immediately disconnect the DC power source.

### Single Band Display (Default: Date)

[MENU] > SET > Display > **Single Band Display**

Selects to display the date or GPS information at the bottom of the Single band display.

- Date: Displays the date.
- GPS Information: Displays the GPS information.

### Latitude/Longitude (Default: ddd° mm.mm')

[MENU] > SET > Display > Display Unit > **Latitude/Longitude**

Selects the format to display the position data.

### Altitude/Distance (Default: ft/mi)

[MENU] > SET > Display > Display Unit > **Altitude/Distance**

Selects the format to display the distance and elevation.

- ① The default value may differ, depending on the transceiver version.

### Speed (Default: mph)

[MENU] > SET > Display > Display Unit > **Speed**

Selects the format to display the speed.

- ① The default value may differ, depending on the transceiver version.

### Temperature (Default: °F)

[MENU] > SET > Display > Display Unit > **Temperature**

Selects the format to display the temperature.

- ① The default value may differ, depending on the transceiver version.

### Barometric (Default: inHg)

[MENU] > SET > Display > Display Unit > **Barometric**

Selects the format to display the barometric pressure.

- ① The default value may differ, depending on the transceiver version.

## Display

### Rainfall (Default: inch)

[MENU] > SET > Display > Display Unit > **Rainfall**

Selects the format to display the amount of rainfall.

- ① The default value may differ, depending on the transceiver version.

### Wind Speed (Default: mph)

[MENU] > SET > Display > Display Unit > **Wind Speed**

Selects the format to display the wind speed.

- ① The default value may differ, depending on the transceiver version.

### Display Language (Default: English)

[MENU] > SET > Display > **Display Language**

Sets the screen display language to English or Japanese.

- ① This item is displayed only when "System Language" is set to "Japanese."

### System Language (Default: English)

[MENU] > SET > Display > **System Language**

Sets the system language of the transceiver.

- English: The system language of the transceiver is English. Only alphabetical characters (A to Z, a to z, 0 to 9) and symbols (! " # \$ % & ' ( ) \* + , - . / : ; < = > ? @ [ \ ] ^ \_ { | } ~) can be displayed. If Japanese characters (Kanji, Hiragana, and Katakana) are included, the display shows "=" or "\_" instead of that character. In that case, you can only delete "=" or "\_" in the transceiver's edit mode.
- Japanese: The system language of the transceiver is Japanese. Kanji, Hiragana, and Katakana characters, and the 2-bytes symbols can be displayed. To display such characters in the DR screen or Menu mode, set "Display Language" to "Japanese."

- ① When this item is set to "English," "Display Language" is not displayed.

When you set the system language of the transceiver to Japanese, the transceiver has the capability to display both English and Japanese characters. HOWEVER, if you select Japanese, all menu items throughout the transceiver system will be displayed in only Japanese characters. There will be no English item names. Unless you are fluent in reading Japanese characters, use this feature with extreme caution.

If you have change the transceiver's language to Japanese and do not understand the menu system in the new setting, you will have to change the language back to English by doing a partial reset of the transceiver CPU. A partial reset will not clear your call sign databases.

To do a partial reset of the CPU, do the following steps:

1. Push [MENU].
2. Select "SET."



3. Select the item (with the "etc" icon) shown below.



4. Select the bottom item shown below.

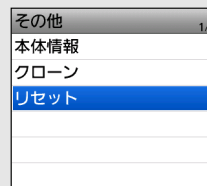

5. Select the upper item shown below.

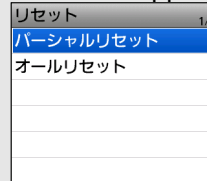

- ① **DO NOT** select the lower item. The lower item is for the All reset function, and the All reset clears all entries and returns all settings to their factory defaults.

6. Select the upper option.

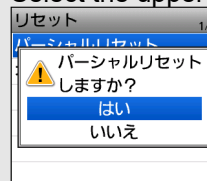

- When the partial reset is completed, "PARTIAL RESET" is displayed, then the display automatically returns to the default screen.

## Sounds

### Volume Select (Default: All)

[MENU] > SET > Sounds > **Volume Select**

Select whether or not to adjust the audio output level independently, according to the operating status.

- All: The audio output level for the FM Radio, A band (VFO A), and B band (VFO B) are adjusted at the same time.
- FM Radio Separate: The audio output level for the FM Radio is independently adjusted. The audio output level for A band (VFO A) and B band (VFO B) are adjusted at the same time.
- Separate: The audio output level for the FM Radio, A band (VFO A), and B band (VFO B) are independently adjusted.

**NOTE:** When an EMR signal is received, the audio output level for A band and/or B band may be set to the selected level in “EMR AF Level,” depending on this setting.

① The audio output level for the FM Radio is not changed, because the EMR function is for the DV mode operation.

#### When “All” or “FM Radio Separate” is selected:

The audio output level for A band and B band is set to the selected level in “EMR AF Level.”

#### When “Separate” is selected:

Either the audio output level for A band or B band that the signal is received on, is set to the selected level in “EMR AF Level.”

### FM Radio Level (Default: 0)

[MENU] > SET > Sounds > **FM Radio Level**

Sets the initial audio output level difference between the FM Radio and the A and B bands when “Volume Select” is set to “All.”

- +5 ~ +1: The FM Radio audio output level is higher than the VFO mode audio.
- 0: The FM Radio audio output level is the same as the VFO mode audio.
- -5 ~ -1: The FM Radio audio output level is lower than the VFO mode audio.

### Earphone Mode (Default: OFF)

[MENU] > SET > Sounds > **Earphone Mode**

Turns the earphone mode ON or OFF.

While in the earphone mode, the audio volume level is automatically adjusted to the comfortable level when the optional earphone is connected to the [MIC/SP] jack.

### Beep Level (Default: 3)

[MENU] > SET > Sounds > **Beep Level**

Sets the beep output level to 0 (OFF) or 1 (minimum) ~ 9 (maximum).

### Beep/Vol Level Link (Default: OFF)

[MENU] > SET > Sounds > **Beep/Vol Level Link**

Selects whether or not the beep output level can be adjusted by rotating [VOL].

- OFF: The output level is fixed to the level set in “Beep Level.”
- ON: The output level can be adjusted by rotating [VOL].

### Key-Touch Beep (Default: ON)

[MENU] > SET > Sounds > **Key-Touch Beep**

Turns the confirmation beep ON or OFF.

- OFF: No beep sounds.
- ON: A beep sounds when you push a key.

### Home CH Beep (Default: ON)

[MENU] > SET > Sounds > **Home CH Beep**

Turns the Home CH Beep ON or OFF.

- OFF: No beep sounds.
  - ON: A beep sounds when you select the Home Channel.
- ① In the VFO or Memory mode, when the Home Channel frequency or the Home Channel Memory is selected, the Home CH Beep sounds.
- ② In the DR screen, when the Home Channel Access repeater is set in FROM, the Home CH Beep sounds.

### Band Edge Beep (Default: OFF)

[MENU] > SET > Sounds > **Band Edge Beep**

Turns the Band Edge Beep ON or OFF.

- OFF: No beep sounds.
- ON: A beep sounds when you tune out of, or back into the AIR, VHF, and UHF band’s frequency range.

### Scan Stop Beep (Default: OFF)

[MENU] > SET > Sounds > **Scan Stop Beep**

Turns the Scan Stop Beep ON or OFF.

- OFF: No beep sounds.
- ON: A beep sounds when a scan stops by receiving a signal.

## Sounds

### Standby Beep (Default: ON (to me:Alarm/High Tone))

[MENU] > SET > Sounds > **Standby Beep**

Turns the Standby Beep function ON or OFF. This function sounds a beep after a received signal disappears, in the DV mode.

- OFF: Does not sound a beep after a received signal disappears.
- ON: Sounds a beep after a received signal disappears.
- ON (to me:High Tone): Sounds a high pitched beep when a received signal that is addressed to your call sign (MY) disappears. When any other received signal disappears, a regular beep sounds.
- ON (to me:Alarm/High Tone): Sounds alarm (PiRoPiRoPiRo) when a received signal that is addressed to your call sign (MY) disappears. When any other received signal disappears, a regular beep sounds.

① The standby beep sounds even when “Key-Touch Beep” is set to “OFF.”

① The standby beep output level depends on the “Beep Level” setting.

### Sub Band Mute (Default: OFF)

[MENU] > SET > Sounds > **Sub Band Mute**

Selects whether or not to mute the SUB band audio signal while receiving on the MAIN band, and/or sound a beep when a signal disappears on the SUB band.

- OFF: Turns OFF the function.
- Mute: While receiving on the MAIN band, the SUB band audio signal is muted.
- Beep: When a signal disappears on the SUB band, a beep sounds.
- Mute & Beep: While receiving on the MAIN band, the SUB band audio signal is muted. When a signal disappears on the SUB band, a beep sounds.

① When you set this item to “Beep” or “Mute & Beep,” a beep sounds, even if no signal is received on the MAIN band.

## Time Set

### DATE

[MENU] > SET > Time Set > Date/Time > **DATE**

Manually set the date to between 2020/01/01 and 2099/12/31.

① The day of the week is automatically set.

### TIME

[MENU] > SET > Time Set > Date/Time > **TIME**

Manually set the time that is displayed at the top of the screen. The time is displayed in the 24 hour format. When “GPS Time Correct” is set to “Auto,” the GPS receiver automatically sets the time by calculating the received Universal Time of Coordinated (UTC) time and “UTC Offset.”

### GPS Time Correct (Default: Auto)

[MENU] > SET > Time Set > **GPS Time Correct**

Selects whether or not the time data is automatically corrected by a received GPS sentence.

- OFF: Does not correct the time.
- Auto: Automatically corrects the time by calculating the received UTC time and the “UTC Offset” setting.

### UTC Offset (Default: ±0:00)

[MENU] > SET > Time Set > **UTC Offset**

Sets the UTC offset time to between -14:00 and +14:00.

### Auto Power OFF (Default: OFF)

[MENU] > SET > Time Set > **Auto Power OFF**

Selects whether or not to automatically turn OFF the transceiver after inactivity for this set period of time.

- ① “AUTO POWER OFF” is displayed and beeps sound 5 seconds before turning OFF the transceiver. If you operate the transceiver during this period of time, the Auto Power OFF timer is reset.
- OFF: Does not turn OFF the transceiver.
  - 30/60/90/120min: Turns OFF the transceiver after inactivity for this set period of time.

## SD Card

### Load Setting

[MENU] > SET > SD Card > **Load Setting**

Selects the saved data file to load.

### Save Setting

[MENU] > SET > SD Card > **Save Setting**

Saves the setting data onto a microSD card.

### Save Form (Default: Now Ver)

[MENU] > SET > SD Card > **Save Form**

Selects the format to save the settings to a microSD card.

- Now Ver: Saves the settings in the current version format.
- Old Ver (x.xx - x.xx): Saves the settings in an older version format indicated in the parenthesis (x.xx = version).

- ① If you select "Old Ver (x.xx - x.xx)," a function that is added when the transceiver's firmware format is updated will not be saved.
- ① You cannot load a setting file that is saved in the current version format to an earlier firmware version.

### Import

[MENU] > SET > SD Card > Import/Export > **Import**

Import the Memory channel contents, Radio memory contents, UR call sign, repeater list, or GPS memory data in the CSV format file.

### Export

[MENU] > SET > SD Card > Import/Export > **Export**

Export the Memory channel contents, Radio memory contents, UR call sign, repeater list, or GPS memory data in the CSV format file.

### Separator/Decimal (Default: Sep[,] Dec[.] )

[MENU] > SET > SD Card > Import/Export > CSV Format > **Separator/Decimal**

Selects the separator and the decimal character for the CSV format.

- ① The default value may differ, depending on the transceiver version.
- Sep [,] Dec [.]: Separator is "," and Decimal is "."
- Sep [;] Dec [.] : Separator is ";" and Decimal is "."
- Sep [;] Dec [,] : Separator is ";" and Decimal is ","

### Date

(Default: mm/dd/yyyy)

[MENU] > SET > SD Card > Import/Export > CSV Format > **Date**

Selects the date format between "yyyy/mm/dd," "mm/dd/yyyy," and "dd/mm/yyyy."

(y: year, m: month, d: day)

- ① The default value may differ, depending on the transceiver version.

### Opening Picture

[MENU] > SET > SD Card > **Opening Picture**

Selects the picture that is displayed at power ON.

- ① See page 15-15 for details.

### SD Card Info

[MENU] > SET > SD Card > **SD Card Info**

Displays the microSD card capacity and the time remaining for voice recording.

### Screen Capture View

[MENU] > SET > SD Card > **Screen Capture View**

Displays the selected screen capture.

### TX/RX Picture View

[MENU] > SET > SD Card > **TX/RX Picture View**

Displays the pictures that are saved on the microSD card.

- ① The transceiver cannot display the picture while transmitting picture data.
- ① The transceiver can display up to 500 pictures.

### Firmware Update

[MENU] > SET > SD Card > **Firmware Update**

Displays the Firmware Update mode.

### Format

[MENU] > SET > SD Card > **Format**

Formats the microSD card.

If you use a brand new microSD card, be sure to format it in the transceiver.

### Unmount

[MENU] > SET > SD Card > **Unmount**

Unmounts the microSD card.

Before you remove a card when the transceiver is ON, be sure to electrically unmount it. Otherwise, the data may be corrupted or deleted.

## Bluetooth Set

### Bluetooth (Default: OFF)

[MENU] > SET > Bluetooth Set > **Bluetooth**

Turns the Bluetooth function ON or OFF.

### Auto Connect (Default: ON)

[MENU] > SET > Bluetooth Set > **Auto Connect**

Selects whether or not to automatically connect to the paired Bluetooth device when its power is turned ON.

- OFF: Does not connect to the paired device.
- ON: Automatically connects to the last connected device.

### Pairing/Connect

[MENU] > SET > Bluetooth Set > **Pairing/Connect**

Searches for the Bluetooth device to connect, or display the paired Bluetooth devices in the list.

① See page 13-3 for details.

### <<Pairing Reception>>

[MENU] > SET > Bluetooth Set > **<<Pairing Reception>>**

Enters the pairing reception mode.

① See page 17-7 for details.

### AF Output (Default: Headset Only)

[MENU] > SET > Bluetooth Set > Headset Set > **AF Output**

Selects the AF Output device when a Bluetooth headset is connected.

- Headset Only: Outputs audio to only the connected Bluetooth headset.
- Headset & Speaker: Outputs audio to both the connected Bluetooth headset and the transceiver's speaker.

### Headset Function Select (Default: Normal)

[MENU] > SET > Bluetooth Set > Headset Set > **Headset Function Select**

Selects the PTT and microphone combination when both the Bluetooth headset and the transceiver microphone are used.

- Normal: Transmits the audio from the Bluetooth headset, or the transceiver microphone, whichever [PTT] is pushed.
- Microphone: Transmits the audio from the Bluetooth headset. Transmission is enabled by pushing either the [PTT] on the Bluetooth headset, or the transceiver microphone. The transceiver microphone is only used for the PTT control.
- PTT: Transmits the audio from the transceiver microphone. Transmission is enabled by pushing either the [PTT] on the Bluetooth headset, or the transceiver microphone. The Bluetooth headset is only used for the PTT control.

① The Bluetooth headset operation for each option is listed below.

| Option     | TX control | TX audio  |
|------------|------------|---|
| Normal     | Enabled    | Enabled   |
| Microphone | Enabled    | Enabled   |
| PTT        | Enabled    | Disabled<br>(Audio from the microphone is transmitted.) |

### Auto Disconnect (Default: OFF)

[MENU] > SET > Bluetooth Set > Headset Set > **Auto Disconnect**

Sets the Disconnect Timer between 0 and 10 seconds, or OFF.

If there is no audio output from the Bluetooth headset, and there is no key operation for this set period of time, the Synchronous Connection-Oriented (SCO) link\* is automatically disconnected.

① The SCO link is connected when the signal is received, a beep sounds, or there is a key operation.

\* A Bluetooth link for voice communication

## Bluetooth Set

### RX Priority Setting (LE Device)

(Default: MAIN Band)

[MENU] > SET > Bluetooth Set > Headset Set > **RX Priority Setting (LE Device)**

Selects the communication priority for the DV Fast Data and receive audio, when connecting an iOS device (Bluetooth LE (Low Energy)) and a Bluetooth headset. The Bluetooth LE communication cannot be simultaneously used for both DV Fast Data and Headset audio.

① When connecting to an SPP (Serial Port Profile) device such as a data device or PC, the Bluetooth device functions according to the "Serialport Function" (p. 12-34) setting.

- DV Fast Data: Received audio is not output from the headset, regardless of the band (MAIN or SUB).
- RX Audio: DV Fast Data is not transferred during the received audio is output from the headset.
- MAIN Band: The audio received on the SUB band is not output from the headset when a DV Fast Data is received on the MAIN band.  
DV Fast Data that is received on the SUB band is not transferred while a signal is received on the MAIN band.

### VOX

(Default: OFF)

[MENU] > SET > Bluetooth Set > Headset Set > **VOX > VOX**

Turns the Voice Operated Transmission (VOX) function ON or OFF.

The VOX function starts transmission without pushing [PTT] when you speak into the microphone, and then, automatically returns to receive when you stop speaking.

① To use the VOX function, the optional Bluetooth headset is required.

- OFF: Turns OFF the function.
- ON: Starts transmission without pushing [PTT] when you speak into the microphone. Then automatically returns to receive when you stop speaking.

### VOX Level

(Default: 5)

[MENU] > SET > Bluetooth Set > Headset Set > **VOX > VOX Level**

Sets the VOX gain level to between 1 and 10, or OFF. Higher values make the VOX function more sensitive to your voice.

- OFF: Turns OFF the VOX function.
- 1 ~ 10: 1 (The minimum sensitivity)  
10 (The maximum sensitivity)

### VOX Delay

(Default: 0.5sec)

[MENU] > SET > Bluetooth Set > Headset Set > **VOX > VOX Delay**

Sets the VOX Delay time to 0.5, 1.0, 1.5, 2.0, 2.5 or 3.0 seconds. The VOX Delay is the amount of time the transmitter stays ON after you stop speaking, before the VOX switches to receive.

### VOX Time-Out Timer

(Default: 3min)

[MENU] > SET > Bluetooth Set > Headset Set > **VOX > VOX Time-Out Timer**

Sets the VOX Time-Out Timer to prevent an accidental prolonged transmission. To disable the function, set to "OFF."

- OFF: Turns OFF the function.
- 1, 2, 3, 4, 5, 10, or 15min:  
If a continuous transmission exceeds the set period of time, the transmission is cut off.

# 12 SET MODE

## Bluetooth Set

### Power Save (Default: OFF)

[MENU] > SET > Bluetooth Set > Headset Set > Icom Headset > **Power Save**

Selects whether or not to operate with the Power Save mode while the optional VS-3 headset is connected.

- ① When a headset (user supplied) or a data device is connected, the Power Save mode is automatically turned OFF, regardless of this setting.
- OFF: Turns OFF the function.
- ON: The Power Save mode is enabled when no communication or operation is performed for 120 seconds.

### One-Touch PTT (Default: OFF)

[MENU] > SET > Bluetooth Set > Headset Set > Icom Headset > **One-Touch PTT**

Sets the One-Touch PTT function when the optional VS-3 headset is connected.

This function enables you to transmit without continuously holding down [PTT].

- ① When a headset (user supplied) is connected, this function is automatically turned ON, regardless of this setting.
- OFF: Transmits while holding down [PTT].
- ON: Pushing [PTT] toggles between transmit and receive.

### PTT Beep (Default: OFF)

[MENU] > SET > Bluetooth Set > Headset Set > Icom Headset > **PTT Beep**

Sets the beep sound when you push [PTT] on the optional VS-3 headset.

- OFF: No beep sounds.
- ON: A beep sounds.

### Custom Key Beep (Default: OFF)

[MENU] > SET > Bluetooth Set > Headset Set > Icom Headset > **Custom Key Beep**

Sets the beep sound when you push the Custom Key ([PLAY]/[FWD]/[RWD]) on the optional VS-3 headset.

- OFF: No beep sounds.
- ON: A beep sounds.

### Custom Key (Default: [PLAY]: --- [FWD]: UP [RWD]: DOWN)

[MENU] > SET > Bluetooth Set > Headset Set > Icom Headset > **Custom Key**

Assigns the functions to the Custom Key ([PLAY]/[FWD]/[RWD]) on the optional VS-3 headset.

- ① See page 12-35 about the functions.

### Serialport Function (Default: CI-V (Echo Back OFF))

[MENU] > SET > Bluetooth Set > Data Device Set > **Serialport Function**

Sets the serial port function for the Bluetooth SPP (Serial Port Profile) connection to a data device, PC, and so on.

- CI-V (Echo Back OFF):
  - Transmits or receives a CI-V command.
  - Does not send back the serial data received from the SPP connection.
- CI-V (Echo Back ON):
  - Transmits or receives a CI-V command.
  - Sends back the serial data received from the SPP connection.
- DV Data: Transmits or receives data in the DV mode.
  - Does not input the cloning or weather data entries, or output the GPS data.

### Bluetooth Device Information

[MENU] > SET > Bluetooth Set > **Bluetooth Device Information**

Displays the Bluetooth device information.

### Initialize Bluetooth Device

[MENU] > SET > Bluetooth Set > **Initialize Bluetooth Device**

Initializes the installed Bluetooth unit.

# 12 SET MODE

## Bluetooth Set

### The assignable key functions

| Function       | Descriptions   |
|----------------|--|
| ---            | No function  |
| UP             | Push to increase the frequency, Memory channel, repeater, or station call sign.  |
| DOWN           | Push to decrease the frequency, Memory channel, repeater, or station call sign.  |
| VOL UP         | Push to increase the volume level.   |
| VOL DOWN       | Push to decrease the volume level.   |
| SQL UP         | Push to increase the squelch level.  |
| SQL DOWN       | Push to decrease the squelch level.  |
| Monitor (Push) | Hold down to open the squelch. Release to close the squelch.   |
| Monitor (Hold) | Push to open or close the squelch.   |
| CALL           | Push to select a Call Channel mode.  |
| MR (00-00 CH)  | In the Memory mode, push to select Memory channel 00-00.   |
| MR (00-01 CH)  | In the Memory mode, push to select Memory channel 00-01.   |
| VFO/MR         | Push to select the VFO mode and the Memory mode.   |
| DR             | Push to turn the DR function ON or OFF.  |
| FROM/TO (DR)   | In the DR screen, push to select "FROM" and "TO."  |
| Home CH        | Push to directly select the Home Channel that is set to the selected mode (VFO/Memory) or DR screen.<br>① While in the Call Channel mode, or when no Home CH is set, an error beep sounds.   |
| BAND           | Push to select an operating band.  |
| SCAN           | Push to start the previously selected scan. While scanning, push to stop the scan.   |
| Temporary Skip | Push to set the frequency to be skipped while scanning.<br>The selected frequencies are temporarily skipped for faster scanning.   |
| RX>CS          | Hold down for 1 second to set the last calling station's call sign to "TO" (destination).<br>① If "[RX→CS] Key" is set to "RX > CS List," the received call sign is not captured. The RX History list is displayed instead.<br>② To select the call sign in the RX History using the optional remote control speaker microphone, assign "UP"/"DOWN."   |
| SPEECH         | <ul style="list-style-type: none"> <li>In the VFO, Memory, or Call Channel mode, push to announce the frequency and operating mode.</li> <li>In the DR screen, push to announce the call sign.</li> </ul> ① If the Simplex mode is selected, the frequency is announced.<br>If the FM repeater is selected, the frequency and operating mode, or the call sign and operating mode are announced. |
| MAIN/DUAL      | <ul style="list-style-type: none"> <li>Push to set the A or B band as the MAIN band.</li> <li>Hold down for 1 second to turn the Dualwatch function ON or OFF.</li> </ul>  |
| MODE           | Push to select the operating mode.   |
| LOW            | Push to select the transmit output power.  |
| DUP            | Push to turn the Duplex mode ON or OFF, and the shift direction to DUP+ or DUP-.   |
| TONE/D.SQL     | <ul style="list-style-type: none"> <li>In the FM/FM-N mode, push to select the tone type.</li> <li>In the DV mode, push to select the digital squelch type.</li> </ul>   |
| MW             | In the VFO mode or on the DR screen, hold down for 1 second to enter the Memory channel contents to a blank channel.   |
| REC            | <ul style="list-style-type: none"> <li>Push to start recording.</li> <li>While recording, hold down for 1 second to stop recording.</li> </ul>   |
| Voice TX       | <ul style="list-style-type: none"> <li>Push to transmit the voice audio recorded on the microSD card once.</li> <li>Hold down for 1 second to repeatedly transmit the voice audio.</li> </ul>  |
| T-CALL         | Push to transmit a 1750 Hz tone.   |

## Others

### Voltage

---

[MENU] > SET > Others > Information > **Voltage**

Displays the voltage of the battery pack and external power source.

- ① When you attach the Li-ion battery pack, the charge status of the battery pack and the battery voltage are displayed.
- ① When you attach the optional battery case, the battery case's terminal voltage is displayed.

### Version

---

[MENU] > SET > Others > Information > **Version**

Displays the transceiver firmware's version number.

### Clone Mode

---

[MENU] > SET > Others > Clone > **Clone Mode**

Enters the clone mode to read or write the CS-52 data from or to the PC.

- ① Restart the transceiver to cancel the clone mode.

### Partial Reset

---

[MENU] > SET > Others > Reset > **Partial Reset**

Resets operating settings to their default values (VFO frequency, VFO settings, menu contents).

- ① See page 15-18 for details.

### All Reset

---

[MENU] > SET > Others > Reset > **All Reset**

Clears all data and returns all settings to their factory defaults.

Memory channel contents, Repeater list, and so on will all be cleared, so you will need to rewrite your operating settings.

- ① See page 15-18 for details.

# Section 13 Bluetooth® OPERATION

---

|   |      |
|---|------|
| Bluetooth® operations.....                      | 13-2 |
| Turning ON the Bluetooth® function .....        | 13-2 |
| Connecting to a Bluetooth® headset.....         | 13-3 |
| Headset Settings .....                          | 13-4 |
| ◇ AF Output .....                               | 13-4 |
| ◇ Headset Function Select .....                 | 13-4 |
| ◇ Auto Disconnect .....                         | 13-5 |
| ◇ RX Priority Setting (LE Device) .....         | 13-5 |
| ◇ VOX function .....                            | 13-5 |
| ◇ About the Icom headset (VS-3) .....           | 13-6 |
| Editing the installed Bluetooth® unit.....      | 13-7 |
| Initializing the installed Bluetooth® unit..... | 13-7 |
| The maximum number of paired devices .....      | 13-7 |

## Bluetooth® operations

You can connect Bluetooth devices to the transceiver using the Bluetooth function.

① See the Basic manual to pair, disconnect, or delete devices.

### Icom Headset

When you connect the VS-3 Bluetooth® headset to the transceiver, you can wirelessly transmit and receive it. The VS-3 has a [PTT] switch, so you can transmit in the same way as using the transceiver's [PTT] switch. The VOX function can also be used to select transmit and receive by using your voice through the headset to switch between TX and RX.

You can assign a function to the keys on the side panel of the VS-3 to remotely operate the transceiver.

### Android™/iOS device

When you connect a mobile device to the transceiver through Bluetooth and using the application, you can use the extended D-STAR functions such as data transmission and image transmission.

① See page 17-5 for the applications and how to pair the transceiver with a mobile device.

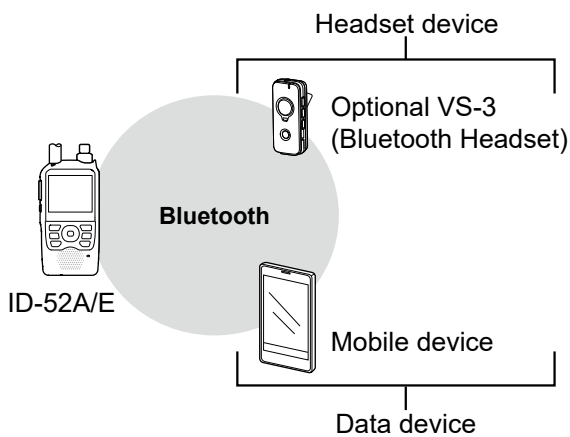

## Turning ON the Bluetooth® function

[MENU] > SET > Bluetooth Set > **Bluetooth**

1. Push [MENU].
2. Select "Bluetooth Set" in the "SET" menu.
3. Select "Bluetooth."

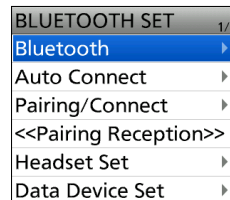

4. Select "ON."

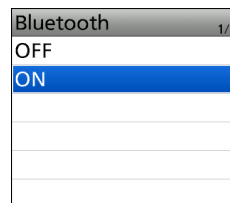

① To exit the MENU screen, push [MENU].

**IMPORTANT:** The Bluetooth communication range may vary, depending on the environment in which the device operates. Microwave ovens or Wireless LAN may cause interference. In that case, stop using those devices or increase the space between the Bluetooth device and the other devices. All Bluetooth devices have a range of use. If the communication is unstable, use the device within the range.

## Connecting to a Bluetooth® headset

You can connect an optional Bluetooth headset to the transceiver.

### Step 1. Selecting the pairing mode of the headset.

See the instruction manual of the headset to select the pairing mode.

### Step 2. Searching for the headset (Transceiver)

[MENU] > SET > Bluetooth Set > Pairing/Connect

1. Push [MENU].
2. Select "Bluetooth Set" in the "SET" menu.
3. Select "Pairing/Connect."

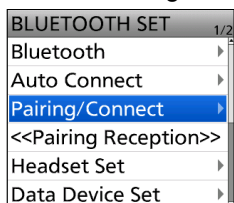

4. Select "Device Search."

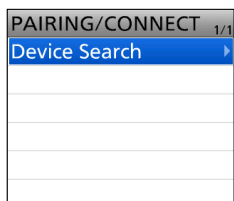

5. Select "Search Headset."

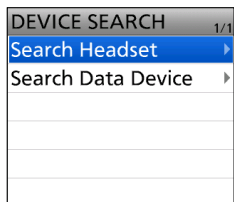

- Displays the usable headsets in the pairing list.

6. Select a headset to pair.

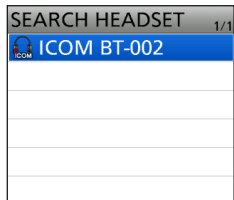

- The confirmation dialog is displayed.

7. Select "YES."

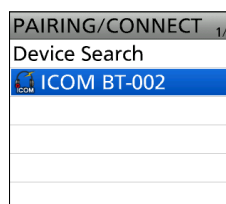
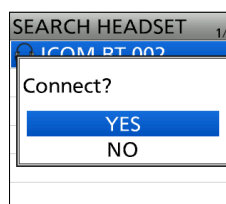

- After connecting to the headset,  is displayed in the pairing list.

8. To exit the MENU screen, push [MENU].

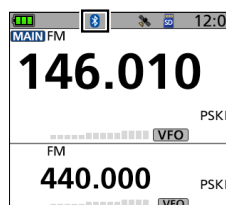

- ① While connected to a Bluetooth device, the Bluetooth icon is displayed on the Standby screen.
- ① When "AF Output" is set to "Headset Only" and the Bluetooth connection is accidentally disconnected, a dialog is displayed to select whether or not to output the audio from the transceiver's speaker. (p. 13-4)

## Headset Settings

These are settings when using a Bluetooth headset.

1. Push [MENU].
2. Select “Bluetooth Set” in the “SET” menu.
3. Select “Headset Set.”

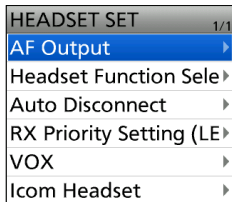
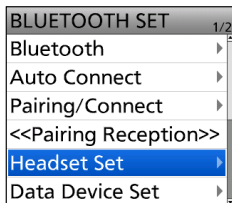

### ◆ AF Output

[MENU] > SET > Bluetooth Set > Headset Set > AF Output

You can select the AF Output device.

If “AF Output” is set to “Headset & Speaker,” you can hear audio from both a connected Bluetooth headset and the transceiver’s speaker.

① See page 12-32 for details.

**TIP:** When “AF Output” is set to “Headset Only,” the following dialog is displayed if the Bluetooth connection is accidentally disconnected.

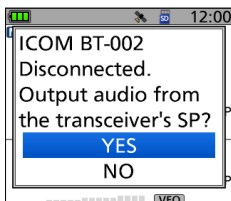

- YES: The audio is output from the transceiver’s speaker.
- NO: The transceiver’s volume level is automatically set to 0, and the audio is not output from the transceiver’s speaker.

### ◆ Headset Function Select

You can select the PTT and microphone combination when either a Bluetooth headset or the transceiver microphone are used.

① See page 12-32 for details.

[MENU] > SET > Bluetooth Set > Headset Set > Headset Function Select

- **Normal:**  
Transmitting the voice from the Bluetooth headset while pressing [PTT] or the internal microphone’s voice.
- **Microphone:**  
Using the Bluetooth headset as a microphone.  
① The audio from the internal microphone cannot be transmitted.  
① You can also transmit by pressing the Bluetooth headset’s [PTT].
- **PTT:**  
Using the Bluetooth headset as a PTT switch.  
① The audio from the internal microphone is transmitted. The audio from the Bluetooth headset cannot be transmitted.  
① You can also transmit by pressing the transceiver’s [PTT].

The operation of the Bluetooth headset for each setting is shown in the table below.

| Setting    | Transmit operation | Audio input               |
|------------|--------------------|---------------------------|
| Normal     | ✓                  | ✓                         |
| Microphone | ✓                  | ✓                         |
| PTT        | ✓                  | (Use internal microphone) |

## Headset Settings

### ◇ Auto Disconnect

[MENU] > SET > Bluetooth Set > Headset Set > **Auto Disconnect**

You can set the disconnect timer between 0 and 10 seconds or OFF.

If there is no audio signal to the Bluetooth headset, or no operation is performed for a set period of time, the receiver automatically disconnects the Synchronous Connection-Oriented (SCO) link.

- ① When a signal is received, or an operation is performed while the SCO link is disconnected, the receiver will automatically reconnect the SCO link again.
- ① See page 12-32 for details.

### ◇ RX Priority Setting (LE Device)

[MENU] > SET > Bluetooth Set > Headset Set > **RX Priority Setting (LE Device)**

You can select the communication priority for the DV Fast Data and receive audio, when connecting an iOS device (Bluetooth LE (Low Energy)) and a Bluetooth headset.

The Bluetooth LE communication cannot be simultaneously used for both DV Fast Data and Headset audio.

- ① When connecting to a SPP (Serial Port Profile) device such as data device or PC, the Bluetooth device functions according to the "Serialport Function" (p. 12-34) setting.
- ① See page 12-33 for details.

### ◇ VOX function

The Voice Operated eXchange (VOX) function toggles the transceiver between transmit and receive by your voice. This function provides hands-free operation. You can use the VOX function with the optional VS-3 or a third party's Bluetooth headset.

Depending on the headset, the VOX function may be disabled because of the differences in microphones.

#### NOTE:

- If the transceiver does not connect to a Bluetooth headset, you cannot use the VOX function through Bluetooth, even if "VOX" is set to ON.  
**BE SURE** to check the Bluetooth connection between the transceiver and the headset before using the VOX function.
- This setting is used for when using the Bluetooth microphone.  
See page 15-10 for using the external microphone.

- ① See page 12-33 for details on the setting items and their options.

[MENU] > SET > Bluetooth Set > Headset Set > **VOX**

#### VOX screen

You can turn the VOX function ON or OFF.

#### VOX Level screen

You can set the VOX gain level. Higher values make the VOX function more sensitive to your voice.

#### VOX Delay screen

You can set the VOX Delay. The VOX Delay is the amount of time the transmitter stays ON after you stop speaking, before the VOX switches to receive.

#### VOX Time-Out Timer screen

You can set the VOX Time-Out Timer to prevent an accidental prolonged transmission. To disable the function, set to "OFF."

## Headset Settings

### ◇ About the Icom headset (VS-3)

You can set the detailed settings of the optional VS-3 Bluetooth® HEADSET.

Also, you can assign a key function to [PLAY], [FWD], and [RWD] on the “Custom Key” screen.

① See page 12-34 for details on the setting items and their options.

[MENU] > SET > Bluetooth Set > Headset Set > Icom Headset

#### Power Save screen

The Power Save function temporarily disconnects the Bluetooth connection if no communication or operation is performed for 120 seconds.

The Power Save function is disabled when the VOX function is ON.

#### One-Touch PTT screen

The One-Touch PTT function enables you to push [PTT] to transmit, and then push again to return to receive.

#### PTT Beep screen

You can set a beep to sound when you push [PTT] on the VS-3.

#### Custom Key Beep screen

You can set a beep to sound when you push [PLAY], [FWD], or [RWD] on the VS-3.

#### Custom key screen

You can assign a key function to [PLAY], [FWD], and [RWD] on the VS-3.

Optional VS-3 Bluetooth® headset

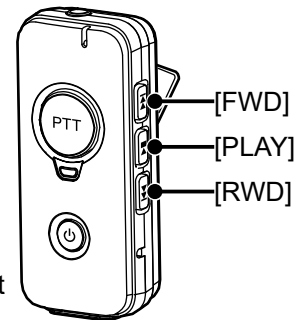

## Editing the installed Bluetooth® unit name

You can edit the transceiver Bluetooth unit's name.

① After initializing the unit, the edited name remains.

[MENU] > SET > Bluetooth Set > Bluetooth Device Information

1. Push [MENU].
2. Select "Bluetooth Set" in the "SET" menu.
3. Select "Bluetooth Device Information."

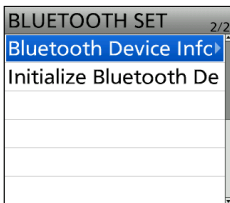

4. Push [QUICK].
5. Select "Edit Name."

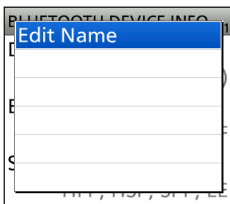

6. Enter a name of up to 9 characters\*, and then push [ENT]. (Example: ICOM BT(ID-52)A)  
\*After "ICOM BT."

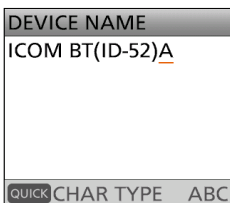
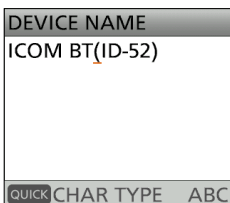

① To exit the MENU screen, push [MENU].

## Initializing the installed Bluetooth® unit

You can initialize the transceiver's Bluetooth unit.

You should initialize the unit if you have trouble during Bluetooth operation.

① After initializing the unit, the pairing/connect list is deleted, but the Bluetooth settings and the unit name remain. The Bluetooth settings return to their factory defaults only when you do a Partial Reset or All Reset. (p. 15-18)

[MENU] > SET > Bluetooth Set > Initialize Bluetooth Device

1. Push [MENU].
2. Select "Bluetooth Set" in the "SET" menu.
3. Select "Initialize Bluetooth Device."

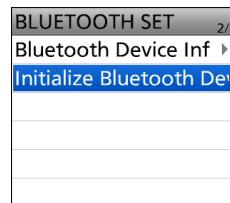

4. Select "YES."

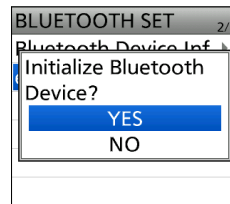

• The transceiver will automatically restart.

## The maximum number of paired devices

You can pair 2 types of Bluetooth devices: a Headset and a Data device.

### Number of maximum pairing devices

- Up to 5 Bluetooth headset and data devices such as Android device can be paired. (Headset 1~4, Data device 1~4)
- Up to 2 iOS devices (Bluetooth LE) can be paired.

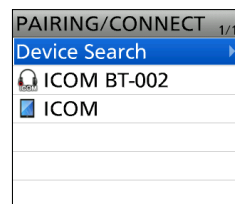

Displays the paired Bluetooth device.

# Section 14 SHARE PICTURES FUNCTION

---

**NOTE:** See the Basic manual Section 6 for details on how to insert or remove a microSD card and precautions.

|   |      |
|---|------|
| About the Share Pictures function .....                       | 14-2 |
| Using the Picture screen .....                                | 14-3 |
| Preparing a TX picture.....                                   | 14-4 |
| ◇ Transfer from the mobile device through Bluetooth.....      | 14-4 |
| ◇ Save on the microSD card using the PC or mobile device..... | 14-4 |
| Sending the picture.....                                      | 14-5 |
| ◇ Moving the TX block marker.....                             | 14-6 |
| ◇ TX PICTURE SET .....  | 14-6 |
| Viewing the pictures .....                                    | 14-7 |
| ◇ Viewing the RX Picture History.....                         | 14-7 |
| ◇ Viewing the TX Picture History .....                        | 14-7 |
| ◇ Viewing the pictures in the "Picture" folder.....           | 14-8 |

## About the Share Pictures function

With this function, you can send a picture that is saved on a microSD card, and view a received picture.

### ① Information

- You must insert a microSD card into the transceiver.
- To use this function, first format microSD card using the transceiver.
- You cannot use this function while operating in the Access Point mode.

### NOTE:

- Even if no microSD card is inserted into the transceiver, a picture can be received, but the picture is not saved in RX Picture History.
  - ① A picture received before inserting a microSD card is deleted when you insert an SD card into the transceiver.
- **DO NOT** remove the microSD card from the transceiver while using the Share Picture function. Otherwise, the card data may be corrupted or deleted.
- If the card data is not in a supported format, or it is corrupted, an error dialog is displayed. In that case, select "YES" to delete the data that is not in a supported format or corrupted.

### About a picture file to use

- File type\*<sup>1</sup>: JPEG (The file extension is ".jpg.")
- Picture size\*<sup>2</sup>: 640 x 480, 320 x 240, or 160 x 120 (px)
- File size: 200 KB or less
- File name: up to 23 characters (except a filename extension)

\*<sup>1</sup> The transceiver cannot read a file whose extension is ".jpeg," or a file in the Progressive JPEG format.

\*<sup>2</sup> The transceiver cannot read a picture that is other than the specified size, even if its aspect ratio is 4:3.

① The transceiver displays only 500 pictures, even if you save more than 501 pictures onto the microSD card.

### About the free download software

With the ST-4001W (for Windows), ST-4001A (for Android), or ST-4001I (for iOS), you can add text and cut pictures down to size to send from the transceiver. When using the ST-4001A or ST-4001I, the edited picture can be transferred to the transceiver through Bluetooth.

① Before using, read each manual, and use these software according to the instructions.

① In this manual, ST-4001W, ST-4001A, and ST-4001I are described as "Picture Utility software."

### To transfer a picture to the transceiver

To transfer a picture to the transceiver through Bluetooth, connect your mobile device and your transceiver using the Bluetooth function. (p. 17-5)

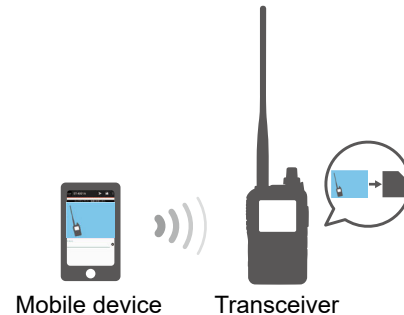

## Using the Picture screen

### [MENU] > PICTURE

1. Push [MENU].
2. Select "PICTURE."
  - The Picture screen is displayed.
  - ① To close the Picture screen, push [QUICK], and then select "<<Exit Picture Screen>>."

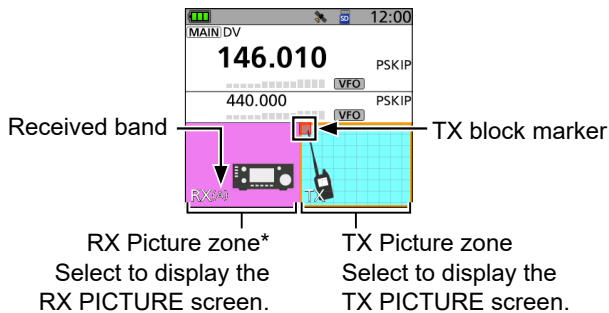

\* When signals that contain picture data are received on the MAIN and SUB bands at the same time, both pictures are saved on a microSD card, but a picture is displayed on only the MAIN band.

In the Quick Menu window, you can select the following options.

| Item                    | Action   |   |
|-------------------------|--|---|
| Picture TX              | OFF  | Turns OFF the Share Pictures function.  |
|                         | Single TX  | Turns ON the Share Pictures function.<br>① The picture is sent while transmitting. After the sending is completed, this function is turned OFF. |
|                         | Repeat TX  | The picture is repeatedly sent.   |
| <<TX All>>              | Sends the picture using the DV Fast Data function. |   |
| <<Back To 1st>>         | Moves the TX block marker back to the 1st block.   |   |
| <<Exit Picture Screen>> | Closes the Picture screen.                         |   |

### When a received signal contains picture data

When the received signal contains picture data, the RX Picture icon is displayed.

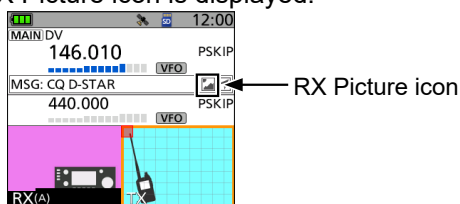

- ① You can turn OFF the RX Picture icon.  
([MENU] > SET > Display > **RX Picture Indicator**)

### The RX PICTURE screen

- Push [ENT] to display the RX PICTURE detail screen.
- Push D-pad(↑) to display the RX Picture history. (p. 14-7)

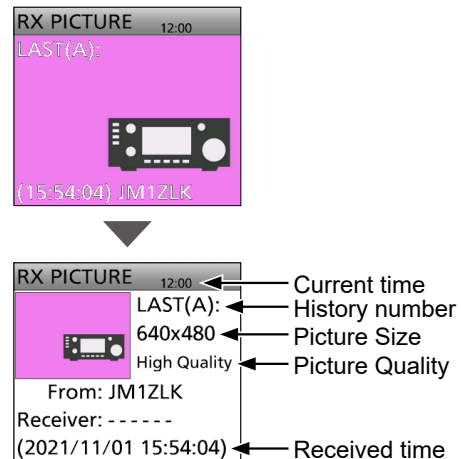

### The TX PICTURE screen

- Push [ENT] to display the TX PICTURE SET screen.
- Push D-pad(↑) to display the TX Picture history. (p. 14-7)

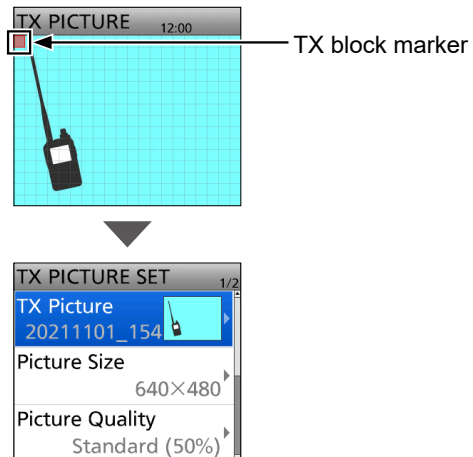

## Preparing a TX picture

There are 2 ways to prepare a TX picture.

- Transfer from a mobile device using the Picture Utility software, through Bluetooth.
- Save on a microSD card using the PC or mobile device.

### ◇ Transfer from the mobile device through Bluetooth

1. Insert a microSD card into the transceiver's slot, and then turn ON the transceiver.
2. In the mobile device, open the Picture Utility software.
  - ① When using an Android device for the first time, pair the transceiver with your device. (p. 17-7)
3. Open the Transfer Settings screen.
4. Select "Using Bluetooth," and then set "Transfer Devices" to your transceiver.
  - ① When using an iOS device for the first time, pair the transceiver with your device. (p. 17-9)
  - ① See the ST-4001A or ST-4001I instruction manual for details. They can be downloaded from the Icom website.
5. Open a picture to transfer using the Picture Utility software.
6. Touch the Transfer (📬) button.
  - Starts transferring, and the transferred picture is saved on the microSD card.
  - ① The file name is automatically set in the following format: yyyyymmdd\_hhmmss (yyyy: Year, mm: month, dd: day, hh: hour, mm: minute, ss: second).

**NOTE:** If you cannot transfer the picture, check the following:

#### On the transceiver

- The transceiver is turned ON.
- The Bluetooth function is ON.
- The transceiver's firmware is the latest version.
- A microSD card is inserted into the transceiver.
- The transceiver is in a normal operating mode.
  - ① The transceiver cannot receive the picture in special modes, such as the firmware update mode, clone mode, setting save mode, and import or export mode.

#### On the device

- The Bluetooth function is ON.
- "Transfer Devices" is set to your transceiver.

### ◇ Save on the microSD card using the PC or mobile device

1. Turn OFF the transceiver, then remove the microSD card from the transceiver.
2. Insert it into the microSD card drive or a memory card reader\* on your PC or mobile device.
  - \* User supplied.
3. Copy a picture file, and paste it in the "Picture" folder ("ID-52" > "Picture") on the card.
4. Remove the card from your device, and insert it into the transceiver's slot.

**NOTE:** Before you remove the SD card, be sure to electrically unmount it. Otherwise, the data may be corrupted or deleted.

#### TIP:

- When "USB Connect" is set to "SD Card Mode," and the transceiver is connected to the PC through a USB data cable, you can directly access the microSD card that is set in the transceiver from the PC.  
([MENU] > SET > Function > **USB Connect**)
- You can save a received picture in the "Picture" folder on the SD card. (p. 14-7)

## Sending the picture

### Step 1. Selecting a picture to send

- ① You can retransmit the picture in the TX PICT HISTORY screen. (p. 14-7)
- ① When you transfer the picture through Bluetooth, it is set to "TX Picture." If it is not necessary to change, go to "Step 2. Sending the picture."

#### [MENU] > PICTURE

1. Push [MENU].
2. Select "PICTURE."
3. Push D-pad (↔) to select the TX Picture zone, and then push [ENT].

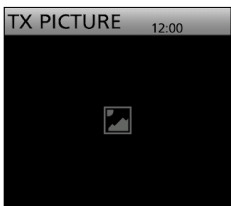
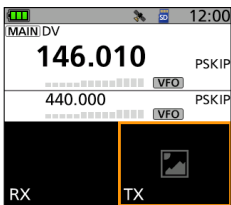

4. Push [ENT] again.
5. Select "TX Picture."

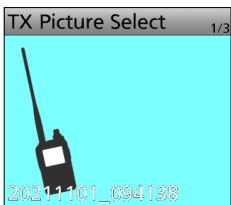
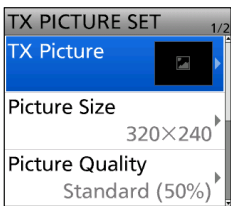

6. Rotate [DIAL] to select a picture.
  - ① You cannot view a picture if it is not in a supported format (p. 14-2), or is corrupted.
7. Push [ENT].
8. Set "Picture Size," "Picture Quality," and "Receiver."
  - ① See page 14-6 about each setting item.
9. To close the TX PICTURE SET screen, push [MENU].

### Step 2. Sending the picture

1. Push [QUICK].
2. Select "Picture TX."

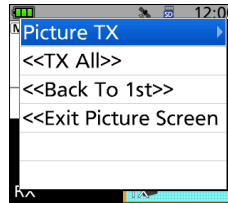

3. Select "Single TX" or "Repeat TX."

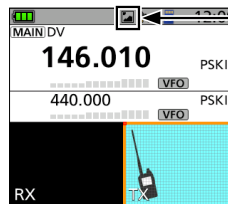
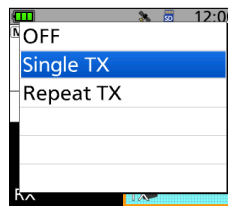

Displayed while the Share Pictures function is ON.

4. Hold down [PTT] to transmit.
  - ① The picture is sent while transmitting.
5. Release [PTT] to receive.

### Sending a picture using the DV Fast Data function

Select "<<TX All>>" in step 2 to send a picture using the DV Fast Data function.

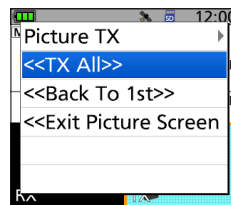

- ① **DO NOT** select "<<TX All>>" when you send a picture to other transceivers that can receive only slow speed data.
- ① While transmitting voice audio by holding down [PTT] on the microphone, the transceiver automatically changes to the Slow Speed Data mode.

# 14 SHARE PICTURES FUNCTION

## Sending the picture

### ◇ Moving the TX block marker

You can select the block to start sending.

① While sending a picture, you cannot move the TX block marker.

1. Push D-pad(↔) to select the TX Picture zone, and then push [ENT].
2. Push [QUICK].
3. Select "TX Picture Block Select."

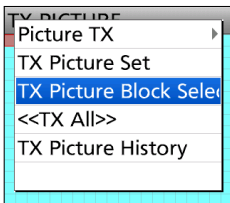

4. Rotate [DIAL] or push D-pad to move the TX block marker.

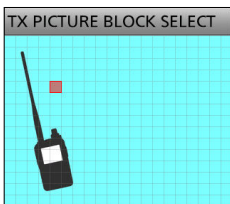

① To move the TX block marker back to 1st block, push [QUICK], and then select "BACK TO 1ST."

5. Push [ENT].
6. To close the TX PICTURE screen, push [MENU].

### ◇ TX PICTURE SET

This screen is used to set a picture, size, quality, and its intended destination to send.

① While sending a picture, you cannot change the settings.

1. Push D-pad(↔) to select the TX Picture zone, and then push [ENT].
2. Push [ENT] again.
3. Select the setting item.

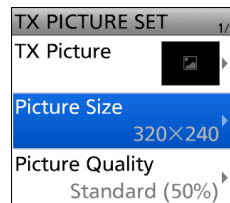

4. Select an option.

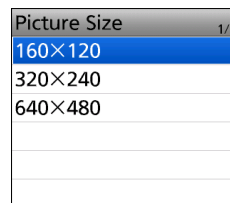

5. To close the TX PICTURE SET screen, push [MENU].

**TIP:** You can set each item to its default by pushing [QUICK], and then selecting "Default" on the Quick Menu window.

#### TX Picture

Select the picture to send, saved in the "Picture" folder ("ID-52" > "Picture") on the microSD card.

① When you set the TX Picture in the TX PICT HISTORY screen, "(RE TX)" is displayed before the file name.

#### Picture Size (Default: 320 x 240)

Set the desired size of a picture to send to "160 x 120," "320 x 240," or "640 x 480."

① You cannot select a size larger than the size of the picture.

#### Picture Quality (Default: Standard (50%))

Set the quality of a picture to send to "Low (25%)," "Standard (50%)," or "High (75%)."

#### Receiver (Default: -----)

Enter the receiver's call sign to let all stations that receive the picture know the picture's intended destination.

**NOTE:** All stations that receive the signal can see the picture, even if they are not set as the receiver.

## Viewing the pictures

### ◇ Viewing the RX Picture History

When you receive a DV call that has picture data, a received picture log is saved. Up to 50 history data can be saved. When you receive the 51st picture, the oldest history data is deleted.

**NOTE:** Confirm a microSD card is in the card slot.

#### [MENU] > PICTURE

1. Push [MENU].
2. Select "PICTURE."
3. Push D-pad(↔) to select the RX Picture zone, and then push [ENT].

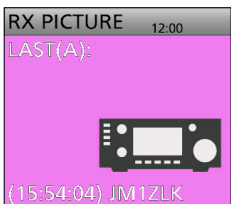
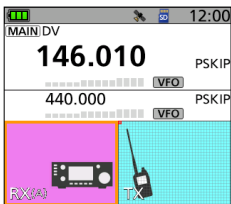

4. Rotate [DIAL] to select an RX picture history data.
5. Push [ENT].



- The RX picture history number, picture size, picture quality, the caller's call sign, receiver set by the caller, and RX date and time are displayed.

**TIP:** In the Quick Menu window, you can select the following options.

- **Zoom Picture:** Changes to enlarged display.
- **Save:** Saves the displayed picture onto the microSD card.
  - ① The file name is automatically set in the following format: Picyyyymmdd\_callsign\_xx (yyyy: Year, mm: month, dd: day, callsign: the caller's call sign, xx: serial number).
- **Delete:** Deletes the selected RX picture history data.
- **Delete All:** Deletes all RX picture history data.

### ◇ Viewing the TX Picture History

When you send a picture, the picture log is saved. Up to 50 history data can be saved. When you send the 51st picture, the oldest history data is deleted.

**NOTE:** Confirm a microSD card is in the card slot.

#### [MENU] > PICTURE

1. Push [MENU].
2. Select "PICTURE."
3. Push D-pad(↔) to select the TX Picture zone, and then push [ENT].

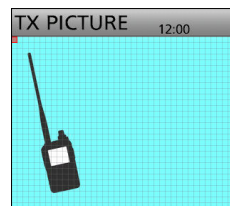
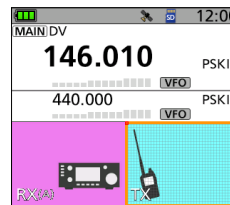

4. Rotate [DIAL] to select a TX picture history data.
5. Push [ENT].

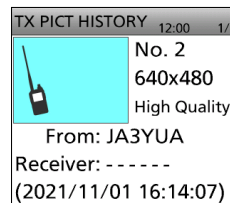

- The TX picture history number, picture size, picture quality, the caller's call sign, receiver, and TX date and time are displayed.

**TIP:** In the Quick Menu window, you can select the following options.

- **Retransmit:** Sets the picture to "TX Picture."
- **Zoom Picture:** Changes to enlarged display.
- **Delete:** Deletes the selected TX picture history data.
- **Delete All:** Deletes all TX picture history data.
  - ① You cannot delete when the selected TX picture history data is set to "TX Picture" (RE TX).
  - ① You cannot set the picture to "TX Picture" while transmitting a picture.

# 14 SHARE PICTURES FUNCTION

## Viewing the pictures

### ◇ Viewing the pictures in the “Picture” folder

You can view the pictures saved in the “Picture” folder on the microSD card.

- ① You cannot view the pictures while sending a picture.
- ① To save the received picture onto the microSD card, push [QUICK], and then select “Save” on the RX PICT HISTORY screen. (p. 14-7) Otherwise, the received picture is not saved in the “Picture” folder on the card.

#### [MENU] > SET > SD Card > TX/RX Picture View

1. Push [MENU].
2. Select “SD Card” in the “SET” menu.
3. Select “TX/RX Picture View.”

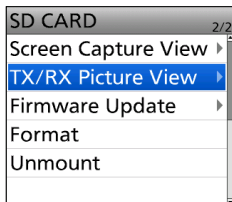

4. Select a picture to view.

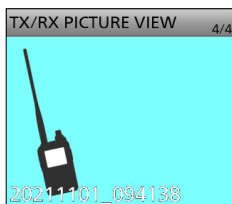
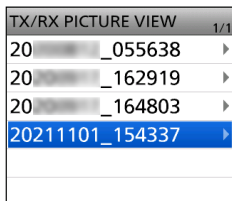

- ① You cannot view a picture if it is not in a supported format (p. 14-2) or it is corrupted.
- ① To exit the MENU screen, push [MENU].

**TIP:** In the Quick Menu window, you can select the following options.

- **File Information:** Displays the file name, size, and saved date.
- **Delete:** Deletes the selected picture.
- **Delete All:** Deletes all pictures.

# Section 15 OTHER FUNCTIONS

---

**NOTE:** See the Basic manual Section 6 for details on how to insert or remove a microSD card and precautions.

|  |       |
|--|-------|
| Band Scope function .....                          | 15-2  |
| ◇ Using the Band Scope function .....              | 15-3  |
| ◇ Using the Waterfall display .....                | 15-3  |
| Home Channel function .....                        | 15-4  |
| ◇ Setting a Home Channel .....                     | 15-4  |
| ◇ Home CH Beep function .....                      | 15-4  |
| Using the DTMF memory .....                        | 15-5  |
| ◇ Entering DTMF code .....                         | 15-5  |
| ◇ Monitoring the entered DTMF code .....           | 15-5  |
| Transmitting the DTMF code .....                   | 15-6  |
| ◇ Transmitting the entered DTMF code .....         | 15-6  |
| ◇ Transmitting a DTMF code (Direct Input) .....    | 15-6  |
| ◇ Selecting the DTMF transmit speed .....          | 15-7  |
| Tone squelch operation .....                       | 15-8  |
| DTCS code squelch operation .....                  | 15-9  |
| VOX function .....                                 | 15-10 |
| ◇ Selecting the headset type .....                 | 15-10 |
| ◇ Using the VOX function .....                     | 15-11 |
| ◇ Setting the VOX level .....                      | 15-11 |
| ◇ VOX-related settings .....                       | 15-12 |
| Weather channel operation (USA version only) ..... | 15-13 |
| ◇ Selecting a Weather channel .....                | 15-13 |
| ◇ Weather alert function .....                     | 15-13 |
| Screen Capture function .....                      | 15-14 |
| ◇ Setting the Screen Capture function .....        | 15-14 |
| ◇ Capturing a screen .....                         | 15-14 |
| ◇ Viewing the captured screen .....                | 15-14 |
| Setting the Opening picture .....                  | 15-15 |
| Cloning .....                                      | 15-16 |
| Resetting .....                                    | 15-18 |
| ◇ Partial Reset .....                              | 15-18 |
| ◇ All Reset .....                                  | 15-18 |

## Band Scope function

Use the Band Scope function to visually search a specified frequency range around the displayed frequency. You can use this function to search for a signal, and see the relative received signal strength level.

On the single band display, you can confirm the signal strengths over time by the waterfall function.

On the single band display within 137 ~ 174 MHz and 375 ~ 479 MHz, you can hear the displayed frequency's audio during a sweep.

The Band Scope function has 2 sweep types.

- **Single Sweep:** Searches the specified frequency range only once. The Single Sweep starts from the lower frequency, and the sweep stops after reaching the upper frequency.
- **Continuous Sweep:** Repeatedly searches the specified frequency range.

The transceiver's sweep bandwidth is  $\pm 15^* \times$  the tuning step number, centered on the operating frequency.

\* You can change the displayed steps to  $\pm 20$  steps.  
 ([MENU] > SET > Scope > **Displayed Steps**)

### During a sweep in the Center mode

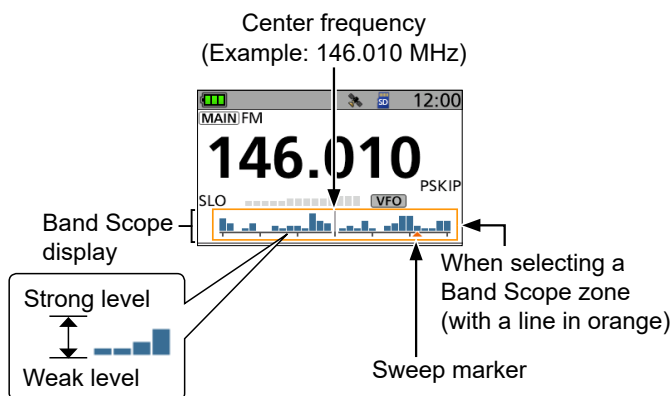

### While stopping a sweep

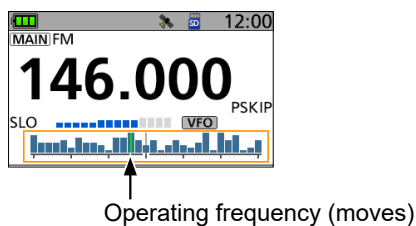

You can select the Band Scope display mode from three modes, the Center mode, the FIX mode, and the Scroll (FIX) mode.

### Center mode

Displays signals around the operating frequency within the selected span.

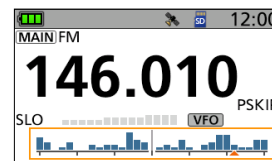

### FIX mode

Displays signals within a specified frequency range.

- ① Set the displayed frequency range on the MENU screen.  
 (p. 12-7)  
 ([MENU] > SET > Scope > FIX Mode Center Frequency)

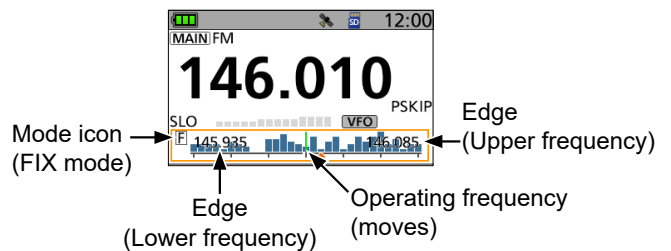

When the operating frequency moves outside the upper or lower Edge frequency, "▶" or "◀" is displayed in the upper side corners of the Band Scope screen.

### Scroll (FIX) mode

Displays signals within a specified frequency range. When the operating frequency moves outside of the screen, the displayed frequency range is automatically shifted.

- ① Set the displayed frequency range on the MENU screen.  
 (p. 12-7)  
 ([MENU] > SET > Scope > FIX Mode Center Frequency)

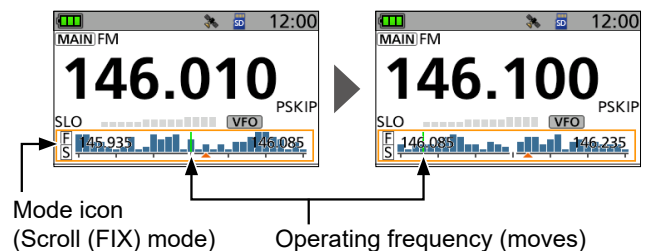

## Band Scope function

**NOTE:** During the continuous sweep, the noise may occur if you bring your hand or body close to the screen.

### ◇ Using the Band Scope function

[MENU] > SCOPE

1. Push [MENU].
2. Select "SCOPE."



- Returns to the standby screen, and starts the continuous sweep.

3. Push [QUICK].
4. Select "Scope Mode."

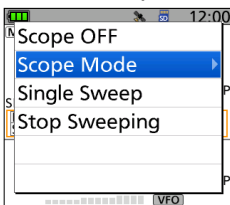

5. Select the Band Scope display mode.
  - Displays the selected display mode, and starts the continuous sweep.
6. Push [ENT].
  - Stops the sweep.
  - ① Push [ENT] again, to resume the sweep for the Continuous Sweep function.
7. When the sweeping stops, rotate [DIAL] to move the sweep marker to a detected signal.
  - You can hear the signal audio.
  - ① While the sweep is paused, push [CLR] to turn OFF the Band Scope function.

### Band Scope screen operation

| Key      | Action   |
|----------|--|
| [DIAL]   | Rotate to select an operating frequency.   |
| D-pad(↑) | Push to cancel the Band Scope zone selection.  |
| D-pad(↓) | Push to select the Band Scope zone (with a line in orange).  |
| [ENT]    | Push to start or stop a sweep.   |
| [QUICK]  | Push to open the Quick Menu window.<br>① When selecting the Band Scope zone, only the Band Scope menu is displayed.  |
| [CLR]    | When selecting the Band Scope zone: <ul style="list-style-type: none"> <li>• Push to stop the sweep during a sweep.</li> <li>• Push to turn OFF the Band Scope function while stopping a sweep.</li> </ul> |

### ◇ Using the Waterfall display

On the single band display, you can turn the waterfall display ON or OFF.

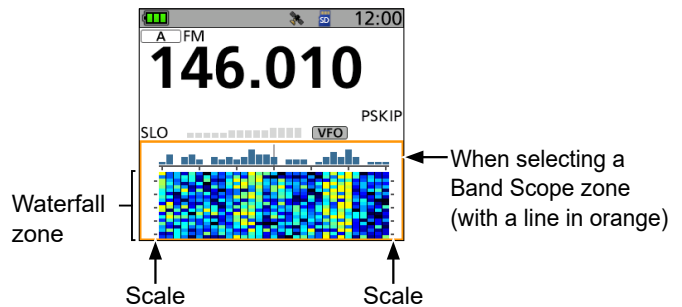

### ① Information

- Higher signal levels are Red, Yellow, Green, Light-blue, Blue, and Black (no signal), in that order.
- During a sweep, the scales on both sides of the waterfall zone are moved with the waterfall. While stopping a sweep, the scales and the waterfall also freeze.
- You can select the Waterfall speed.  
([MENU] > SET > Scope > **Waterfall Speed**)

### TIP:

- If the tuning step is set too wide, the signals in the sweep range may not be displayed (they may be skipped), even if they are strong signals. Therefore, we recommend that you set the tuning step to 20 kHz or less to use the Band Scope function. See the Basic manual Section 3 for details on how to set the tuning step.
- On the AIR band, you cannot hear the displayed frequency's audio during a sweep. When "AF Output (DUAL/AIR Band)" is set to ON, the received audio is momentarily output during a sweep, and you will know that a signal is received without looking at the display.
  - You can turn "AF Output (DUAL/AIR Band)" ON or OFF on the MENU screen. (p. 12-30)
  - The FM Radio audio output may be interrupted due to the AF Output (DUAL/AIR Band) function. In that case, set "AF Output (DUAL/AIR Band)" to OFF, or set "Auto Mute" to OFF.  
([MENU] > SET > Scope > **AF Output (DUAL/AIR Band)**)  
([MENU] > FM RADIO > FM Radio Set > **Auto Mute**)

## Home Channel function

You can set an often-used frequency, Memory channel, or repeater as a Home Channel in VFO mode, Memory mode, and DR screen.

### ◇ Setting a Home Channel

1. Select the VFO or Memory mode, or the DR screen to set a Home Channel.
2. Select a frequency, Memory channel, or an access repeater to be set as a Home Channel.
3. Push [QUICK].
4. Select "Home CH Set."

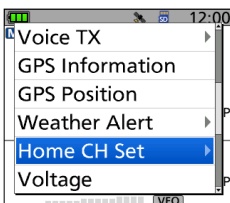

5. Select "Set Frequency" (VFO mode), "Set Channel" (Memory mode), or "Set Repeater" (DR screen).

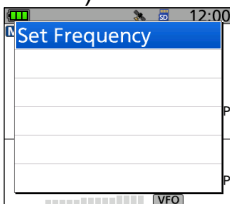

- Sets a Home Channel, then returns to the standby screen.

**TIP:** Selecting "Clear" in Step 4 clears the Home channel setting.

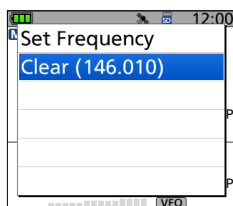

### ◇ Home CH Beep function

When a Home CH is selected by rotating [DIAL], a beep sounds. You will know the Home CH selection without looking at the display.

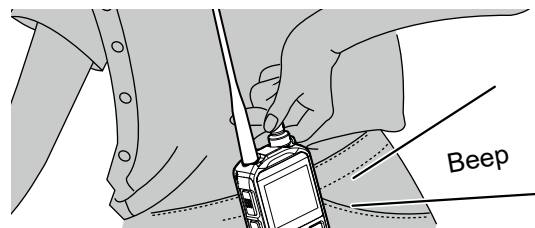

You can assign the [Home CH] key function to an optional microphone key or optional Bluetooth headset. (pp. 12-18, 12-34)

- ① You can turn OFF the Home CH Beep function on the MENU screen.  
([MENU] > SET > Sounds > Home CH Beep)

## Using the DTMF memory

The transceiver can save up to 16 memories of a 24 digit DTMF code.

### ◇ Entering DTMF code

[MENU] > SET > DTMF/T-CALL > **DTMF Memory**

1. Push [MENU].
2. Select “DTMF/T-CALL” in the “SET” menu.
3. Select “DTMF Memory.”

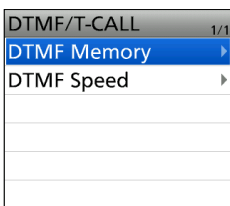

4. Select a DTMF Memory to enter.

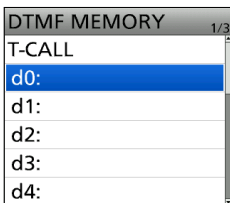

① **DO NOT** push [ENT].

5. Push [QUICK].
6. Select “Edit.”

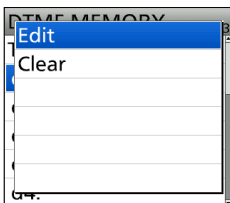

7. Enter a DTMF code, then push [ENT].  
(Example: 123456A)

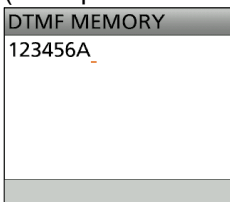

- Saves the Memory, and returns to the DTMF MEMORY screen.

① See page iii on how to enter characters.  
① To exit the MENU screen, push [MENU].

**TIP:** To clear the entered DTMF code, push [QUICK] on the DTMF MEMORY screen, then select “Clear.”

### ◇ Monitoring the entered DTMF code

You can check and hear the entered DTMF code.

[MENU] > SET > DTMF/T-CALL > **DTMF Memory**

1. Push [MENU].
2. Select “DTMF/T-CALL” in the “SET” menu.
3. Select “DTMF Memory.”
4. Select a DTMF Memory to monitor.

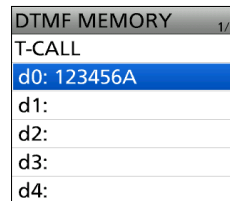

① **DO NOT** push [ENT].

5. Push [SQL].

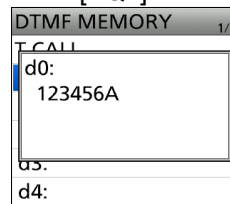

- The DTMF code sounds.
- After sounding, returns to the DTMF MEMORY screen.

① To exit the MENU screen, push [MENU].

**TIP:** You can also check the DTMF code by pushing [QUICK] and select “DTMF Monitor” on the DTMF MEMORY screen in step 4.

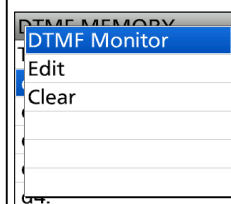

## Transmitting the DTMF code

### ◇ Transmitting the entered DTMF code

[MENU] > SET > DTMF/T-CALL > DTMF Memory

1. Push [MENU].
2. Select “DTMF/T-CALL” in the “SET” menu.
3. Select “DTMF Memory.”

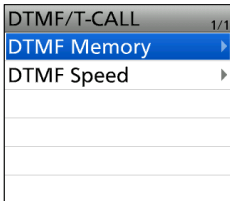

4. Select a DTMF Memory to transmit.

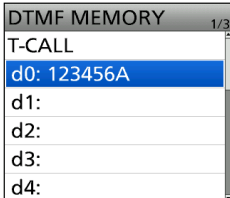

- The selected DTMF channel is set to transmit.
5. Push [MENU].
    - Exits the MENU screen.
  6. While holding down [PTT], push [SQL].



- The selected DTMF code in step 4 is transmitted.
- Even if you release [PTT], the transceiver keeps transmitting the code until all the code is transmitted.

**TIP:** In the standby screen, you can transmit a DTMF code by pushing [QUICK], selecting “DTMF TX,” and selecting a code.

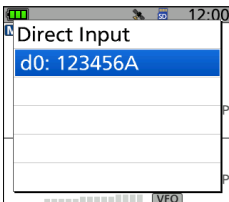

### ◇ Transmitting a DTMF code (Direct Input)

1. Push [QUICK].
2. Select “DTMF TX.”

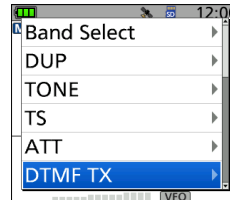

3. Select “Direct Input.”



4. Enter a DTMF code, then push [ENT].  
(Example: 012345#)



- Transmits the entered DTMF code.
- ① The DTMF code scrolls during transmission.
- ① See page iii on how to enter characters.

**TIP: About the 1750 Hz tone**  
When you select “T-CALL” on the DTMF MEMORY screen, a 1750 Hz tone can be transmitted.

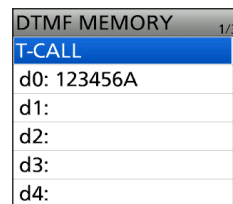

- While holding down [PTT], push [SQL].
- The 1750 Hz tone is transmitted.
  - ① You can hear the 1750 Hz tone from a speaker.

## Transmitting the DTMF code

### ◇ Selecting the DTMF transmit speed

You can select the DTMF transmit speed.

[MENU] > SET > DTMF/T-CALL > **DTMF Speed**

1. Push [MENU].
2. Select “DTMF/T-CALL” in the “SET” menu.
3. Select “DTMF Speed.”

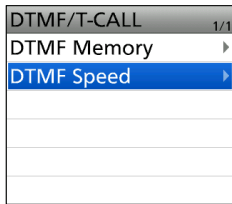

4. Select a transmit speed. (Default: 100ms)

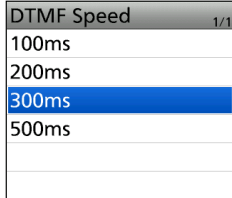

① To exit the MENU screen, push [MENU].

### The image of transmitting the DTMF code

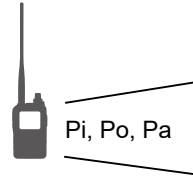

When “100ms” is selected, the DTMF transmit speed is fast.

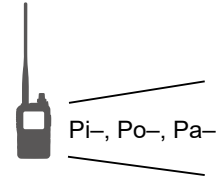

When “500ms” is selected, the DTMF transmit speed is slow.

## Tone squelch operation

The tone squelch opens only when you receive a signal that includes a matching subaudible tone in the FM or FM narrow (FM-N) mode. You can silently wait for calls from other stations using the same tone. Also, the reversed tone squelch function mutes the squelch when a signal including a matching subaudible tone.

### Step 1. Setting the tone squelch frequency

[MENU] > SET > DUP/TONE... > TSQL Freq

1. Push [VFO/MHz] to enter the VFO mode.
2. Push [MODE] to select the FM or FM-N mode.
3. Rotate [DIAL] to set an operating frequency.
4. Push [MENU].
5. Select "DUP/TONE..." in the "SET" menu.
6. Select "TSQL Freq."

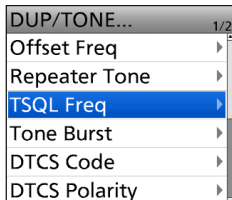

7. Rotate [DIAL] to set a Tone Squelch frequency, then push [ENT].

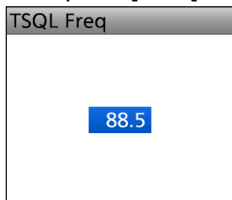

- ① Set to between 67.0 and 254.1 Hz.
- ① To exit the MENU screen, push [MENU].

### Step 2. Using the tone squelch

1. Push [QUICK].
2. Select "TONE."

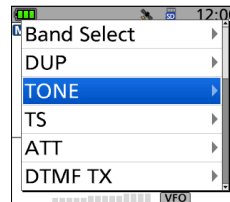

3. Select the Tone Squelch type.

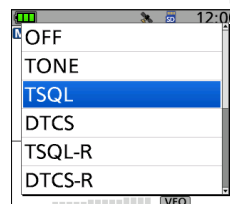

4. Operate normally.
  - You will only hear the audio of stations that are using the same Tone Squelch frequency. All other signals will be muted.

#### About the Tone squelch types indication

- TSQL: Enables the Tone Squelch function.
- TSQL-R: Enables the Reverse Tone Squelch function.
- TONE(T)/DTCS(R) ("T-DTCS" is displayed, "T" blinks.):
  - When you transmit, the selected subaudible tone is superimposed on your normal signal.
  - When you receive, the DTCS squelch opens only for a signal that includes a matching DTCS code and polarity. (Audio is heard)
- DTCS(T)/TSQL(R) ("D-TSQL" is displayed, "D" blinks.):
  - When you transmit, the selected DTCS code is superimposed on your normal signal.
  - When you receive, the tone squelch opens only for a signal that includes a matching tone frequency. (Audio is heard)
- TONE(T)/TSQL(R) ("T-TSQL" is displayed, "T" blinks.):
  - When you transmit, the selected subaudible tone is superimposed on your normal signal.
  - When you receive, the tone squelch opens only for a signal that includes a matching tone frequency. (Audio is heard)

## DTCS code squelch operation

The tone squelch opens only when you receive a signal that includes a matching DTCS code in the FM or FM narrow (FM-N) mode. You can silently wait for calls from others using the same tone. Also, a reversed tone squelch function mutes the squelch when you receive a signal including a matching DTCS code.

### Step 1. Setting the DTCS code

[MENU] > SET > DUP/TONE... > DTCS Code

1. Push [VFO/MHz] to enter the VFO mode.
2. Push [MODE] to select the FM or FM-N mode.
3. Rotate [DIAL] to set an operating frequency.
4. Push [MENU].
5. Select "DUP/TONE..." in the "SET" menu.
6. Select "DTCS Code."

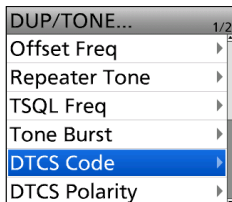

7. Rotate [DIAL] to set a DTCS code, then push [ENT].

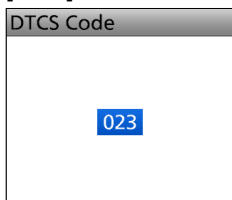

- ① Set to between 023 and 754.
- ① To exit the MENU screen, push [MENU].

### Step 2. Using the DTCS code squelch

1. Push [QUICK].
2. Select "TONE."

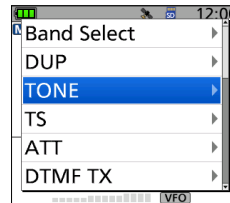

3. Select the DTCS code type.

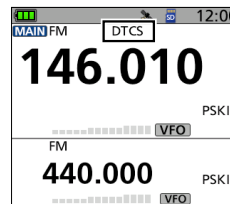
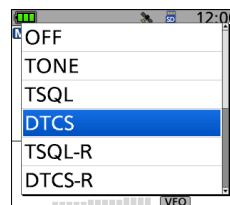

4. Operate normally.
  - You will only hear the audio of stations that are using the same DTCS code. All other signals will be muted.

#### About the DTCS code types indication

- DTCS: Enables the DTCS Squelch function.
- DTCS-R: Enables the Reverse DTCS Squelch function.
- DTCS(T) ("DTCS" blinks.):  
When you transmit, the selected DTCS code is superimposed on your normal signal.  
When you receive, the function is OFF.
- TONE(T)/DTCS(R)  
("T-DTCS" is displayed, "T" blinks.):  
When you transmit, the selected subaudible tone is superimposed on your normal signal.  
When you receive, the DTCS squelch opens only for a signal that includes a matching DTCS code and polarity. (Audio is heard)
- DTCS(T)/TSQF(R)  
("D-TSQF" is displayed, "D" blinks.):  
When you transmit, the selected DTCS code is superimposed on your normal signal.  
When you receive, the tone squelch opens only for a signal that includes a matching tone frequency. (Audio is heard)

## VOX function

The Voice Operated eXchange (VOX) function toggles the transceiver between transmit and receive by your voice. This function provides hands-free operation. You can use the VOX function with the optional HS-94, HS-95, or HS-97 HEADSET and the OPC-2006LS PLUG ADAPTER CABLE.

**NOTE: BE SURE** to turn OFF the transceiver when plugging or unplugging the OPC-2006LS into or from the [MIC/SP] jack.

**TIP:** You can also use the VOX function with the Bluetooth headset.  
 ([MENU] > SET > Bluetooth Set > Headset Set > **VOX**)  
 See page 13-5 for details.

### ◇ Selecting the headset type

[MENU] > SET > Function > VOX > **Headset Select**

1. Push [MENU].
2. Select "Function" in the "SET" menu.
3. Select "VOX."

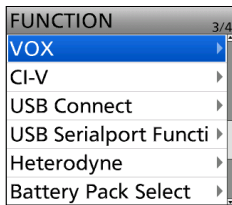

4. Select "Headset Select."

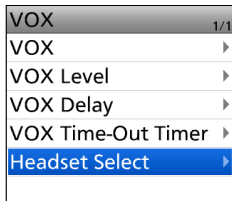

5. Select an option.

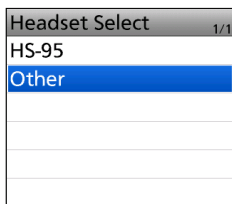

- **HS-95:** Select when using the HS-95.
- **Other:** Select when using the HS-94 or the HS-97.

ⓘ To exit the MENU screen, push [MENU].

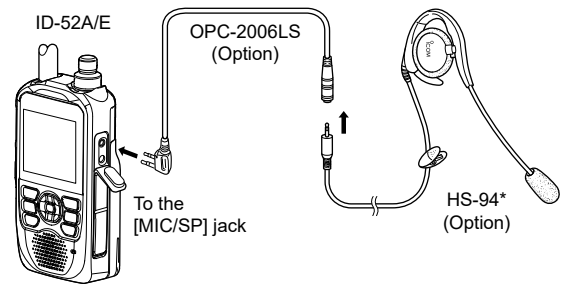

\* You can also use this function with the optional HS-95 or HS-97.

## VOX function

### ◇ Using the VOX function

[MENU] > SET > Function > VOX > **VOX**

1. Push [MENU].
2. Select "Function" in the "SET" menu.
3. Select "VOX."

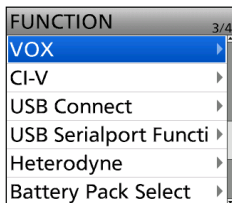

4. Select "VOX."

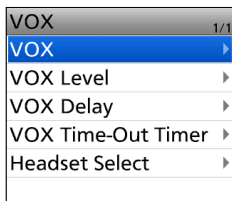

5. Select "ON."

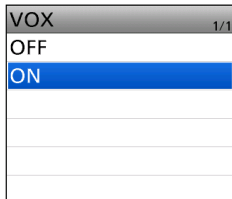

6. To exit the MENU screen, push [MENU].



- When you connect the HS-94, HS-95, or HS-97 headset, "VOX" is displayed on the standby screen.

**NOTE:** While receiving a signal, or sounding a beep, the transceiver does not switch to transmit by your voice.

### ◇ Setting the VOX level

**NOTE:** We recommend you set the Microphone Gain level to 3, before setting the VOX level. ([MENU] > SET > Function > **MIC Gain (External)**)

[MENU] > SET > Function > VOX > **VOX Level**

1. Push [MENU].
2. Select "Function" in the "SET" menu.
3. Select "VOX."

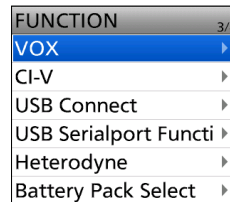

4. Select "VOX Level."

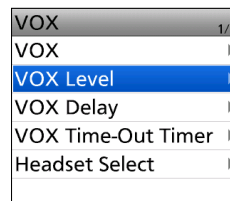

5. While speaking into the microphone, rotate [DIAL] to adjust the VOX level.

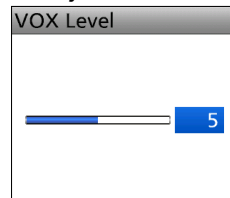

- Displays "VOX" when the TX level audio is input.
  - ① The VOX level can be adjusted between 1 (minimum) and 10 (maximum), or turned OFF. (Default: 5)
  - ① Higher values make the VOX function more sensitive to your voice.
6. To exit the MENU screen, push [MENU].
    - ① If the S-meter does not display the output power level, and the transceiver does not transmit, adjust the VOX delay time. ([MENU] > SET > Function > VOX > **VOX Delay**)
    - ① When the VOX function is ON, you can adjust the VOX level by rotating [DIAL] while transmitting.

---

# 15 OTHER FUNCTIONS

## VOX function

### ◇ VOX-related settings

You can set the “VOX Delay” and “VOX Time-Out Timer” on the MENU screen.

#### VOX Delay

[MENU] > SET > Function > VOX > **VOX Delay**

The VOX delay is the amount of time the transmitter stays ON after you stop speaking. It enables normal pauses in speaking. (p. 12-22)

| VOX Delay | 1/1 |
|-----------|-----|
| 0.5sec    |     |
| 1.0sec    |     |
| 1.5sec    |     |
| 2.0sec    |     |
| 2.5sec    |     |
| 3.0sec    |     |

#### VOX Time-Out Timer

[MENU] > SET > Function > VOX > **VOX Time-Out Timer**

The VOX Time-Out Timer prevents prolonged accidental transmission. (p. 12-22)

| VOX Time-Out Timer | 1/2 |
|--------------------|-----|
| OFF                |     |
| 1min               |     |
| 2min               |     |
| 3min               |     |
| 4min               |     |
| 5min               |     |

## Weather channel operation (USA version only)

There are 10 weather channels for monitoring the National Oceanographic and Atmospheric Administration (NOAA) weather broadcasts.

### ◇ Selecting a Weather channel

1. Push [MR] to enter the Weather Channel mode.
  - ① Pushing [MR] each time selects the Memory and Weather Channel modes.



2. Rotate [DIAL] to select a weather channel.
  - Displays the selected weather channel number ("WX-01" ~ "WX-10").

### ◇ Weather alert function

NOAA broadcast stations transmit weather alert tones before important weather announcements.

When the weather alert function is turned ON, the selected weather channel is monitored every 5 seconds for an announcement.

When an alert signal is detected, the "ALT" and the WX channel are alternately displayed, and a beep sounds until you change the mode or weather channel, turn OFF the Weather Alert function, or turn OFF the transceiver.

The previously selected (used) weather channel is checked periodically during standby, or while scanning.

1. Push [QUICK].
2. Select "Weather Alert."

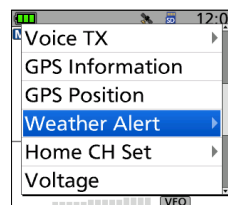

3. Select "ON."

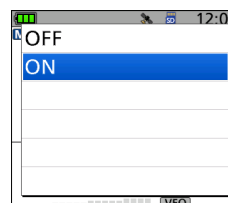

- Turns ON the Weather Alert function, and "WX" is displayed.

## Screen Capture function

You can capture the transceiver display onto a microSD card. Most of the screens used in this manual are captured using this function. However, some displays cannot be captured.

### ◇ Setting the Screen Capture function

[MENU] > SET > Function >  
Screen Capture [PWR] Key

1. Push [MENU].
2. Select "Function" in the "SET" menu.
3. Select "Screen Capture [PWR] Key."

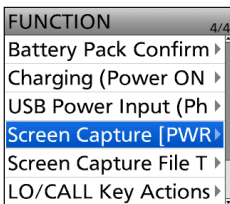

4. Select "ON."

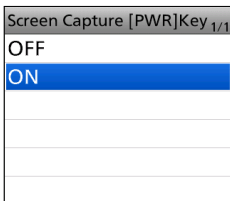

① To exit the MENU screen, push [MENU].

### ◇ Capturing a screen

1. Display the desired screen to capture.
2. Push [PWR] to capture the screen.
  - The captured screen is saved onto the card.

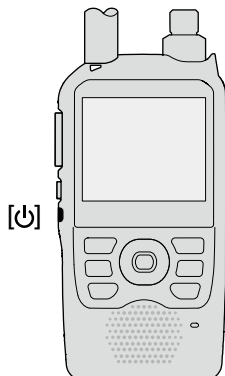

### ◇ Viewing the captured screen

[MENU] > SET > SD Card > Screen Capture View

1. Push [MENU].
2. Select "SD Card" in the "SET" menu.
3. Select "Screen Capture View."

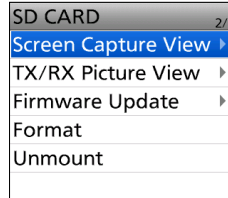

- The capture list is displayed.
  - The latest screen capture is at the bottom of the list.
4. Select the desired screen capture to display it.

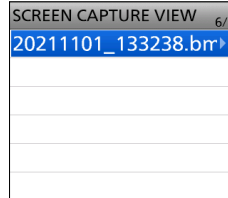

- The screen capture is displayed.
- ① While a screen capture is displayed, you can scroll through all the screen captures by rotating [DIAL].
- ② To exit the MENU screen, push [MENU].

### Checking the file information and deleting a file

1. Select the screen capture that you want to view or delete.
  - ① **DO NOT** push [ENT].
2. Push [QUICK].
3. Select an item from "File Information," "Delete," and "Delete All."

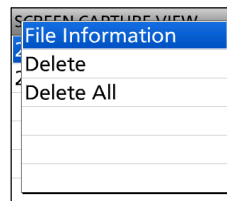

- **File Information:** Displays the file name, size, and date of the selected screen capture.
- **Delete:** Deletes the selected file.
- **Delete All:** Deletes all files.

## Setting the Opening picture

You can set a picture that is displayed at power ON.

**NOTE:** To set the displayed picture, a microSD card (user supplied) is required.

### About a picture file to use

- File type: 24 bit bitmap  
(The file extension is "bmp.")
- Picture size: 320 x 280 (px)
- File name: Up to 23 characters  
(except the filename extension)

### Step 1. Saving a picture on the microSD card

(PC)

1. Copy a picture file into the "OpeningPicture" folder ("ID-52" > "OpeningPicture") on the microSD card.  
① See page 2-5 for detail.
2. Insert the microSD card into the transceiver.

### Step 2. Setting the displayed picture

(Transceiver)

[MENU] > SET > SD Card > **Opening Picture**

1. Push [MENU].
2. Select "SD Card" in the "SET" menu.
3. Select "Opening Picture."

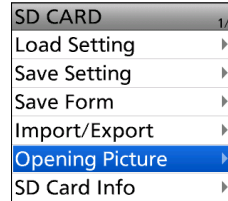

4. Select a picture to display.

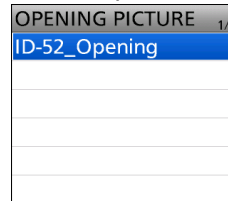

- The selected picture is displayed.
5. Push [ENT].  
① To select the picture again, push [CLR].  
• The confirmation dialog is displayed.
  6. Select "YES."  
• The transceiver will automatically restart, and the selected picture is displayed.

### To hide the picture at power ON

Select "<<Cancel Opening Picture Setting>>" in step 4.

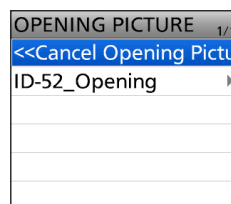

- ① The selected picture can be displayed even if:
- No microSD card is inserted.
  - You do a Partial Reset or All Reset.

## Cloning

The transceiver has a data cloning capability. This function is useful when you want to copy all of the settings and entered contents from one ID-52A/ID-52E to another. This section describes the cloning method using a microSD card.

### Step 1. Saving the master transceiver's setting data onto the microSD card.

[MENU] > SET > SD Card > **Save Setting**

1. Push [MENU].
2. Select "SD Card" in the "SET" menu.
3. Select "Save Setting."

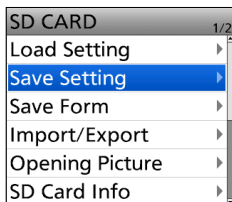

4. Select "<<New File>>."

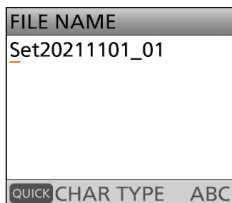
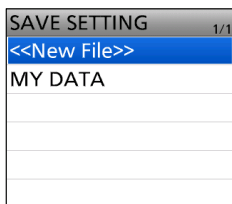

- ① The file name is automatically set in the following format: Setyyyymmdd\_xx (yyyy: Year, mm: month, dd: day, xx: serial number).

5. Push [ENT] to save the file with the displayed name.
  - The confirmation dialog is displayed.
6. Select "YES."

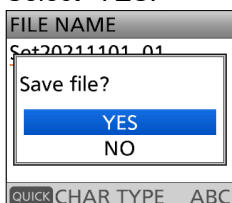

- While saving, a progress bar is displayed, then returns to the SD CARD screen after the saving is completed.

- ① To exit the MENU screen, push [MENU].

- ① Recorded voice memories are not included in the cloning data. To play back the master transceiver's voice memory, insert the microSD card into a sub transceiver, or make a copy onto the sub transceiver's microSD card using a PC.
- ① Assumes that the microSD card has already been inserted into the transceiver.

### Step 2. Remove the microSD card from the master transceiver, then insert it into the sub transceiver.

1. Turn OFF the master transceiver.
2. Remove the microSD card from the master transceiver.
3. Insert the card into the sub transceiver, then turn ON the sub transceiver.

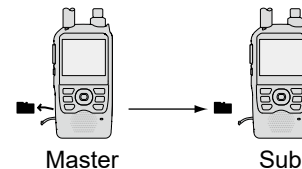

#### NOTE:

- Turn OFF the transceiver before you insert or remove the microSD card.
- **DO NOT** turn OFF the transceiver while saving or loading the setting data. Otherwise, the data may be corrupted or deleted.

**TIP:** The setting data is saved in the "icf" file format that is used in the CS-52 PROGRAMMING SOFTWARE. When the saved data on a card is copied to a PC, you can edit it with the programming software. For details, refer to the CS-52 instructions that can be downloaded from the Icom website.

(Continue the steps on the next page.)

## Cloning

### Step 3. Loading the setting data into the sub transceiver.

[MENU] > SET > SD Card > **Load Setting**

1. Push [MENU].
2. Select "SD Card" in the "SET" menu.
3. Select "Load Setting."

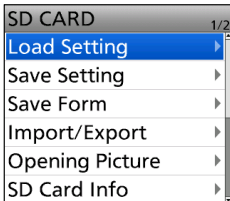

4. Select a data file to load into the transceiver.

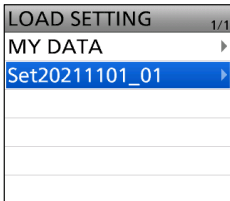

5. Select the loading content.

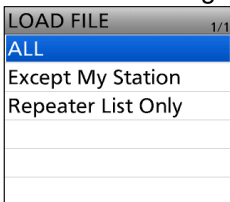

- **ALL:**  
Loads all Memory channels, settings on the MENU screen, and the Repeater List into the transceiver.
- **Except My Station:**  
Loads all Memory channels, setting on the MENU screen except MY call signs, and the Repeater List into the transceiver.
- **Repeater List Only:**  
Loads only the Repeater List into the transceiver.

6. Select "YES" or "NO."

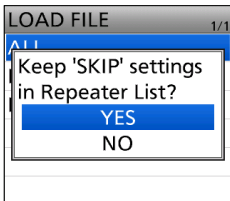

- **YES:**  
The skip settings of the Repeater List are retained. (p. 5-39)
- **NO:**  
The skip settings of the Repeater List are cleared.

7. Select "YES."

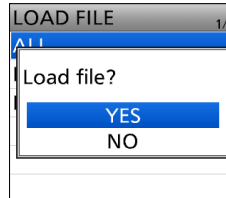

- Starts checking and loading the data file.
- After loading, "COMPLETED!" is displayed.

8. Restart the transceiver to operate with the new setting.

## Resetting

Occasionally, erroneous information may be displayed. This may be caused by static electricity or by other factors.

If this problem occurs, turn OFF the transceiver. After waiting a few seconds, turn ON the transceiver again. If the problem still exists, perform a **Partial reset**. If the problem still exists after performing a Partial reset, perform an **All reset**.

### ◇ Partial Reset

A Partial Reset resets the operating settings to their defaults without clearing the following:

- Memory Channel contents
- Call Channel contents
- Radio Memory contents
- Scan Edge contents
- Message data
- GPS memory contents
- Call sign memories
- DTMF memory contents
- Repeater list
- Bluetooth pairing list
- Opening picture

[MENU] > SET > Others > Reset > **Partial Reset**

1. Push [MENU].
2. Select "Others" in the "SET" menu.
3. Select "Reset."

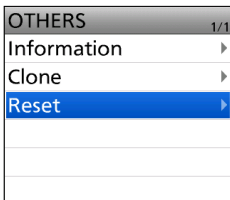

4. Select "Partial Reset."

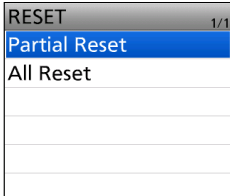

- The confirmation dialog is displayed.

5. Select "YES."

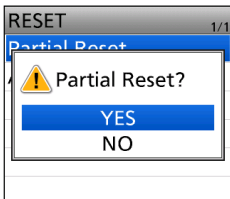

- "PARTIAL RESET" is displayed, and then the display automatically returns to the default screen.

**NOTE for the All reset:** After performing an All reset, you cannot use the DR function because the Repeater List contents are also cleared. We recommend you save the setting data onto a microSD card, or to your PC using the CS-52 PROGRAMMING SOFTWARE before performing an All reset. After the All reset is finished, load or write the saved data into your transceiver.

### ◇ All Reset

An All reset clears all data and returns all settings to their factory defaults. Memory channel contents, filter settings, and so on will all be cleared, so you will need to rewrite your operating settings unless you have a backup.

- ① The Bluetooth pairing list and opening picture are not deleted.

[MENU] > SET > Others > Reset > **All Reset**

1. Push [MENU].
2. Select "Others" in the "SET" menu.
3. Select "Reset."

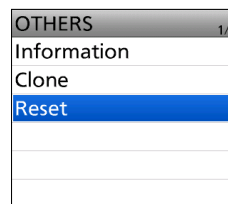

4. Select "All Reset."

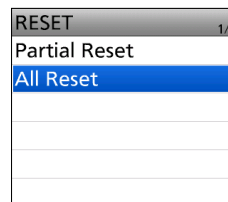

- The confirmation dialog is displayed.

5. Select "YES."

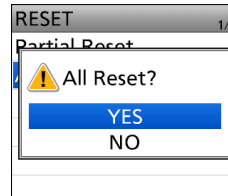

- "ALL RESET" is displayed, and then the display automatically returns to the default screen.

# Section 16 UPDATING THE FIRMWARE

---

**NOTE:** See the Basic manual Section 6 for details on how to insert or remove a microSD card and precautions.

|                                       |      |
|---------------------------------------|------|
| General.....                          | 16-2 |
| ◇ About updating the firmware .....   | 16-2 |
| ◇ Checking the firmware version ..... | 16-2 |
| ◇ Preparation .....                   | 16-3 |
| ◇ Unzipping the firmware folder.....  | 16-3 |
| Updating the firmware .....           | 16-4 |

## General

### ◇ About updating the firmware

You can update the ID-52A/E's firmware using a microSD card. Updating the firmware adds new functions and/or improves performance parameters. You can download the latest firmware from the Icom website.

<https://www.icomjapan.com/support/>

**IMPORTANT:** To update the firmware, first format your microSD card using the ID-52A/E. Then copy the downloaded firmware data from your PC into the "ID-52" folder on the card.

### ◇ Checking the firmware version

Check the firmware version on the VERSION screen.

[MENU] > SET > Others > Information > **Version**

1. Push [MENU].
2. Select "Others" in the "SET" menu.
3. Select "Information."

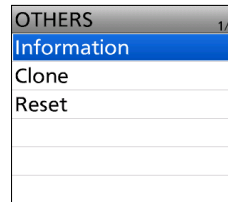

4. Select "Version."

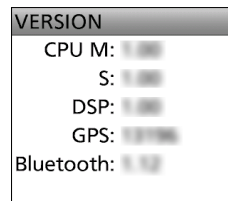
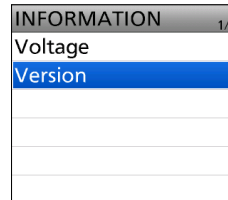

- The VERSION screen is displayed.
- ① To exit the VERSION screen, push [MENU].

**TIP:** You can also check the firmware version when you turn ON the transceiver.

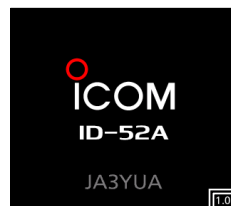

The firmware version is displayed.

# 16 UPDATING THE FIRMWARE

## General

### ◇ Preparation

Access the following URL and download the firmware file.

<https://www.icomjapan.com/support/>

① These instructions are based on Microsoft® Windows® 10.

1. Click the “Firmware/Software” link.



2. Enter “ID-52” into the Search box, and then click [Search].

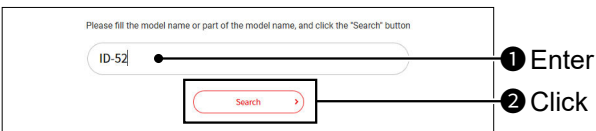

3. Click the desired firmware file link.
4. Carefully read “Regarding this Download Service.” Click “Agree,” and then click [Download].

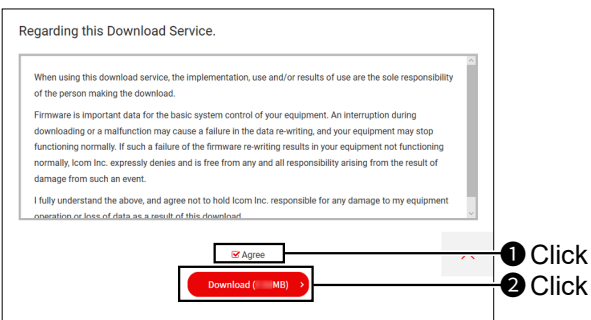

5. Click “Save as” in the displayed File Download dialog.

6. Select the location where you want to save the firmware, and then click [Save] in the displayed File Download dialog.

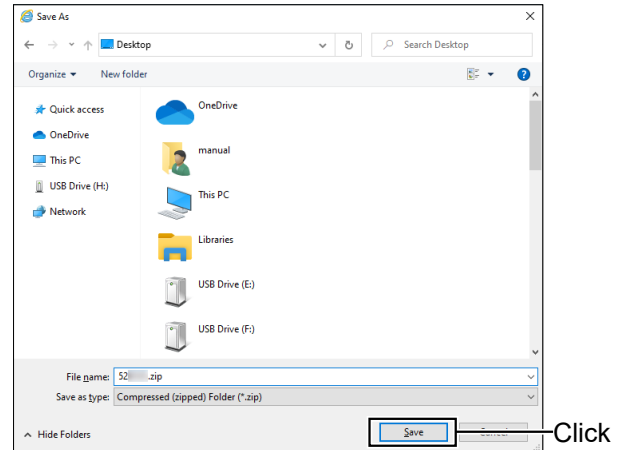

- The file starts downloading.
- The firmware and the firm utility are compressed in a “zip” format folder. Unzip it before use.

### ◇ Unzipping the firmware folder

1. Right-click the downloaded firmware folder (zip format).
  - The right-click menu is displayed.
2. Click “Extract All...”



- After unzipping, a folder is created in the same location as the downloaded folder.

- ① In the “52\*” folder, “52\*.dat” is created.  
\* Represents the release number.

## Updating the firmware

**CAUTION: NEVER** turn OFF the transceiver while updating the firmware. If you turn OFF the transceiver, or if a power failure occurs while updating, the transceiver firmware may be damaged, and, if so, you will have to send the transceiver back to the nearest Icom distributor for repair. This type of repair is out of warranty, even if the transceiver warranty period is still valid.

**Recommendation!**  
Fully charging of battery pack before starting the firmware update is strongly recommended. This is to avoid failure during the update, caused by an unexpected power failure.

**TIP: BE SURE** to unzip the downloaded file. See the previous page for details.

- Copy the downloaded firmware data into the "ID-52" folder on to a microSD card.

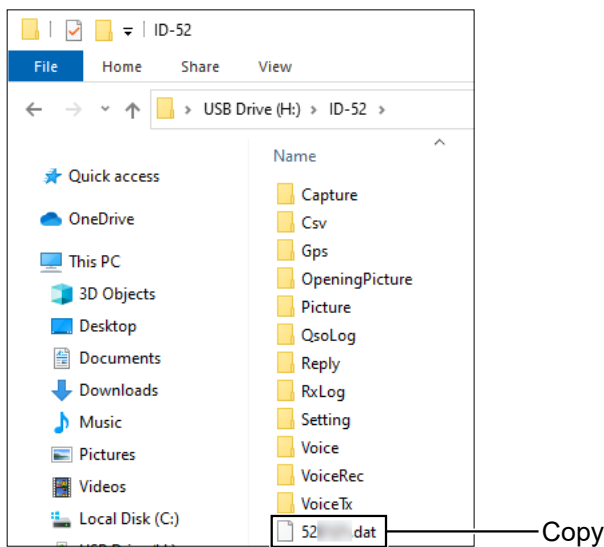

- Insert the microSD card into the transceiver.
- Display the SD CARD screen.

[MENU] > SET > SD Card

- Select "Firmware Update."

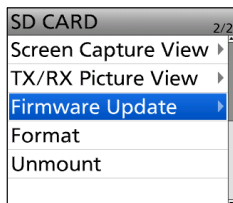

- After you read and agree with all the precautions, select "YES."

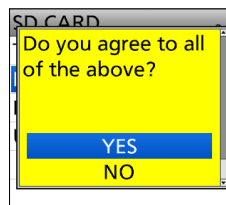
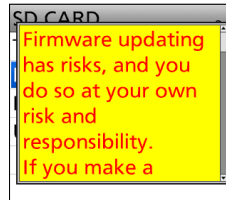

- Scroll the screen and read all the precautions.
- The confirmation dialog is displayed. When you select "YES," the backup file is made on the microSD card, and then the Firmware selection screen is displayed.

- Select the Firmware (Example: 52\*).  
\* Represents the release number.

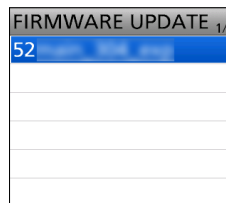

- The final confirmation screen is displayed. Carefully read all the displayed precautions.

- After you read and agree with all the precautions, select "YES."

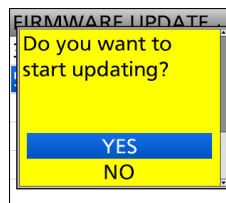

- The updating starts.

- When the update is completed, "Firmware updating has completed." is displayed in the dialog.

- The transceiver will automatically restart.
- ① After the updating finishes, the operating screen is displayed.

**TIP:** When "USB Connect" is set to "SD Card Mode," and the transceiver is connected to the PC through a USB data cable, you can directly access the microSD card that is set in the transceiver from the PC. ([MENU] > SET > Function > **USB Connect**)

# Section 17    OPTIONS

---

|   |       |
|---|-------|
| Option list.....  | 17-2  |
| Optional HM-75LS REMOTE CONTROL SPEAKER MICROPHONE .....                | 17-4  |
| ◇ Assigning a Remote Control function .....                             | 17-4  |
| When using an application .....   | 17-5  |
| ◇ About compatible applications.....                                    | 17-5  |
| ◇ Required items .....  | 17-5  |
| ◇ Download procedures (Android device) .....                            | 17-6  |
| ◇ Download procedures (iOS device).....                                 | 17-6  |
| ◇ When using a USB cable .....  | 17-6  |
| Connecting an Android™ device to the transceiver through Bluetooth® ... | 17-7  |
| ◇ Pairing with an Android device .....                                  | 17-7  |
| ◇ Connection .....  | 17-8  |
| Connecting an iOS device to the transceiver through Bluetooth® .....    | 17-9  |
| ◇ Pairing with an iOS device .....                                      | 17-9  |
| ◇ Connection .....  | 17-10 |

## Option list

You can find information for these options on the Icom website.

<https://www.icomjapan.com/support/>

① Some options may not be available, depending on the transceiver version.

### Batteries/Chargers

#### BC-167SA/BC-167SD BATTERY CHARGER

The same as supplied.

The shape may be different, depending on the charger version.

#### BC-202IP2 RAPID CHARGER

+ **BC-123SA/BC-123SE (L-shaped type plug)**  
AC ADAPTER

#### BC-202IP3L RAPID CHARGER

+ **BC-123SA/BC-123SE (Straight type plug)**  
AC ADAPTER (For single unit)

+ **BC-228** AC ADAPTER (For multiple units)

#### BP-271 Li-ion BATTERY PACK

Voltage: 7.4 V

Discharge capacity: 1150 mAh (minimum), 1200 mAh (typical)

Battery life: Approximately 4.25 hours (FM)

#### BP-272 Li-ion BATTERY PACK

The same as supplied.

Voltage: 7.4 V

Discharge capacity: 1880 mAh (minimum), 2000 mAh (typical)

Battery life: Approximately 7.25 hours (FM)

#### BP-273 BATTERY CASE

Uses 3 LR6 (AA) alkaline batteries.

#### BP-307 Li-ion BATTERY PACK

Voltage: 7.2 V

Discharge capacity: 3050 mAh (minimum), 3150 mAh (typical)

Battery life: Approximately 12 hours (FM)

### Headsets/Earphones

#### HS-94/HS-95/HS-97 HEADSET

+ **OPC-2006LS** PLUG ADAPTER CABLE

HS-94: Ear hook type

HS-95: Neck and arm type

HS-97: Throat microphone

OPC-2006LS: Connects the HS-94/HS-95/HS-97 to the transceiver for the VOX function.

#### HM-153LS EARPHONE MICROPHONE

#### HM-166LS EARPHONE MICROPHONE

Smaller than the HM-153LS.

#### SP-40 EARPHONE

+ **OPC-2144** PLUG ADAPTER CABLE

When using the SP-40, you need the OPC-2144 slim L type conversion cable.

### Speaker microphones

#### HM-75LS REMOTE CONTROL SPEAKER MICROPHONE

#### HM-183LS SPEAKER MICROPHONE

Meets IPX7 requirements for waterproof protection (1 meter, 3.3 ft depth for 30 minutes).

#### HM-186LS SPEAKER MICROPHONE

Meets IPX4 requirements for waterproof protection (Splashing water from any direction).

### Cables

#### CP-12L CIGARETTE LIGHTER CABLE

With noise filter.

Fuse Coding: FUSE 125V 3A

Fuse Voltage Rating: 125 Volts

Fuse Current Rating: 3 Amperes

#### OPC-254L DC POWER CABLE

Directly connects to a DC power source.

Fuse Coding: FUSE 250V 3A

Fuse Voltage Rating: 250 Volts

Fuse Current Rating: 3 Amperes

#### CP-23L CIGARETTE LIGHTER CABLE

For BC-202IP2, 12 V

① You cannot connect to the transceiver's [DC IN] jack.

#### OPC-515L DC POWER CABLE

For BC-202IP2

① You cannot connect to the transceiver's [DC IN] jack.

#### CP-25H CIGARETTE LIGHTER CABLE

For BC-202IP3L, 12 V

① You cannot connect to the transceiver's [DC IN] jack.

#### OPC-2417 DATA CABLE (USB micro-B/USB micro-B)

#### OPC-2418 DATA CABLE (USB micro-B/USB Type-C)

### Others

#### AD-92SMA ANTENNA CONNECTOR ADAPTER

Connects an antenna or antenna cable that has a BNC connector.

#### FA-S270C VHF/UHF ANTENNA

The same as supplied.

#### LC-193 CARRYING CASE

① You cannot use when the BP-307 is attached to the transceiver.

#### MB-127 BELT CLIP

The same as supplied.

#### VS-3 Bluetooth® HEADSET

## Option List

| <b>About the free download software</b> |  |
|---|--|
| CS-52                                   | PROGRAMMING SOFTWARE                     |
| RS-MS1A (For Android devices)           | Android APPLICATION                      |
| RS-MS1I (For iOS™ devices)              | iOS™ APPLICATION                         |
| RS-MS3A (For Android devices)           | TERMINAL MODE/ACCESS POINT MODE SOFTWARE |
| RS-MS3W (For Windows)                   | TERMINAL MODE/ACCESS POINT MODE SOFTWARE |
| ST-4001A (For Android devices)          | PICTURE UTILITY SOFTWARE                 |
| ST-4001I (For iOS devices)              | PICTURE UTILITY SOFTWARE                 |
| ST-4001W (For Windows)                  | PICTURE UTILITY SOFTWARE                 |

You can download each manual and guide from the Icom website.  
**<https://www.icomjapan.com/support/>**

① Before using, read each manual and guide, and use it according to the instructions.  
To add or expand a function, or to improve the performance, the software version may be upgraded.  
Before you update your software version, see the instructions and cautions described on the Icom website.

## Optional HM-75LS REMOTE CONTROL SPEAKER MICROPHONE

The optional HM-75LS enables you to remotely select operating frequencies, Memory channels, and other functions.

You can assign some functions to the keys on the HM-75LS for simple remote control operation. (p. 12-18)

The HM-75LS has a lock switch on the back to prevent accidental frequency changes.

**NOTE:**

- **BE SURE** to turn OFF the transceiver when plugging or unplugging the HM-75LS into or from the [MIC/SP] jack.
- Firmly plug the HM-75LS into the transceiver.

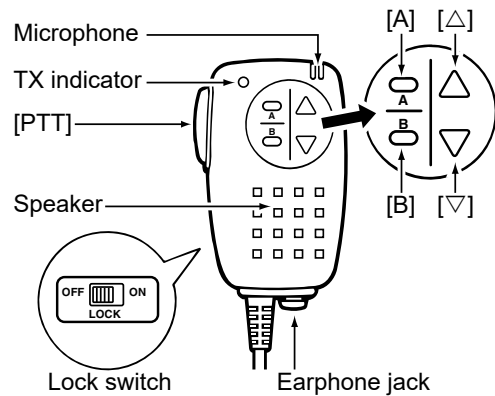

### ◇ Assigning a Remote Control function

**Example:** Assigning the “TO (DR)” function to the [A] key.

[MENU] > SET > Function > **Remote MIC Key**

1. Push [MENU].
2. Select “Function” in the “SET” menu.
3. Select “Remote MIC Key.”

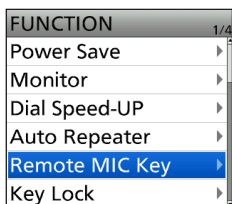

4. Select “During RX/Standby.”

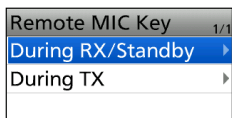

5. Select “[A].”

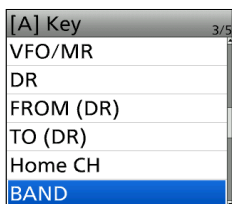
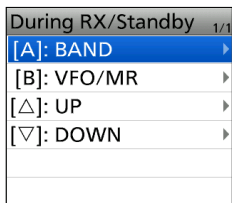

- The Assignable function list is displayed.
- ① About the functions, see pages 12-19 and 12-20.

6. Select “TO (DR).”

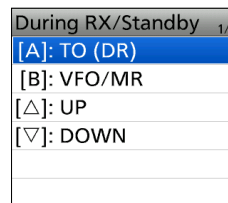
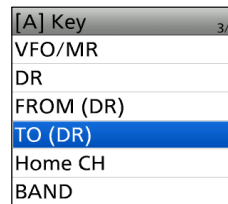

- The “TO (DR)” function is assigned.
- ① To exit the MENU screen, push [MENU].

**TIP: To return to the default settings**

- On the “During RX/Standby” screen or “During TX” screen, push [QUICK] and select “Default All.”
- On the each key screen, push [QUICK] and select “Default.”

## When using an application

The following applications are compatible with the Android or iOS device.

See each application's manual for details.

Download the applications from your device.

### ◇ About compatible applications

The following applications are compatible with ID-52A/  
ID-52E. (As of November 2021)

#### Android device

- RS-MS1A: You can use the extended D-STAR functions to exchange pictures or messages or display the received D-PRS station data on a map application.
- RS-MS3A: You can use the DV Gateway function.
- ST-4001A: You can make an image to be used for the Share Picture function, and transfer it to the transceiver.

#### iOS device

- RS-MS1I: You can use the extended D-STAR functions to exchange pictures or messages or display the received D-PRS station data on a map application.
- ST-4001I: You can make an image to be used for the Share Picture function, and transfer it to the transceiver.

### ◇ Required items

#### Android device

You can use the RS-MS1A/RS-MS3A/ST-4001A with devices that have Android 5.0 or later installed.

① The applications have been tested with the Android 5.x.x, 6.x.x, 7.x.x, 8.x.x, 9.0, and 10.0. (As of November 2021)

#### iOS device

You can use the RS-MS1I/ST-4001I with devices that have iOS version 12 or later, iPadOS version 13 or later installed.

① The ST-4001I has been tested with iOS 12 and 13, and iPadOS 13. (As of November 2021)

#### Disclaimer

- The application may not work properly, depending on the OS version, installed applications, or other reasons.
- The indications or items may differ, depending on the OS version or settings.

#### When using a USB cable

##### • Android device

Android 5.0 or later with the USB host function.

##### • Cable (purchase separately)

OPC-2417 data cable (USB micro-B/USB micro-B)  
or  
OPC-2418 data cable (USB micro-B/USB Type-C)

**TIP:** The USB host function is needed to use a USB device with an Android device. To check whether or not your Android device has the USB host system, ask the Android device's manufacturer.

#### When using the Bluetooth function

##### • Android device or iOS device

Android 5.0 or later with the Bluetooth function.

or

iOS version 12 or later, iPadOS version 13 or later with the Bluetooth function.

① When using the RS-MS3A, you cannot connect an Android device to the transceiver through Bluetooth.

#### **NOTE:** Some functions may not work correctly,

- depending on other applications installed in the Android device.
- depending on the memory capacity.

## When using an application

### ◇ Download procedures (Android device)

1. Turn ON your Android device.
2. Touch "Play Store."
3. Enter the application's name in the search field.
  - ① Do not abbreviate the application name to be sure to find it.
4. Touch "🔍."
  - The application's name will be displayed as the search result.
  - ① If your Android device does not support the application, its name may not appear on the search result.
5. Touch the application to install.
  - Displays the introduction screen of the application.
6. Touch <INSTALL>.
  - Installation starts.
  - After finishing the installation, the icon is displayed on the screen.

### ◇ Download procedures (iOS device)

1. Turn ON your iOS device.
2. Touch "App Store."
3. Enter the application's name in the search field.
  - ① Do not abbreviate the application name to be sure to find it.
4. Touch "🔍."
  - The application's name will be displayed as the search result.
  - ① If your iOS device does not support the application, its name may not appear on the search result.
5. Touch the application to install.
  - Displays the introduction screen of the application.
6. Touch <GET>.
  - Installation starts.
  - After finishing the installation, the icon is displayed on the screen.

### ◇ When using a USB cable

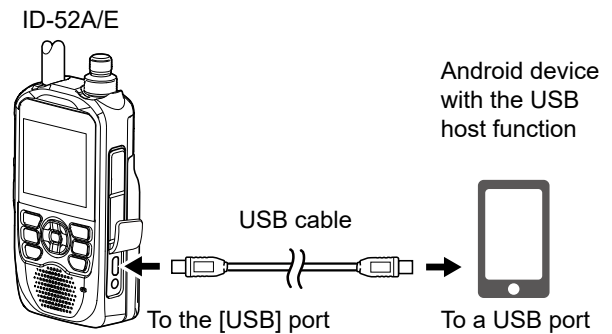

- ① Connect the USB micro-B connector (for the OPC-2417: with the white tube) to the transceiver and the other connector to an Android device.

#### NOTE:

- Turn OFF the transceiver before connecting or removing the cable.
- When an Android device is connected, the USB connection indicator (USB COM) is displayed on the transceiver. If the indicator is not displayed, enable your Android device to detect the USB device.
  - ① No operation is required on a mobile device that support automatic detection of the USB devices.
- When using RS-MS1A, confirm the following items are set.
  - ([MENU] > SET > Function > **CI-V**)
  - Set "CI-V Address" to the value same as the RS-MS1A side. (Default: A6)
  - ① RS-MS1A side: Application Settings → CI-V settings (Default: Transceiver[A6])
  - Set "CI-V Transceiver" to "ON."
- ([MENU] > SET > Function > **USB Serialport Function**)
- Set "USB SerialPort Function" to "CI-V (Echo Back OFF)."
- ([MENU] > SET > Function > **USB Connect**)
- Set "USB Connect" to "Serialport."
- When using Access Point mode, RS-MS1A cannot be used.
- Remove the USB cable when you do not use the cable. Otherwise, the battery will be quickly exhausted.

## Connecting an Android™ device to the transceiver through Bluetooth®

Before connecting to an Android device, you must pair with it. See the next page about connecting to the transceiver with an Android device using the RS-MS1A application.

### ◆ Pairing with an Android device

This section describes how to pair with an Android device.

**NOTE:** You may not be able to pair with it, depending on the Bluetooth device.

#### Step 1. Entering the Pairing Reception mode (Transceiver)

[MENU] > SET > Bluetooth Set > <<Pairing Reception>>

1. Push [MENU].
2. Select "Bluetooth Set" in the "SET" menu.
3. Select "<<Pairing Reception>>."

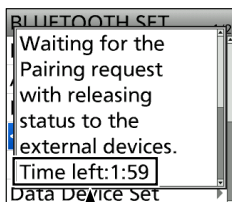
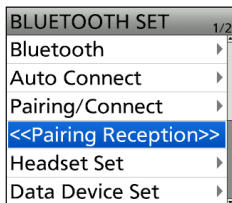

Turn ON Bluetooth with your Android device within the displayed period. When the time runs out, the transceiver exits the Pairing Reception mode.

#### Step 2. Turning ON Bluetooth (Android device)

Turn ON Bluetooth with your Android device.

- The Android device displays the transceiver Bluetooth unit's name.
- ① You can confirm the transceiver Bluetooth unit's name on the BLUETOOTH DEVICE INFO screen. (Default: ICOM BT(ID-52)) (p. 13-7)
- ① See the instruction manual of the Android device for details.

#### Step 3. Sending a pairing request to the transceiver (Android device)

Select the displayed transceiver Bluetooth unit's name to send a pairing request.

- The Android device starts to send a pairing request.
- The Android device displays, "To pair with: ICOM BT(ID-52). Make sure it is showing this passkey: \* \* \* \* \*."

#### Step 4. Receiving a pairing request (Transceiver)

1. When the transceiver receives a pairing request, confirm the displayed passkey is the same as yours, and then select "CONFIRM."

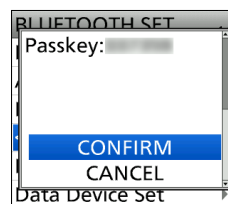
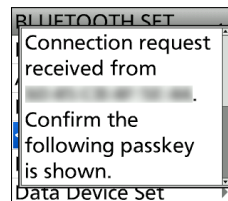

- Pairing starts.
2. Select "Pairing/Connect."

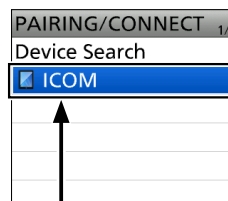
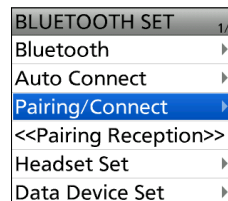

Pairing list

After the pairing is complete, the Android device name is displayed on the pairing list.

**NOTE:** When you pair with a third party's data device, entering a PIN code or passkey may be required. See the instruction manual of the data device for details on how to enter a PIN code or passkey.

## Connecting an Android™ device to the transceiver through Bluetooth®

### ◇ Connection

This section describes how to connect an Android device to the transceiver, using the RS-MS1A application.

Before connecting, pair the transceiver with the Android device. (p. 17-7)

① When using the ST-4001A application, the transceiver and Android device are automatically connected while transferring a picture.

#### Step 1. Preparing for the connection (Transceiver)

[MENU] > SET > Function > CI-V > **CI-V Transceiver**

Set “CI-V Transceiver” to ON to control the transceiver and the RS-MS1A with CI-V commands.

#### Step 2. Starting the RS-MS1A (Android device)

Touch the RS-MS1A to start.

① See page 17-6 for details on downloading the RS-MS1A.

#### Step 3. Connecting to the transceiver (Android device)

Touch the transceiver’s Bluetooth unit name displayed on the RS-MS1A.

- Starts to connect.

① When your call sign has not been entered in the transceiver, you should enter it before you connect.

① After the connection has been made, the transceiver displays “\* \* \* Connected.” and the Bluetooth icon is displayed.

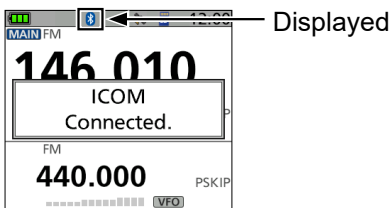

① On the PAIRING/CONNECT screen, “⚡” is displayed.

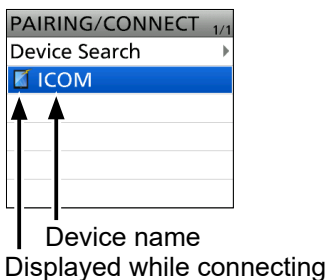

#### TIP: To connect to the Android device from the transceiver

When the RS-MS1A is started on the Android device, you can connect to the device from the transceiver.

[MENU] > SET > Bluetooth Set > **Pairing/Connect**

1. Push [MENU].
2. Select “Bluetooth Set” in the SET menu.
3. Select “Pairing/Connect.”
4. Select the Android device name displayed in the pairing list.
5. Select “YES.”
  - Displays “\* \* \* Connecting...” ( “\* \* \* ” is the Bluetooth name of the Android device.)
  - ① On the PAIRING/CONNECT screen, “⚡” is displayed on the data device icon.

**NOTE:** If you cannot connect, check that the same CI-V address is set in the transceiver and the RS-MS1A.

You can see the CI-V setting as described below:

#### Transceiver

“CI-V Address” in the MENU screen.

([MENU] > SET > Function > CI-V > **CI-V Address**)  
(Default: A6)

#### RS-MS1A:

“Application Settings” → “CI-V settings”  
(Default: Transceiver[A6])

## Connecting an iOS device to the transceiver through Bluetooth®

Before connecting to an iOS device, you must pair with it.

### ◆ Pairing with an iOS device

This section describes how to pair with an iOS device.

#### NOTE:

- You cannot pair with an iOS device in its Settings app. To pair with an iOS device, use Icom application.
- You may not be able to pair with it, depending on the Bluetooth device.

#### NOTE: When using the RS-MS11

Before connecting, check that the following items are correctly set.

- Set “CI-V Transceive” to ON in the transceiver. ([MENU] > SET > Function > CI-V > **CI-V Transceive**)
- Set the same CI-V address in the transceiver and the RS-MS11.

#### Transceiver:

“CI-V Address” in the MENU screen.

([MENU] > SET > Function > CI-V > CI-V Address)  
(Default: A6)

#### RS-MS11:

- “Application Settings” → “Select the default” (Default: Auto Select)
- “Application Settings” → “CI-V address” (Default: Auto Setting)

### Step 1. Starting the application (iOS device)

1. Turn ON Bluetooth in your iOS device.  
① See the instruction manual of the iOS device for details.
2. Touch the application’s icon to start.

### Step 2. Entering the pairing reception mode (Transceiver)

[MENU] > SET > Bluetooth Set > <<Pairing Reception>>

1. Push [MENU].
2. Select “Bluetooth Set” in the “SET” menu.
3. Select “<<Pairing Reception>>.”

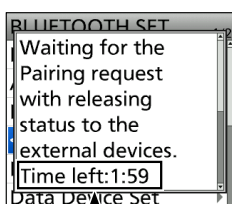
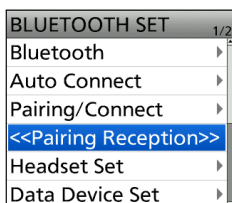

Send a pairing request to the transceiver (step. 3) within the displayed period. When the time runs out, the transceiver exits the Pairing Reception mode.

### Step 3. Sending a pairing request to the transceiver (iOS device)

1. On the application, touch “Scan.”
  - For the RS-MS11, the item is displayed in “Other” > “Bluetooth Connection.”
  - For the ST-4001I, the item is displayed in “Transfer Device List.” (“...” > Transfer Settings > Using Bluetooth > **Transfer Device List**)
  - The iOS device displays the transceiver Bluetooth unit’s name.
  - ① You can confirm the transceiver Bluetooth unit’s name on the BLUETOOTH DEVICE INFO screen. (Default: ICOM BT(ID-52)) (p. 13-7)
2. Select the displayed transceiver Bluetooth unit’s name to send a pairing request.
  - The iOS device starts to send a pairing request.
  - After the pairing has succeeded, “Pairing is complete.” is displayed.

#### About the transceiver’s display

After the connection has been made, the transceiver displays “\* \* \* Connected.” and the Bluetooth icon is displayed.

(“\* \* \*” is the Bluetooth name of the iOS device.)

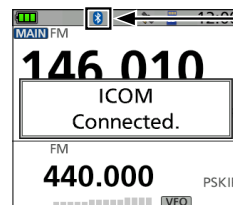

Displayed

- ① On the PAIRING/CONNECT screen, “👉” is displayed.

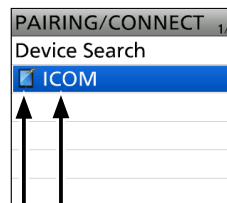

Device name  
Displayed while connecting

Connecting an iOS device to the transceiver through Bluetooth®

## ◇ Connection

This section describes how to connect to a paired transceiver from an iOS device.  
 Before connecting, pair the transceiver with the iOS device. (p. 17-7)

① When using the ST-4001I application, the transceiver and Android device are automatically connected while transferring a picture.

### Step 1. Starting the RS-MS1I (iOS device)

Touch the RS-MS1I to start.

① See page 17-6 for details on downloading the RS-MS1I.

### Step 2. Connecting to the transceiver (iOS device)

1. Touch "Other."
  2. Touch "Bluetooth Connection."
  3. Touch the displayed transceiver Bluetooth unit's name to connect.
    - Starts to connect.
- ① When your call sign has not been entered in the transceiver, enter it before you connect.
- ① If the connection has been made, the transceiver displays "\*\*\* Connected.," and the Bluetooth icon is displayed.

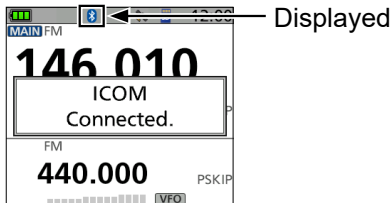

Displayed

① On the PAIRING/CONNECT screen, "⚡" is displayed.

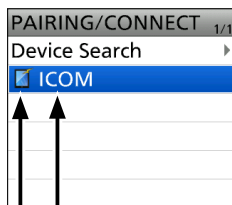

Device name  
Displayed while connecting

#### TIP: To connect to the iOS device from the transceiver

When the RS-MS1I is started on the iOS device, you can connect to the device from the transceiver.

[MENU] > SET > Bluetooth Set > **Pairing/Connect**

1. Push [MENU].
  2. Select "Bluetooth Set" in the SET menu.
  3. Select "Pairing/Connect."
  4. Select the iOS device name displayed in the pairing list.
  5. Select "YES."
    - Displays "\*\*\* Connecting..."
    - ( "\*\*\* " is the Bluetooth name of the iOS device.)
- ① On the PAIRING/CONNECT screen, "⚡" is displayed on the data device icon.

