

ZZRX-40

A Simple Direct Conversion Receiver for 40 meters

By Craig Johnson, AAØZZ

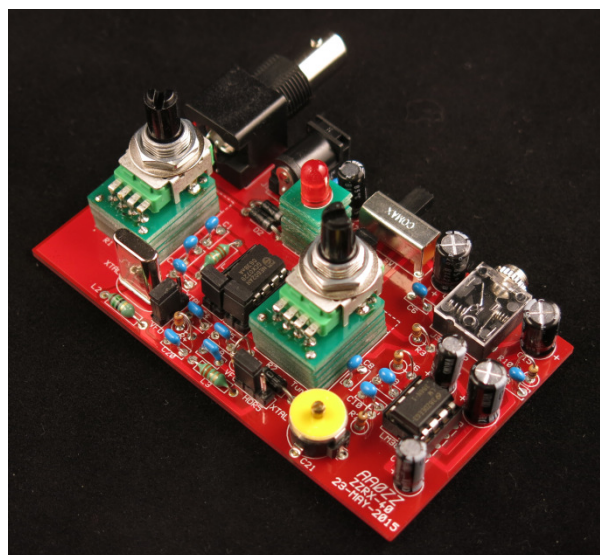

TABLE OF CONTENTS

1	Introduction	2
2	Features.....	2
3	Components.....	2
4	Building the PC Board.....	2
4.1	Local Oscillator Option: User Supplied External Oscillator / Signal Generator.....	10
5	Building the Enclosure	10
6	Installing the PC Board in the Enclosure	16
7	Using the ZZRX-40.....	17
8	ZZRX-40 Theory of Operation	18
8.1	Introduction	18
8.2	Block Diagram.....	19
8.3	Front End Filter	19
8.4	Mixer	19
8.5	Local Oscillator	20
8.5.1	Crystal Controlled	20
8.5.2	Variable Frequency Oscillator (VFO).....	20
8.5.3	User Supplied External VFO or Signal Generator	20
8.6	Amplifier	21
	Appendix A – ZZRX-40 PC Board Schematic	22
	Appendix B – ZZRX-40 PC Board Parts Placement.....	23
	Appendix C – ZZRX-40 Parts List.....	24

1 Introduction

This project demonstrates how a very few components can be assembled to make a functional, usable HF receiver.

2 Features

The ZZRX-40 is a Direct Conversion receiver. This means the local oscillator frequency is at the same frequency (offset by a few hundred Hz) as the RF input signal being selected to hear. Audio is produced directly from the mixer and then amplified so it can be heard in the headphones.

One vertically mounted variable resistor (potentiometer) controls the input RF signal level (volume control) and another variable resistor controls the tuning. If the crystal option is used the tuning pot will “pull” the crystal about 1-2 kHz to each side of the crystal’s frequency.

The input power can come from an external power supply (9 – 12 volts) or from a 4-pack of 1.5v batteries. If a battery pack is used the positive and negative wires are soldered to a header on the board and the power bypasses the on-board regulator. This guarantees that the voltage to the ZZRX circuitry is sufficient. If batteries (6v nominal) are applied to jack J1, the regulator will drop it down by about 1.7v so that’s getting to be too low for good ZZRX operation.

When an antenna is connected and the crystal is installed for the 40-meter CW band, you will most likely hear several stations – especially during evening/night hours. If several stations are transmitting within a few kHz of the crystal frequency you may hear ALL of them at once – at slightly different tones so they can still be distinguished by ear. This is the nature of this ZZRX receiver with very little audio bandpass filtering. That’s for another day. If you are using the crystal for the 40-meter SSB band, nearby stations may interfere with the one you are trying to listen to.

3 Components

See Appendix C.

4 Building the PC Board

Figure 4.1 shows the bare PC board.

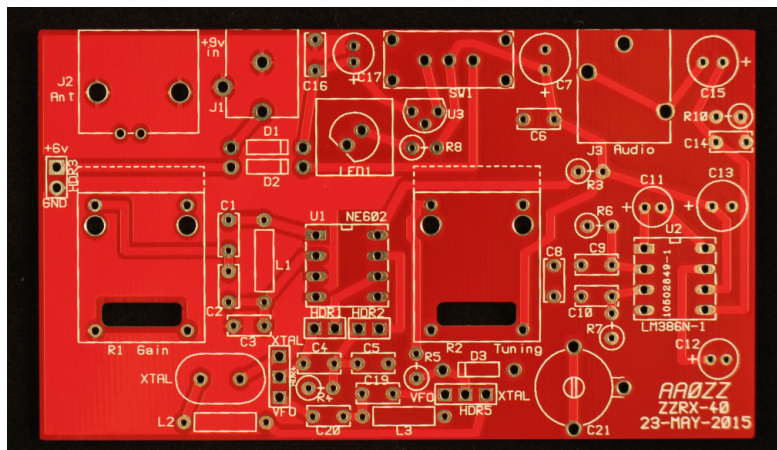

Figure 4.1 - Bare Board – Top Side

Resistors in this kit are installed vertically. Bend over one lead of the resistor next to the body. Insert the straight lead from the body into the hole in the PCB that is marked with the circle and the bent lead into the hole next to it as indicated. More detail follows.

Inductors are mounted flat on the board.

Diodes are mounted flat on the board. (Observe polarity!)

Soldering is done on the bottom side of the board except in a couple of special instances that will be noted.

___ Install the 8-pin DIP sockets for U1 and U2. Make sure the socket is oriented with the notched end “up”, as shown on the silkscreen. Make sure all pins are all the way down in the board by first soldering one corner pin and then reheating this pin while pressing down on the PCB right around the socket. Often you will hear a “snap” as the pins all seat themselves all the way. Verify the socket is mounted with the notch end oriented correctly and then solder the remaining 7 pins.

___ Install the 2-pin headers HDR1 and HDR2. These are located just below U1. The shorter ends of the pins go into the PCB. In each case, solder one connection, then turn over and make sure it's straight. If not, hold the board sideways and heat the soldered connection as you straighten it. Then solder the other pin. Repeat for the other header.

___ Install shorting shunts on the 2-pin headers HDR1 and HDR2.

___ Install the 3-pin headers HDR4 and HDR5. These are also located below U1. The shorter ends of the pins go into the PCB. In each case, solder one connection, then turn over and make sure it's straight. If not, hold the board sideways and heat the soldered connection as you straighten it. Then solder the other pins. Repeat for the other header.

___ Install shorting shunts on headers HDR4 and HDR5. For the crystal-controlled oscillator option install the jumpers between the pins marked as XTAL and the center pins. To use the VFO option, install the jumpers between the pins marked as VFO and the center pins.

___ Install the power input jack (J1) on the PC board. Solder one pin of the jack first. Make sure the jack is flat against the board by holding firm against the board while you reheat that connection pin. Then solder the other connection pins.

___ Install U3, the 78L06 voltage regulator. Be sure to orient the flat surface of the regulator as shown on the silkscreen. The body of the regulator should be about 3/16” above the board when mounted.

___ Install the slide switch (J1) on the PC board with the activating lever pointing outward. Make sure the four corner legs and three switch pins are inserted in the board as far as they can go before soldering.

___ Install capacitors C16 and C6 (0.1u, small, blue, "104K") Solder.

___ Install electrolytic capacitor C7 (100u). Make sure the positive lead of the capacitor is in the hole closest to the “+” on the silkscreen.

___ Install electrolytic capacitor C17 (4.7u). Make sure the positive lead of the capacitor is in the hole closest to the “+” on the silkscreen.

___ Install resistor R3 (10 ohm, brown-black-black-gold). Bend the one lead of the resistor over and down along the resistor body as shown in Figure 4.2. Insert the straight lead to the resistor body in the hole that has the circle around it. The other leg that was bent over goes in the adjacent hole. Solder.

(Note: ALL resistors in this kit are bent and installed in this manner.)

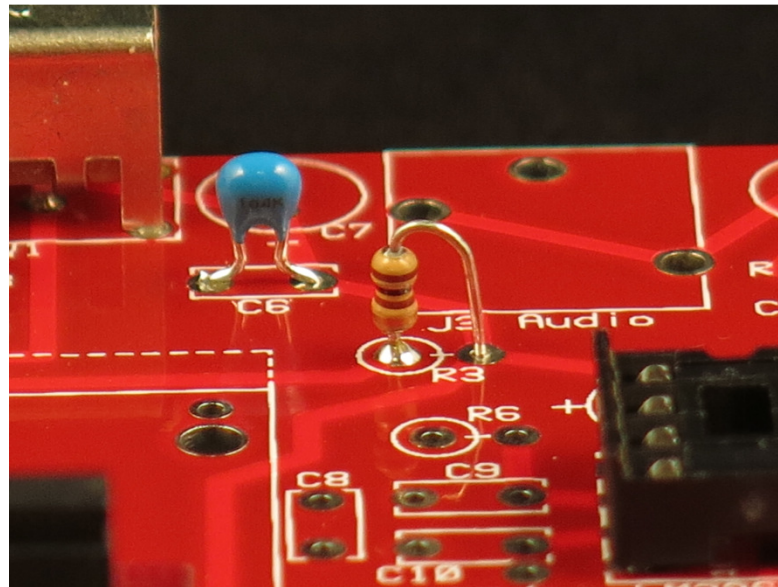

Figure 4.2 – Resistor Installation – Vertical

___ Install resistor R8 (1k ohms, brown-black-red-gold).

___ Install diodes D1 and D2 (Schottky, 1N5817). Make sure you have the correct diodes and have them oriented with the banded end as indicated on the silkscreen. Solder.

___ There are 8 LED shims, shown in Figure 4.3. Ensure that they are all facing upward (white silkscreening up) and that the pictures all show the LED flat spots in the same direction. Locate the flat spot on the plastic base of the LED. This is also the shorter LED lead – signifying the negative (cathode) side. Insert the LED leads through the shim with the shorter lead going into the hole which is nearest the flat spot on the silkscreen. Thread the other 7 shims on the LED leads, making sure the shims are aligned in the same way as the top shim. Then extend the leads through the LED holes of the board. Again, align the shim LED flat spots with the silkscreen picture on the board. Before you solder the leads to the board on the bottom side, line up the shims in a neat stack (for cosmetic purposes only). Makes a nice light pole, right?

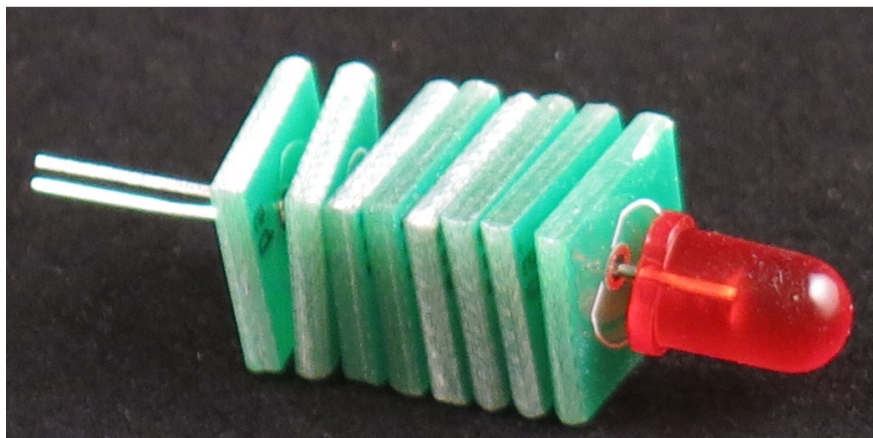

Figure 4.3 – Stacks of 8 Shims on LED

Now it's time for a power check – to make sure the power input to the ZZR_X is working properly.

If you are using the power supply or battery option, apply 9 - 13v to the input power jack (J1) and use a voltmeter to make sure you are getting around 5.9 - 6v on pin 8 of the DIP socket U1 and on pin 6 of DIP socket U2. A convenient ground connection for your DVM is the ground pin of HDR3 (the battery connection header). Move the lever of the slide switch TOWARD the power jack. The LED should light when power is applied.

If you are using the 4-cell battery option, connect the wires of the battery pack to HDR3. Make sure you connect the red wire to the "+" terminal and the black wire to the GND terminal. Use a voltmeter to make sure you are getting around 5.9 – 6.6v on pin 8 of the DIP socket U1 and on pin 6 of DIP socket U2 (see Figure 4.4). A convenient ground connection for your DVM is the ground pin of HDR3 (the battery connection header). Move the lever of the slide switch AWAY from the power jack. The LED should light when battery power is applied.

If the LED does not light and the voltage on the two DIP socket pins is nowhere near 5.9 – 6v, check for bad or unsoldered solder joints or solder bridges. If you get the correct voltage but the LED is not on, check the orientation of the LED. Only proceed when you have the power supply and LED working properly.

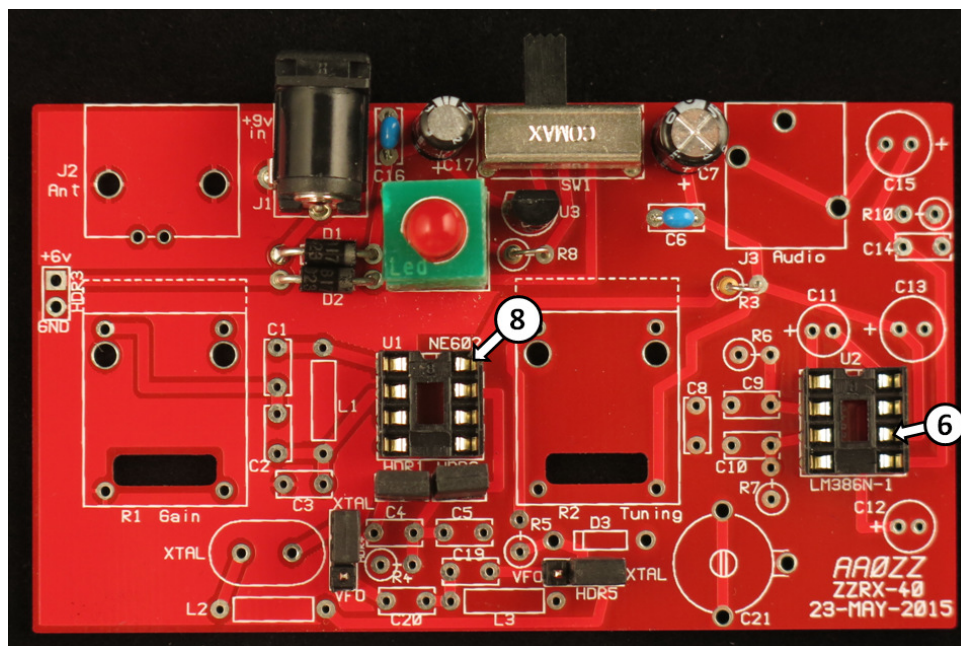

Figure 4.4 – Power Supply Complete

Ready to go on?

___ Install J3, the stereo jack. Solder one pin of the jack first. Make sure the jack is flat on the board by holding the board sideways and pressing down on the jack as you reheat the soldered connection. Then solder the other pins.

___ Install capacitor C1 (180p, small, blue, "181"), located just to the left of the 8-pin DIP socket for U1. Solder.

___ Install capacitor C2 (820p, small, blue, "821"). Solder.

___ Install capacitors C3, C8, C14 (0.1u, small, blue, "104K"). Solder.

___ Install capacitor C4 and C5 (100p, small, blue, "101J"), located just below the 8-pin DIP socket for U1. Solder.

___ Install capacitors C9 and C10 (0.22u, small, blue, "224"), located just to the right of the 8-pin DIP socket for U1. Solder.

___ Install electrolytic capacitors C13 and C15 (100u). Make sure the longer (positive) leads goes in the side marked with the "+". Solder.

___ Install electrolytic capacitor C11 (4.7u). Make sure the longer (positive) lead goes in the side marked with the "+". Solder.

___ Install electrolytic capacitor C12 (2.2u). Make sure the longer (positive) lead goes in the side marked with the "+". Solder.

___ Install resistor R4 (1M ohm, brown-black-green-gold). Bend the one lead and install as before. Solder.

___ Install resistor R5 (100k ohm, brown-black-yellow-gold). Bend the one lead and install as before. Solder.

___ Install resistors R6 and R7 (10k ohm, brown-black-orange-gold), located between the 8-pin DIP sockets for U1 and U2. Bend the one lead and install as before. Solder.

___ Install resistor R10 (10 ohm, brown-black-black-gold). Bend the one lead and install as before. Solder.

___ Install inductor L1 (3.3uH, green body, orange-orange-gold-gold). This inductor lies flat on the board when installed. Solder.

___ Install diode D3 (1N4004). Make sure you have the correct diode and have it oriented with the banded end as indicated on the silkscreen. Solder.

___ Prepare eight 3/4" (or longer) lengths of wire. Scrap resistor leads are fine and are about the right gauge. Bend them as shown in Fig 4.5.



Figure 4.5 – Scrap Wire

There are the 12 pot shims, shown in Figure 4.6. They will be installed in two stacks of 6.

___ Look at the picture of Figure 4.6. Make two stacks of 6 shims. **Make sure ALL of the shims have the white silkscreened word "Shim" facing up and the row of 4 holes is near the bottom.** Insert one wire through the top left corner of one of the shims, then through the same

corner of the second, third and fourth shims, and finally through the corresponding hole in the PCB. Look at the picture in Figure 4.6 and make sure you have it in the correct location. The row of four holes is toward the bottom of the shims and positioned above the rectangular cutout on the PCB on the bottom.

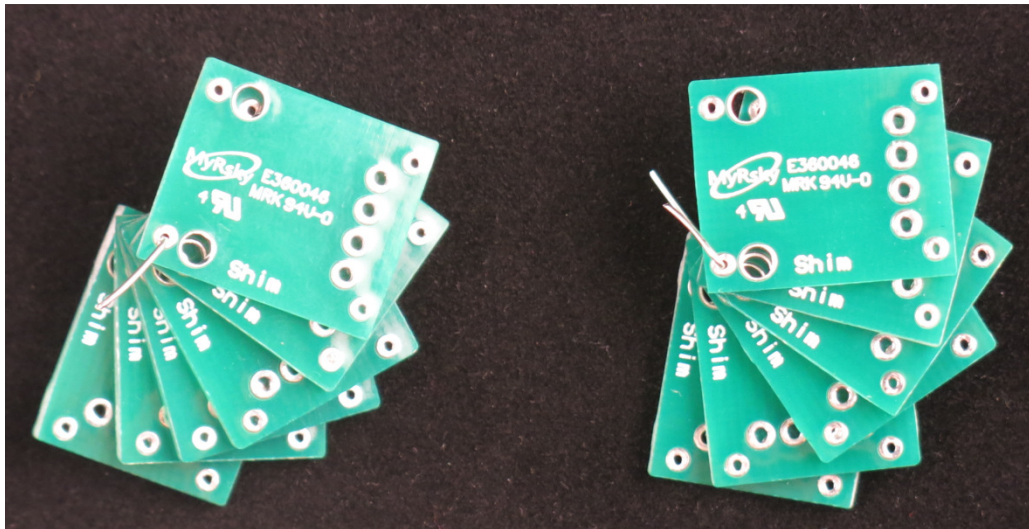

Figure 4.6 –Two Stacks of 6 Shims

___ After verifying again that you are have the shims oriented correctly on the PCB and the first wire placed, put three more wire scraps through the other three shim corner holes and corresponding PCB holes. The board should look like Figure 4.7.

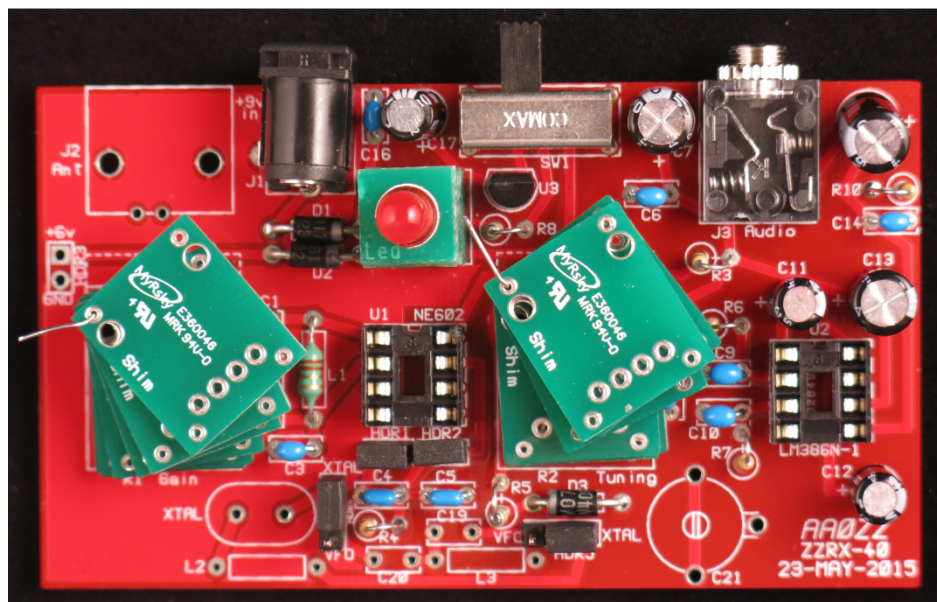

Figure 4.7 – Wires in Four Corners – Not Soldered Yet

___ Turn board over and solder all four wires coming through the corner holes (Fig 4.8). Trim.

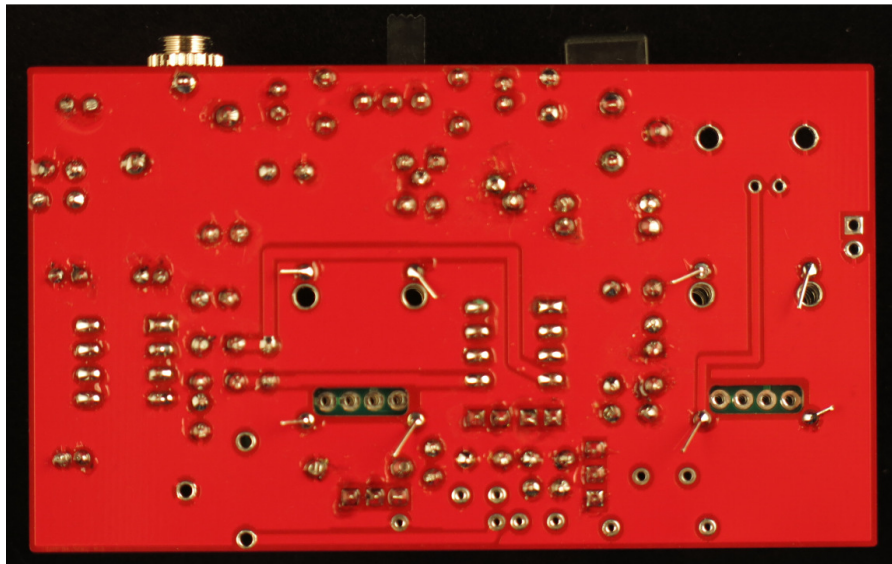

Figure 4.8 – Four Corner Wires on Back Side - Soldered

___ Turn board back to front side. **Make sure the shims are all FLAT on the board** and solder all four wires coming through the corner holes (Fig 4.7). **Use a SMALL amount of solder on these connections so you can trim them closely to ensure the solder connection does not contact the frame of the pot when it is installed later.**

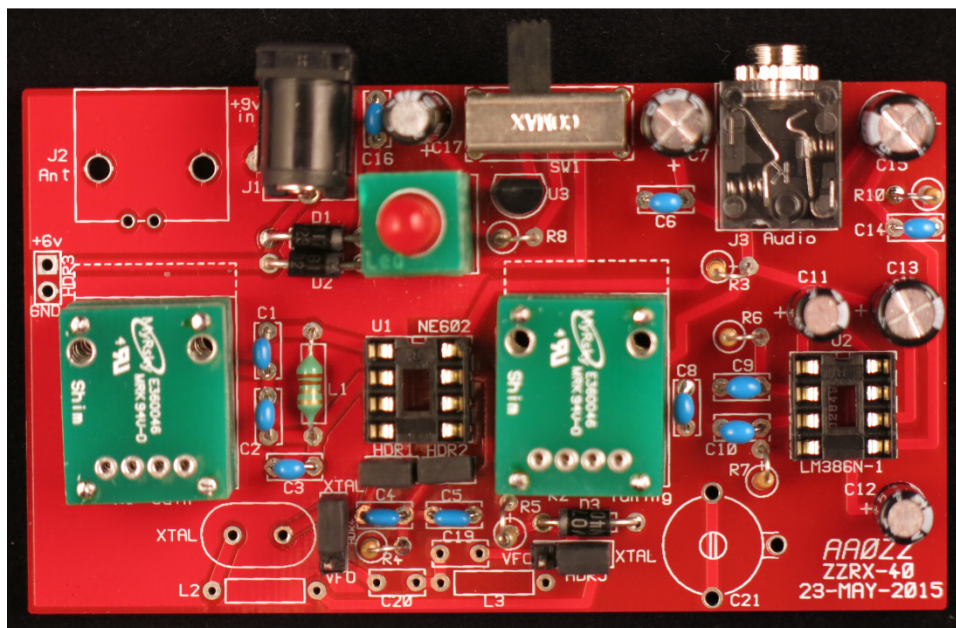

Figure 4.9 – Four Corner Wires on Front Side - Soldered

___ Install J2, the antenna BNC jack. Solder.

___ Install variable resistors R1 and R2 (10k). These pots have a little unusual format in that they have four pins instead of the more common three. Instead of one pin for each end and one for the wiper, this pot has a fourth pin which is a dummy and not used. With the shaft pointing upward and the pins facing you, the dummy is the pin on the far right. (The shim shorts the dummy pin to the pin next to it.)

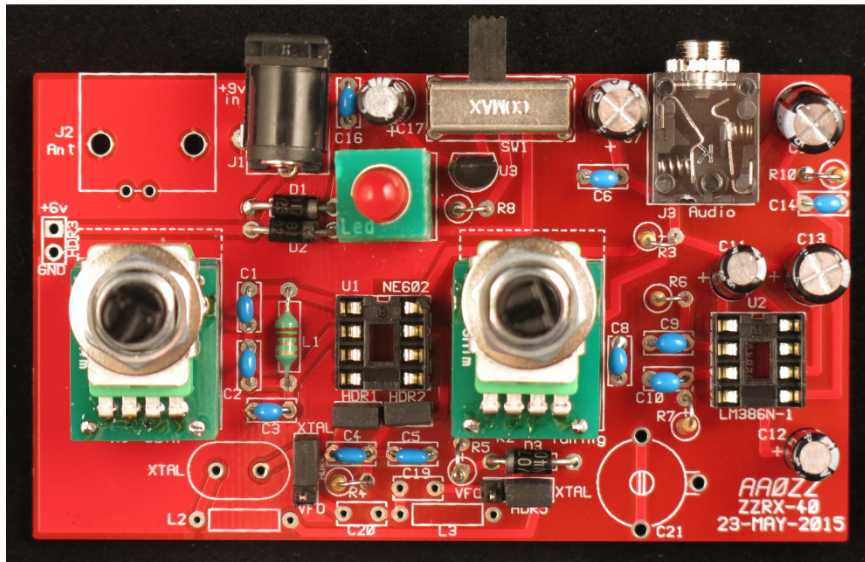

Figure 4.10 – Pots Installed

Make sure the four pot pins are inserted correctly and the two mounting tabs are inserted all the way. You may want to insert the 4 pins first and rotate back on the mounting pins. Pressing from the side with a small screwdriver helps get these mounting pins to go in straight. When all pins are fully inserted, check to make sure the corner pins of the shim do not contact the frame of the pot. **If necessary, remove the pot and trim the solder of the shim wire before reinstalling the pot.** Make sure the pot is firmly down and resting on the shim before soldering the 4 pot pins to the shim pads. Then solder the two mounting pins to the shim pads.

___ Install trimmer capacitor, C21. Solder. See Section 5.5.2 for the C21 adjustment procedure to be performed after the receiver assembly is complete.

___ Install Crystal, XTAL. Keep it up about 1/16" off the board to prevent shorting. Solder.

___ Install inductor L2 (15 uH. green body, brown-green-black-gold). This inductor lies flat on the board when installed. Solder.

___ Install capacitor C19 and C20 (100p, small, blue, "101J"). Bend the leads outward so they are parallel to the board and about 1/8" from it.

___ Install inductor L3 (4.7 uH, green body, yellow-violet-gold-gold)

___ Install U1, the NE602, in its socket. Be sure you correctly identify U1 and U2. You won't like what happens (smoke) if you get them wrong! Orient the notch per the silk-screen on board and the notch in the socket. To prepare the NE602 for installation, hold it by the two ends, turn it on its side and press down on a table top so all 4 pins on that side are bent in a bit - until they are pointing straight down. Turn the NE602 over and do the same with the other 4 pins. Now both sets of pins should be aligned so it will insert easily into the socket.

___ Install U2, the LM386, in its socket in the same manner as was used for installing U1.

4.1 Local Oscillator Option: User Supplied External Oscillator / Signal Generator

The ZZR-40 board is set up to allow the easy connection of a user-supplied Local Oscillator. HDR1 and HDR2 have jumpers which can be removed to disconnect the on-board crystal oscillator / VFO. Then you can connect an external oscillator to the “right side” pin of HDR2 which goes to pin 7 of the NE602. No connection is made to Pin 6. Go ahead and experiment with an oscillator / signal generators of your choice.

That’s it! The ZZR-40 is ready to use.

5 Building the Enclosure

There are different methods that can be used to build the enclosure. Read through these suggested approaches and see what makes most sense to you. Details of each approach follow.

Approach 1: Assemble the enclosure without soldering until all pieces are in place. Hold together with tape on the corners or with a few rubber bands around it. Then solder all four edges and four corners.

Approach 2: Assemble and tack solder one edge at a time. After all four edges are tacked on and aligned, add additional solder tack points. Solder all edges.

Here is what the enclosure looks like at first.

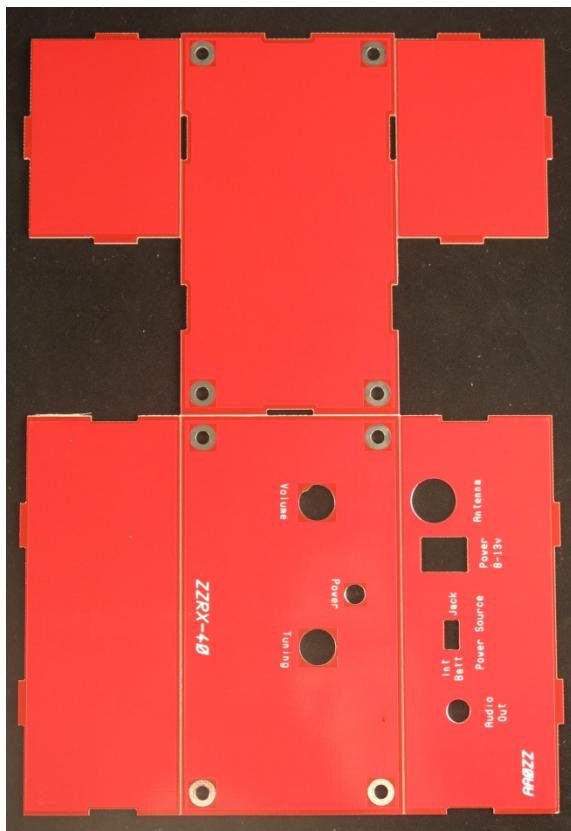

Figure 5.1 – Enclosure Outside

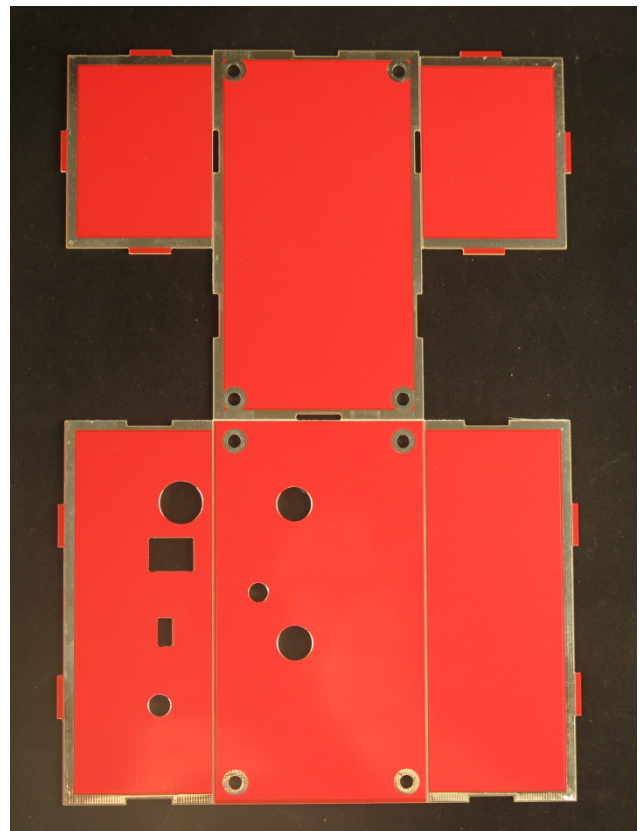

Figure 5.2 – Enclosure Inside

___ Break apart the 6 pieces. Figure 5.3

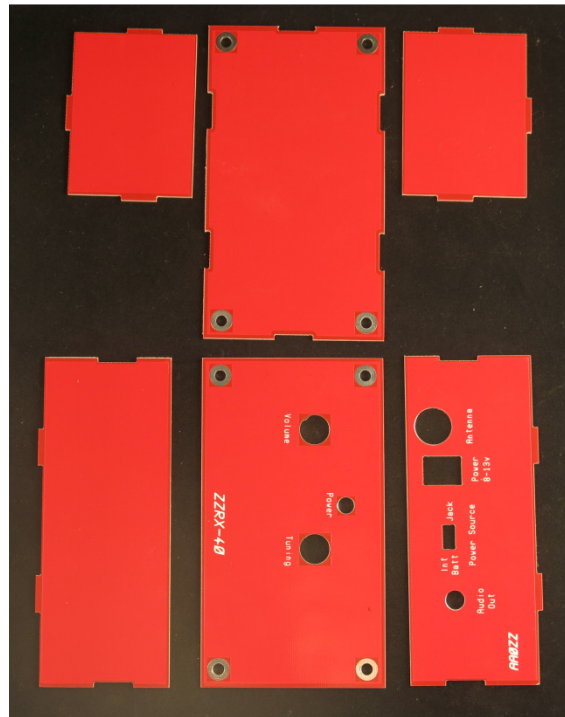

Figure 5.3 – Enclosure Broken Apart

___ Sand or file all of the edges. You will be happy that you took the time to do this since it feels much better when in use. Use a fine-tooth mill file (Figure 5.4) or a sanding block. You could put a piece of sandpaper on the workbench and hold the piece vertically as you run it back and forth over the sandpaper. Be very careful not to mar any of the soldermask surfaces!



Figure 5.4 – Mill File

Method 1:

___ Assemble the enclosure - four edge pieces and the bottom - and hold it together with tape on the four corners (Figure 5.5a). Alternatively, you could secure it with several rubber bands (Figure 5.5b). Then solder the edge joints.

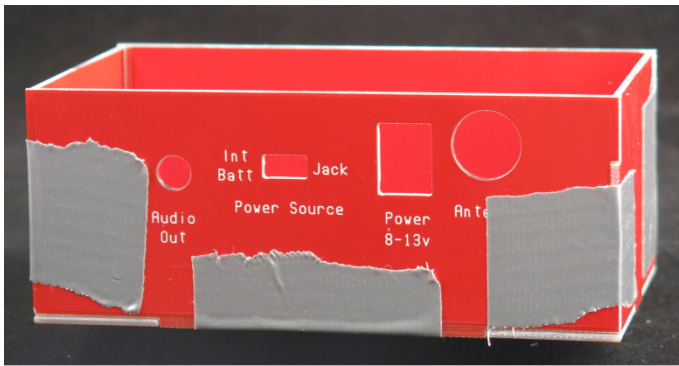

Figure 5.5a –Sides Taped in Position

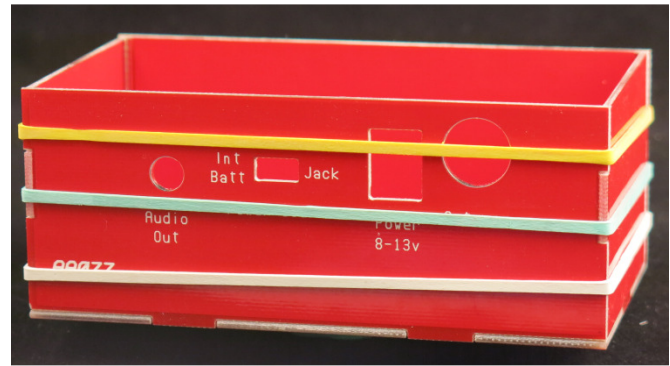

Figure 5.5b –Sides Held with Rubber Bands

___ Tack solder the edges to the bottom board in several places on each edge. As you solder, heat both boards of the edge simultaneously with a blunt-tipped soldering iron. Low wattage is sufficient.

___ Tack solder the corners together in several places each. Add solder to joints after all pieces are in place. You can solder along the entire edges but it is not necessary. You may find it easier to do this by standing the box upright on an edge with the corner to be soldered on the bottom.

Method 2:

___ Place a small solder “blob” next to each of the notches of the long edges of the bottom board. Pacing the solder near the notches instead of in the larger solder areas guarantees the two boards to be flush when soldered. A low-wattage, blunt-tipped soldering iron is sufficient. See Figure 5.6.

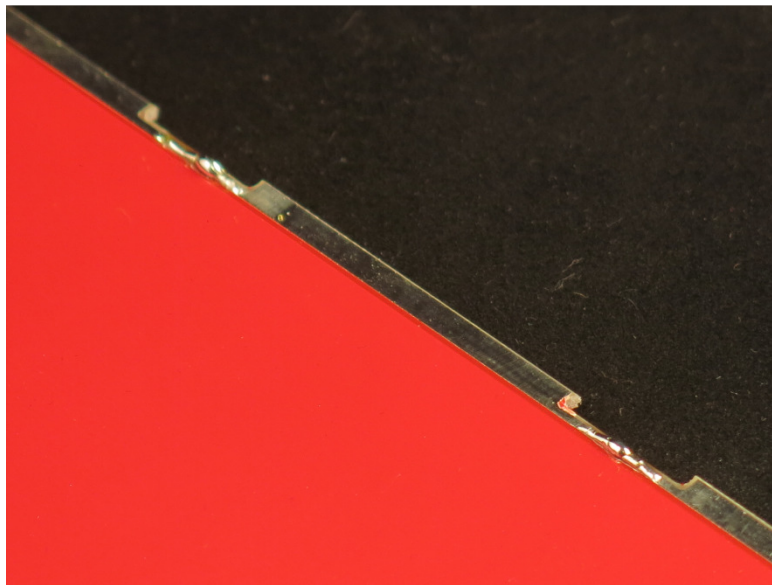

Figure 5.6 – Solder “Blobs” on First Edge

___ Tack the edge of the side piece to the bottom board. As you solder, heat both edges simultaneously with the blunt-tipped soldering iron. See Figure 5.7.



Figure 5.7 – First Side Attached

___ In a similar manner, tack the other side to the bottom board. See Figure 5.8.



Figure 5.8 – Second Side Attached

___ Now tack the end piece to the bottom board. See Figure 5.9.



Figure 5.9 – Three Sides

___ Now tack the other end piece to the bottom board. See figure 5.10.

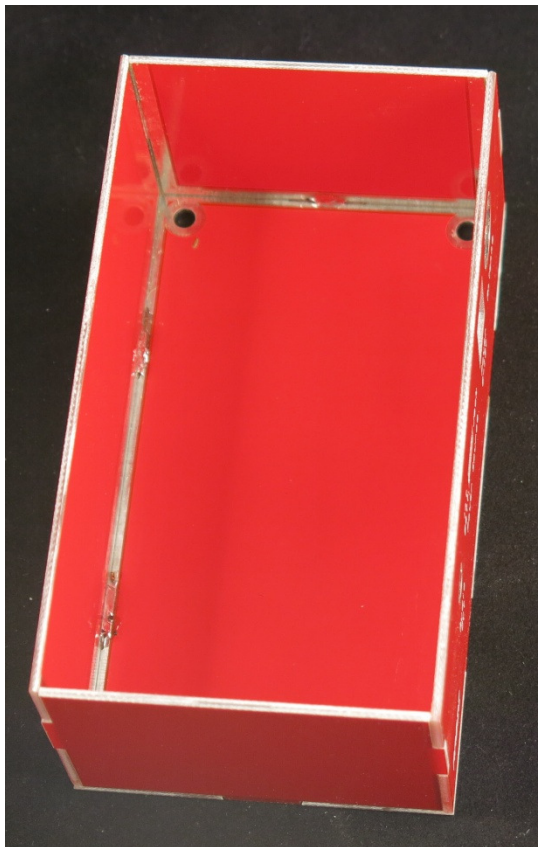

Figure 5.10 – All Sides

___ When all edges are tacked in place and all fit properly, add additional solder to various places along the edges (Figure 5.11). You don't have to solder the entire edges but there is no harm if

you want to. You may find it easier to do this by standing the box upright with the corner to be soldered flat on the table.

___ In a similar manner, solder the vertical edges of the four corners (Figure 5.11).

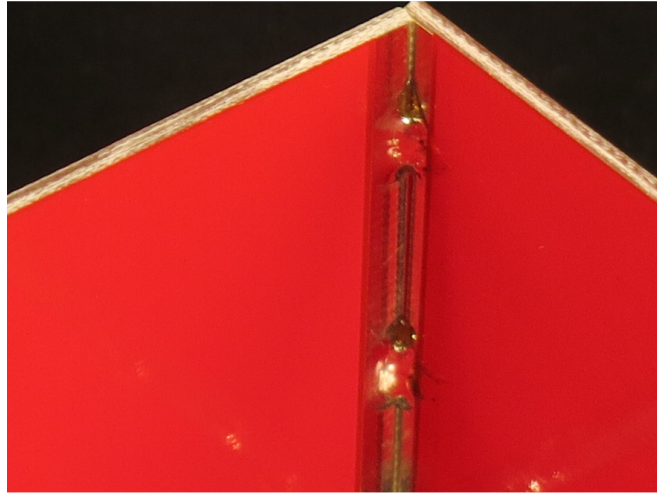

Figure 5.11 –Solder On Vertical Edges

___ Now add solder to all edges. You do not need to solder the entire edges but you may if you want to. (Figure 5.12).

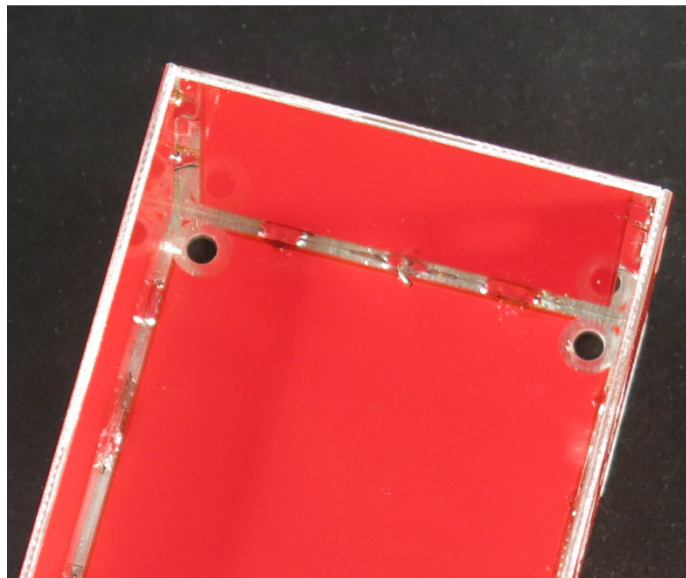

Figure 5.12 – Additional Solder On Edges

___ Install the four 1.75" spacers in the inside corners of the enclosure. For each spacer use a 3/8" screw through a rubber bumper and then through the enclosure bottom and into the spacer. See Figure 5.10.

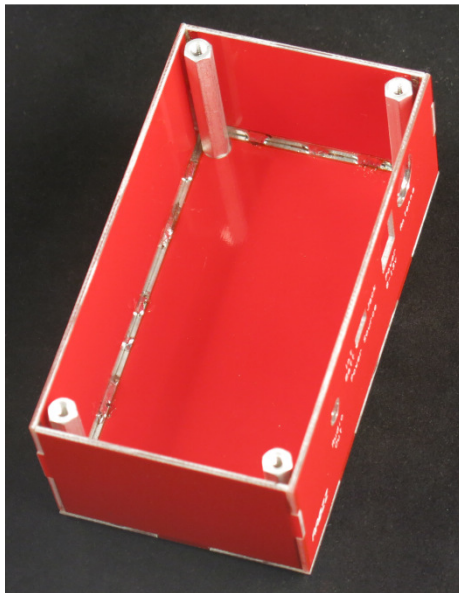

Figure 5.12 – Corner Spacers

6 Installing the PC Board in the Enclosure

___ Install a battery pack with four AA batteries. (Example: Digikey BC4AAW-ND)

___ Attach the 4-cell AA battery pack to the PCB at HDR3. Solder the red wire to the positive (+) terminal and the black wire to the other ground (-) terminal. **WATCH THE POLARITY!**

___ Remove the nuts and washers from the BNC jack and the nut from the audio jack. Also remove the nuts and washers from the gain and tuning pots. Insert the two jacks through the holes at the side of the enclosure. Add the washer to the BNC jack and install both nuts. Be careful not to scratch the enclosure as you tighten the nuts.



Figure 6.1 – Board Mounted in Enclosure

- ___ Place the top cover over the two pots and LED. (Figure 6.2).
- ___ Install the washers and nuts to hold the top cover on but leave loose.
- ___ Attach the cover with 3/8" screws into the four corner spacers. Tighten.
- ___ Tighten the nuts on the two pots, taking care not to scratch the surface.
- ___ Install the knobs on the volume and tuning pot shafts.



Figure 6.2 – Cover Installed

That's it! The ZZR receiver is ready to use.

7 Using the ZZR-40

Apply 9 -13 volts from a battery or power supply to J1 or connect a 4-cell battery pack (~6v) to HDR3. Connect an antenna to J2 and headphones to J3.

Turn R1 to maximum volume (clockwise) and, if you are using crystal-controlled VFO, you should hear signals immediately. Turn the tuning pot R2 to pull the crystal frequency a few kHz on each side of its nominal frequency.

If you are using the variable frequency VFO, advance the tuning knob about 1/3 of the way up (clockwise) from minimum. This should be approximately 7.0 MHz. Tuning is very sensitive but you should be able to receive CW, SSB and AM signals.

As you tune in CW signals in a DC (direct conversion) receiver such as this, the sound will be equally strong on the lower and upper sides of center (zero beat). It may sound strange if you are accustomed to listening to CW signals with one sideband suppressed as they usually are in modern receivers. This is done to minimize interference from near-by stations. Many direct conversion receivers such as this ZZR receiver do not have circuitry to suppress one sideband or the other so you hear them both. There really isn't a convention for which side to listen to for CW stations and some suppressed-sideband receivers use the lower side of zero beat and some use the upper side. (Some of these CW receivers allow you to change from one side to the other. They

usually refer the two sides as CW and CW-Reverse but the convention as to which is which is up to the manufacturer.) For CW signals in the ZZR_X, listening to either side of zero beat is possible and both will be nearly the same volume. If one side or the other gets interference from a nearby station you can just move a little and listen to the other side. Aren't DC receivers wonderful?

As you tune in SSB signals with the ZZR_X, they will be also equally strong on the LSB as USB sides. Again, it may sound strange if you are accustomed to listening to SSB signals on a receiver that suppresses one sideband. Since the ZZR_X receiver is a direct conversion receiver and it doesn't have circuitry to suppress one of the sidebands, you hear both of them. Suppressing one side or the other is done in the receiver to minimize interference from close-by stations. A SSB transmitter only transmits one of the sidebands for efficiency reasons, but the opposite side gets restored by the detector and local oscillator in the receiver. By convention (not actually an FCC requirement), SSB stations on the 40-meter band use LSB for voice transmission. Many modern receivers, when set to receive the correct-by-convention sideband, only allow the correct, intelligible sideband through the filters and you may not even know the other side is there. With this DC receiver, as you advance upward in frequency you will hear the SSB stations start high in tone and go lower. As you continue to advance the frequency the tones of the SSB station reach a low point and then start to get higher again. The first side you heard (lowest frequency) was the UPPER sideband and the second side (higher frequency) is the LOWER sideband. (I know, again this is counter-intuitive but technically correct.) In the 40-meter band, because of the convention, you will find the SSB speech to be unintelligible on the USB side and intelligible on the LSB side.

8 ZZR_X-40 Theory of Operation

8.1 Introduction

The ZZR_X-40 receiver doesn't break any new ground but packages together some ideas that have been around since shortly after the NE602 was introduced by Signetics in the 1980's. The pairing of an NE602 and an LM386 has inspired many receiver / transceiver designs, some very simple and some with additional complexities. A very similar receiver is described in detail in Chapter 1 of the book, Experimental Methods in RF Design by Hayward, Campbell and Larkin. You do have "the book", don't you? Highly recommended! There are some component differences between the ZZR_X-40 and the EMRFD receiver but the operation of the two receivers is very similar.

One of my goals for this receiver was to make it as simple as possible and to have it come alive without any component adjustments. This simplicity has its pros and cons. It means the front end filter is very wide, allowing many signals of nearby frequencies to enter the NE602. Many of the similar NE602/LM386 receivers use tuning elements, often a 421F123 transformer, on the front end to narrow it down. There is no doubt that narrowing the front end (i.e., increased selectivity) makes it work somewhat better. However, the simplicity of the no-tune front end of the ZZR_X-40 works so well it is somewhat surprising.

8.2 Block Diagram

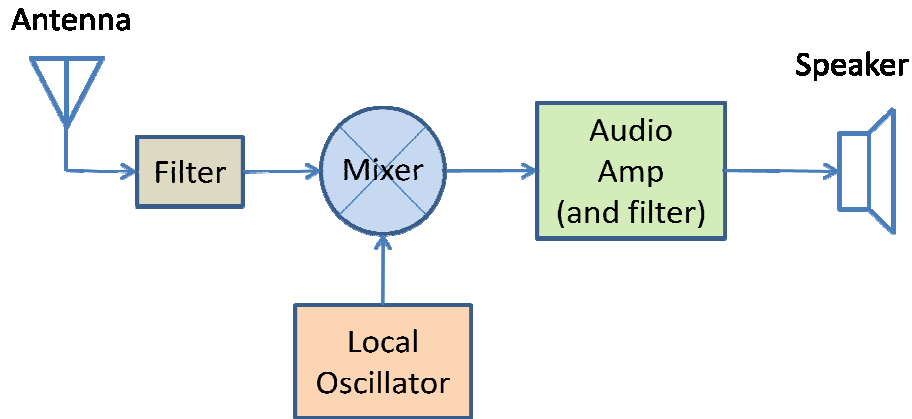

8.3 Front End Filter

The RF signal coming in from the antenna BNC connector goes to a gain control pot, R1, and then to three simple components that function as an RF Bandpass Filter and an impedance transformer.

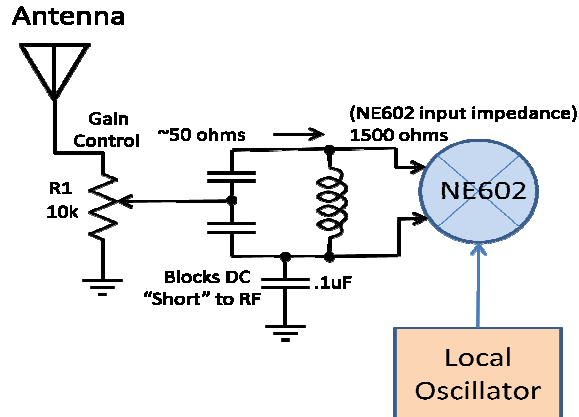

The capacitive-divide circuit transforms two functions:

- 1) It transforms the antenna impedance (~50 ohms) to the NE602 input impedance (1500 ohms)
- 2) It provides a bandpass filter to limit the signals passing through to a desired frequency range.

The bandpass filter was designed with a Q of 10 with a center frequency of 7.0 MHz. A sharper (higher Q) filter could have been used, giving greater selectivity (smaller frequency range), but this design does not require any tuning adjustments to make it work.

8.4 Mixer

The NE602 (or NE612, or SA612) has been the work-horse mixer for simple to moderately complex receivers / transmitters / transceivers since it was introduced in the 1980's. It performs well in many applications; however, it has limitations – mainly regarding its dynamic range. It provides a signal gain of 18 dB (rather than a 7dB loss for typical diode ring mixers) and it has the makings of a local oscillator (crystal-controlled or tuned-tank) and can also be used as a buffer for an external VFO or signal generator. Mixing a Local Oscillator signal with an incoming RF signal of slightly different frequency (e.g. 600 Hz higher) gives an audio tone of 600 Hz.

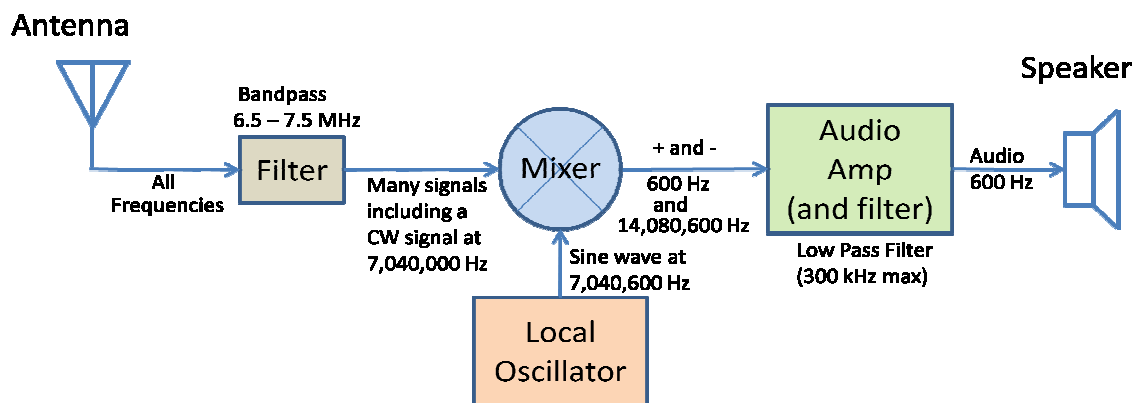

8.5 Local Oscillator

8.5.1 Crystal Controlled

The ZZRX standard configuration is with a crystal-controlled oscillator. The crystal oscillator is configured with a fixed inductor and a 1N4004 diode as a voltage-controlled capacitor (varactor) in series with the crystal. The crystal frequency is varied by a few kHz as the voltage applied to the varactor is varied by turning the knob on tuning pot, R2.

8.5.2 Variable Frequency Oscillator (VFO)

The ZZRX crystal oscillator can be changed into a VFO by changing two jumpers. Now crystal oscillator's series inductor (L2) is replaced with a tank inductor (L3) to resonate with the varactor as the tank capacitor. C20 is also installed to decouple the tank circuit.

Note that this VFO is a very simple VFO made from a few inexpensive components. The use of a 1N4004 varactor as the tuning element automatically means it is limited. Many VFOs use a variable capacitor instead of a varactor and that provides much more control; however, it would add significant cost to the kit. The limited capacitance range of a 1N4004 (approximately 35 pf to 15 pf as the voltage changes from 0.1v to 6v) means tuning is very sensitive. Stray capacitance such as that from a hand nearby affects the frequency too.

A trimmer capacitor, C21, is used to set the lower limit of the 40-meter band. This can be done with a frequency counter connected to the top ("loop") end of resistor R4 or by listening for the ZZRX local oscillator signal in a nearby receiver. The tuning pot, R2, should be turned completely counterclockwise when setting the lower limit.

Here are typical values for the ZZRX receiver with the VFO option:

Frequency Range as R2 changes from min to max	Voltage applied to D3 as R2 changes from min to max
----- 7.000 - 7.384 MHz	----- 0 - 6.00 v

8.5.3 User Supplied External VFO or Signal Generator

The ZZRX receiver has two 2-pin headers (HDR1 and HDR2) that have jumpers across them for standard built-in crystal-controlled oscillator or the simple VFO. If you want to use an alternate

VFO or a signal generator, simply remove both jumpers and inject your VFO signal into the right-hand pin of HDR2 – the one that goes to pin 7 of U1, the NE602.

8.6 Amplifier

The LM386N-1 is configured (with C11 between pins 1 and 8) to provide a gain of 200. The LM386 also provides some filtering in that it blocks anything above 300 kHz. Additional audio filtering is provided by the series combination of C14 and R10.

AA0ZZ ZZRX-40 Receiver
24-AUG-2016

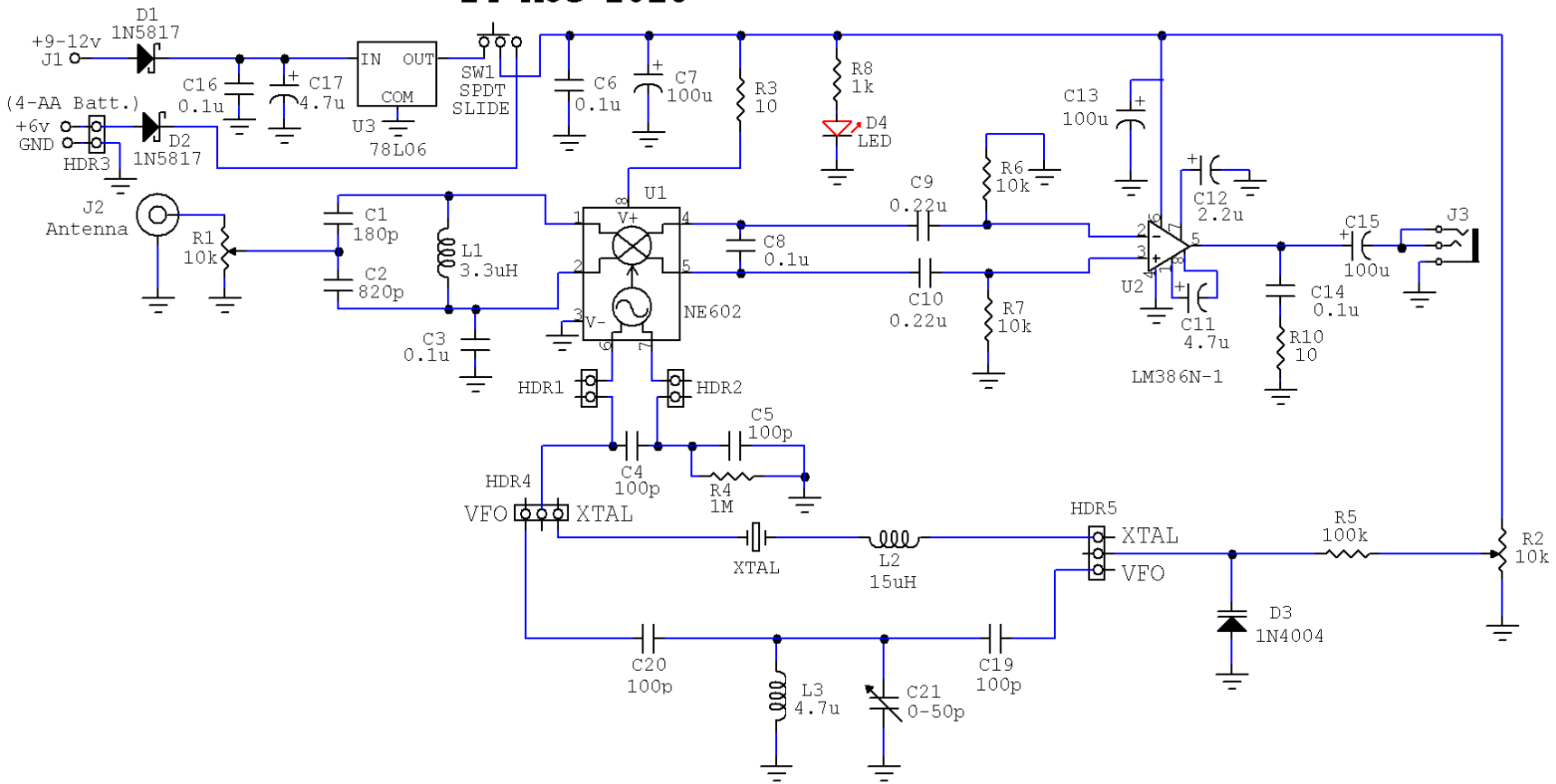

Appendix B – ZZRX-40 PC Board Parts Placement

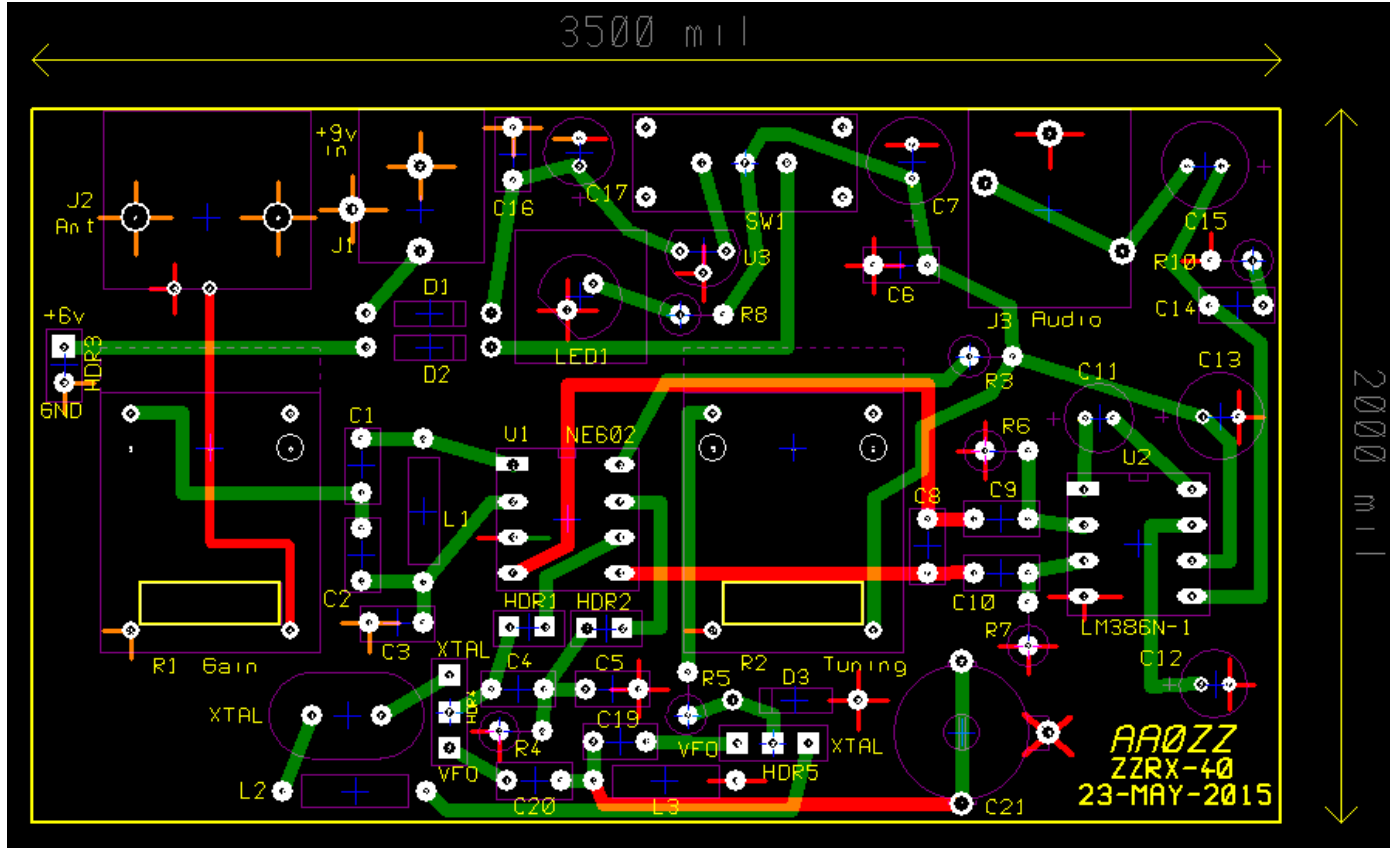

Appendix C – ZZR-40 Parts List

1-JUL-2016

AA0ZZ ZZR-40 Version 8.0a Parts List

Quantity	Designator	Description	(D) DigiKey (M) Mouser or Other
4	C4, C5, C19, C20	Capacitor, 100p, monolithic, radial C0G, (small, blue, "101J") 5% .5mm spacing	(D) 490-8630-ND
1	C1	Capacitor, 180p, monolithic, radial C0G (small, blue, "181J") 5% 5mm spacing	(D) 490-8654-ND
1	C2	Capacitor, 820p, monolithic, radial C0G (small, blue, "821J") 5% 5mm spacing	(D) 490-8720-ND (D) 445-4737-ND
5	C3, C6, C8, C14, C16	Capacitor, 0.1u, monolithic, radial C0G (small, blue, "104K") 10% X7R 5mm spacing	(D) 490-7515-1-ND
2	C9, C10	Capacitor, 0.22u, monolithic, radial X7R (small, blue, "224Z") 10% 5mm spacing	(D) 490-8832-ND
1	C12	Capacitor, 2.2u, electrolytic, 50v 20% 2mm spacing	(D) 493-1100-ND
2	C11, C17	Capacitor, 4.7u, electrolytic, 50v 2mm spacing	(D) P996-ND
3	C7, C13, C15	Capacitor, 100u, electrolytic, 25v 2.5mm spacing	(D) 493-1061-ND
1	C21	Capacitor, Trimmer 4.5-65PF top adjust	(D) SG3009-ND
2	R1, R2	Potentiometer, 10K ohm, vertical mount, linear	(D) 987-1289-ND
2	R3, R10	Resistor, 10 ohm, 1/6w, 5% (brown-black-black-gold)	(D) 10EBK-ND
1	R8	Resistor, 1k ohm, 1/6w, 5% (brown-black-red-gold)	(D) 1.0KEBK-ND
2	R6, R7	Resistor, 10k ohm, 1/6w, 5% (brown-black-orange-gold)	(D) 10KEBK-ND
1	R4	Resistor, 1M ohm, 1/4w, 5% (brown-black-green-gold)	(D) CF14JT1M00CT-ND
1	R5	Resistor, 100k ohm, 1/6w, 5% (brown-black-yellow-gold)	(D) 100KEBK-ND
1	L1	Inductor, 3.3 uH, molded, 5% (green body) (orange-orange-gold-gold)	(D) 78F3R3J-RC-ND
1	L3	Inductor, 4.7 uH, molded, 5% (green body) (yellow-violet-gold-gold)	(D) M10143-ND
1	L2	Inductor, 15 uH, molded, 5% (green body) (brown-green-black-gold)	(M) 542-78F150J-RC
2	D1, D2	Diode, 1N5817, Schottky	(D) 1N5817FSC-ND
1	D3	Diode, 1N4004	(D) 1N4004DICT-ND
1	D4	LED, Red, T-1 3/4	(D) 67-1110-ND
1	J3	Jack, Audio, 1/8", stereo	(D) CP1-3513-ND
1	J1	Jack, coaxial, power, 5.0 / 2.1 mm	(D) CP-102AH-ND
1	J2	Jack, BNC, PCB mount	(D) A97553-ND
1	For J2	Lock washer for BNC jack	(D) A97567-ND
1	For J2	Hex nut for BNC jack	(D) A97566-ND

2	For U1, U2	Socket, DIP, 8-position	(D) ED3044-5-ND
2	HDR1, HDR2	Header, 0.1", 1x2 pos'n	(D) WM9823-ND
2	HDR4, HDR5	Header, 0.1", 1x3 pos'n	(D) WM50014-03-ND
4	For HDR1, HDR2, HDR4, HDR5	Shunt, 0.1"	(D) S9000-ND
1	U1	NE602 IC DIP8	(KitsAndParts.com)
1	U2	LM386-1 IC DIP8	(D) LM386N-1/NOPB-ND
1	U3	Regulator, voltage, 6v, 78L06, TO-92	(D) 497-1010-ND
2	For R1, R2	Knob, 1/2" diameter, 1/4" shaft	Jameco 265122 or equivalent
1	SW1	Switch, Slide, SPDT, RA	(D) CKN10393-ND
12	For R1, R2	Shim, Pot	AA0ZZ supplied
8	For LED	Shim, LED	AA0ZZ supplied
1	XTAL	Crystal HC49/U, 7.031 MHz	(KitsAndParts.com)
1	PCB	PCB, ZZR-40	AA0ZZ supplied
1	Enclosure	AA0ZZ Custom Enclosure and hardware	AA0ZZ supplied