

# AR5000 BLOCK DIAGRAM

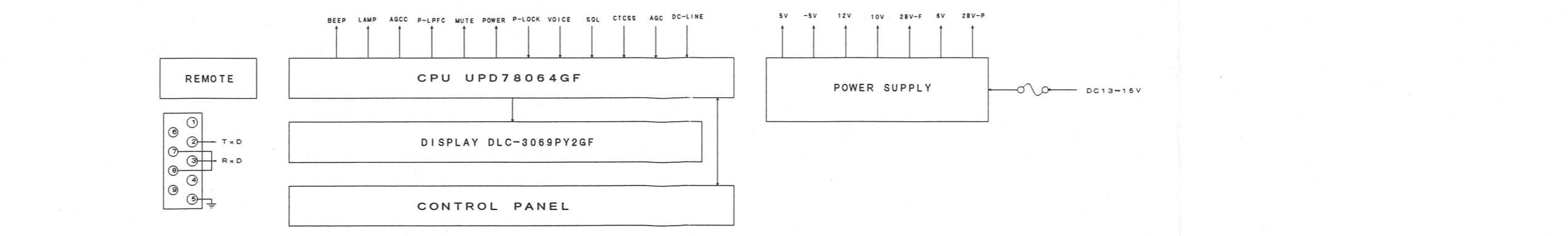

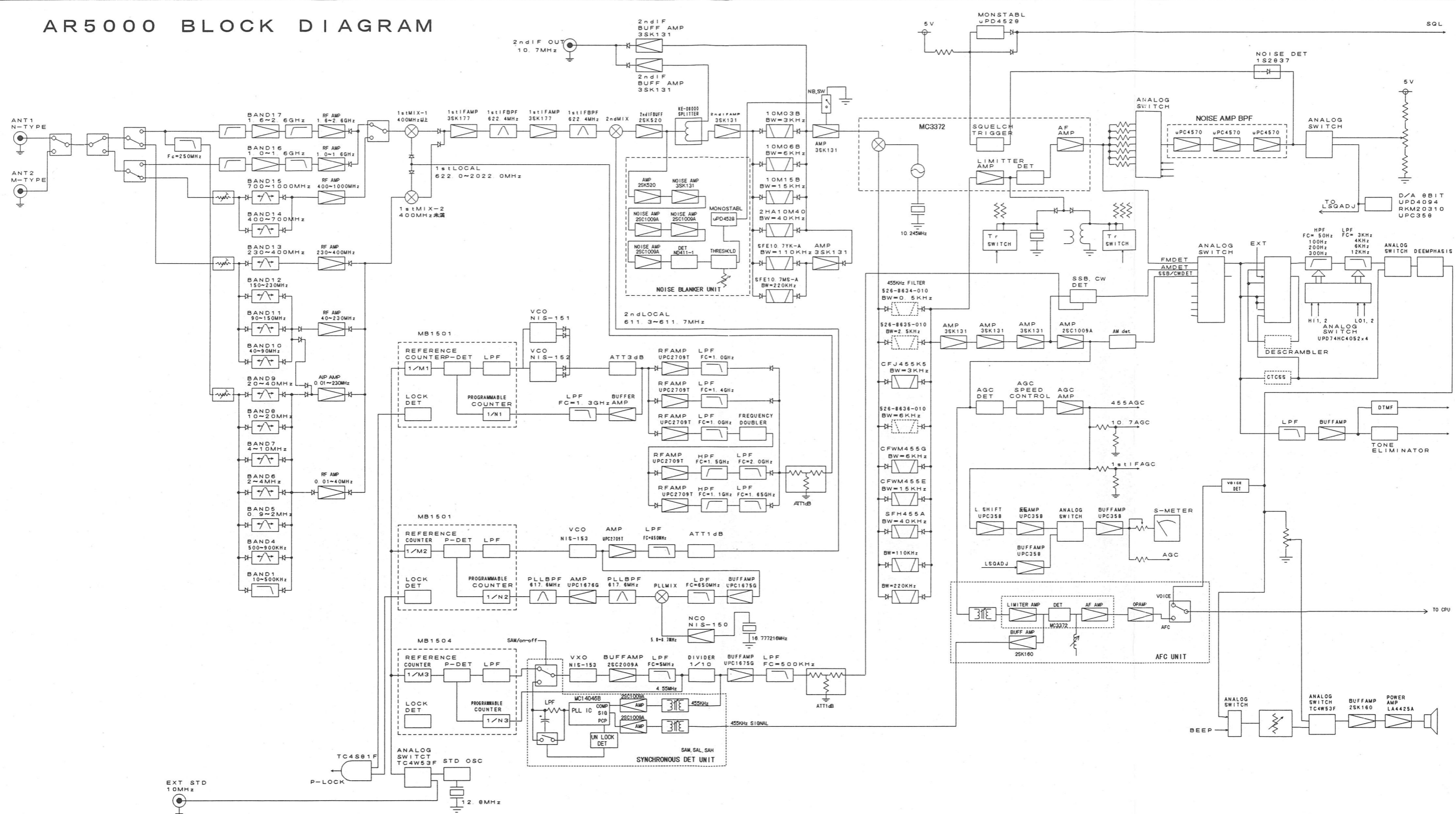

| Title ARK_RFINIT |                    |          | AOR Ltd |          |
|------------------|--------------------|----------|---------|----------|
| Size             | Number             | Revision | Date    | Drawn    |
| 3180X4500        | 1                  | 4        | 1993.06 | Tsuyoshi |
| File             | D:\WORK\ARK_RFINIT |          | Sheet   | 1 of 1   |

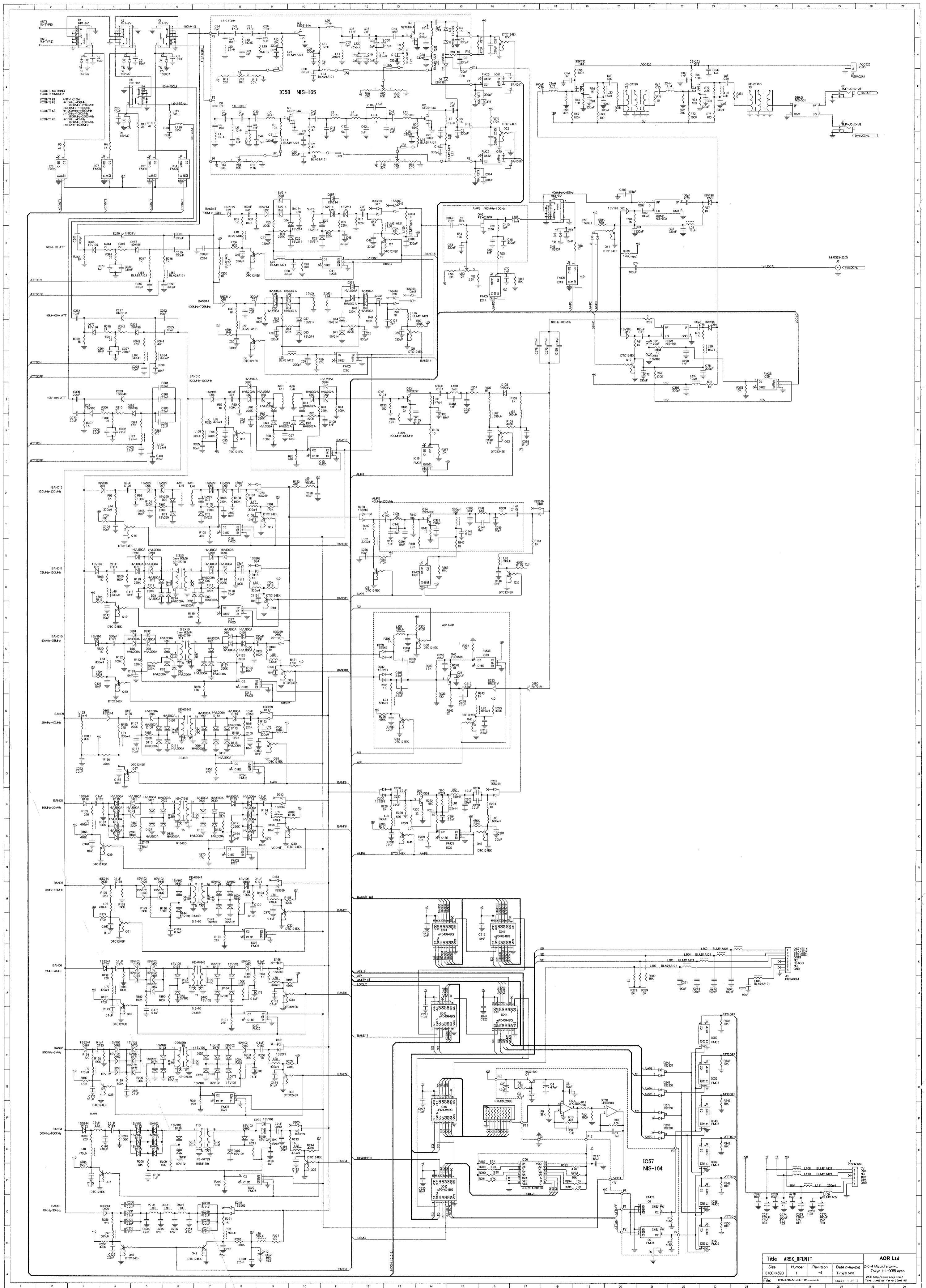
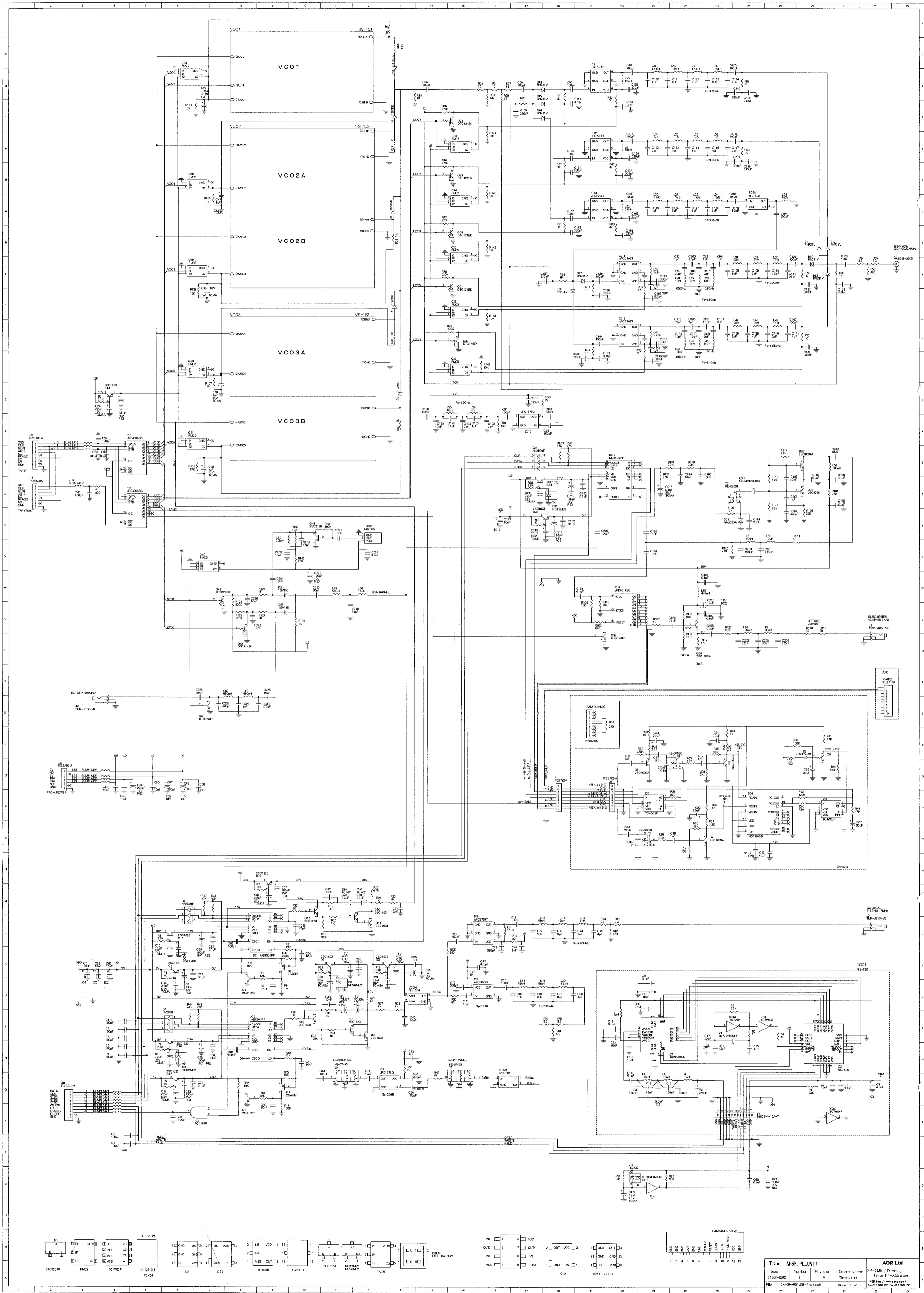

|                    |                               |          |            |            |            |
|--------------------|-------------------------------|----------|------------|------------|------------|
| Title ARSK_PLLUNIT |                               |          |            | AOR Ltd    |            |
| Size               | Number                        | Revision | Date       | Drawn      | Checked    |
| 3180X4550          | 1                             | 4        | 2011-11-13 | Y. Teraoka | Y. Teraoka |
| File               | D:\WORK\ARSK\PCB\ARSK_PLLUNIT |          | Sheet      | 1 of 1     |            |

(REV)





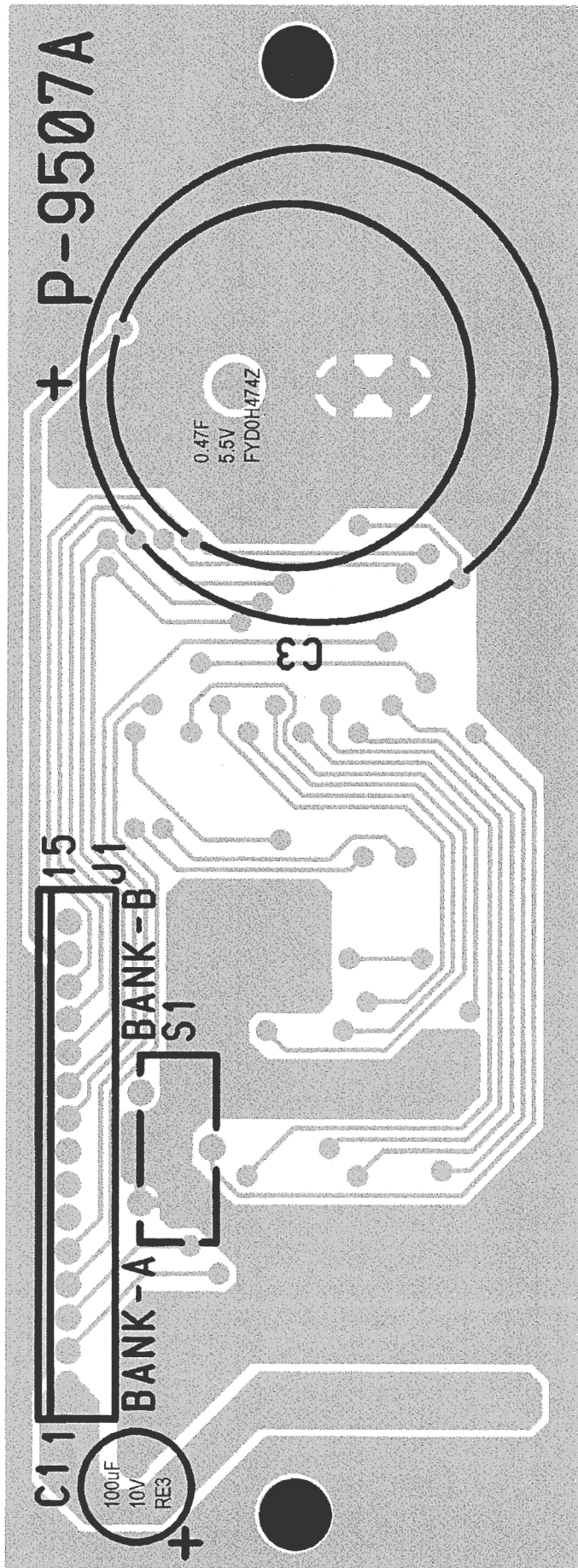

AR5K CPU SUB COMPONENT SIDE

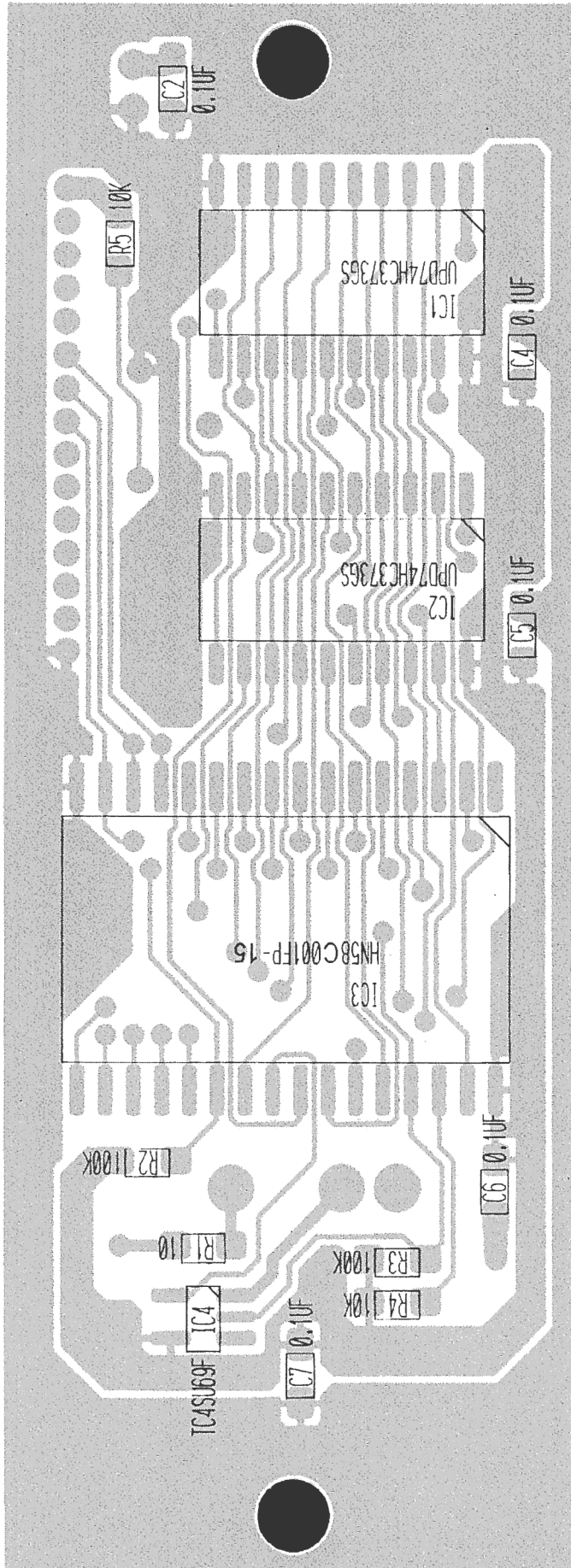

AR5K CPU SUB SOLDER SIDE

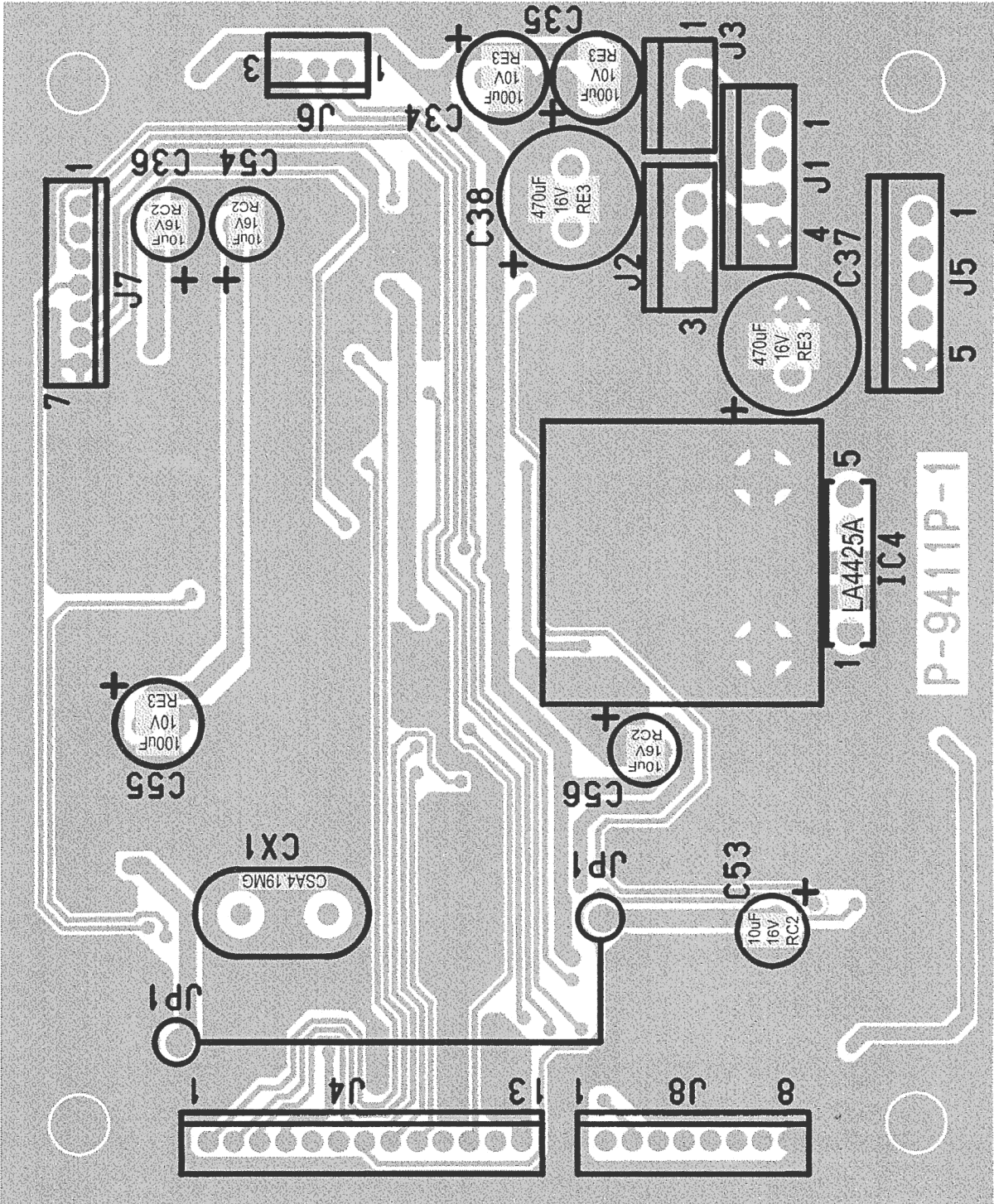

AR5K AFUNIT COMPONENT SIDE



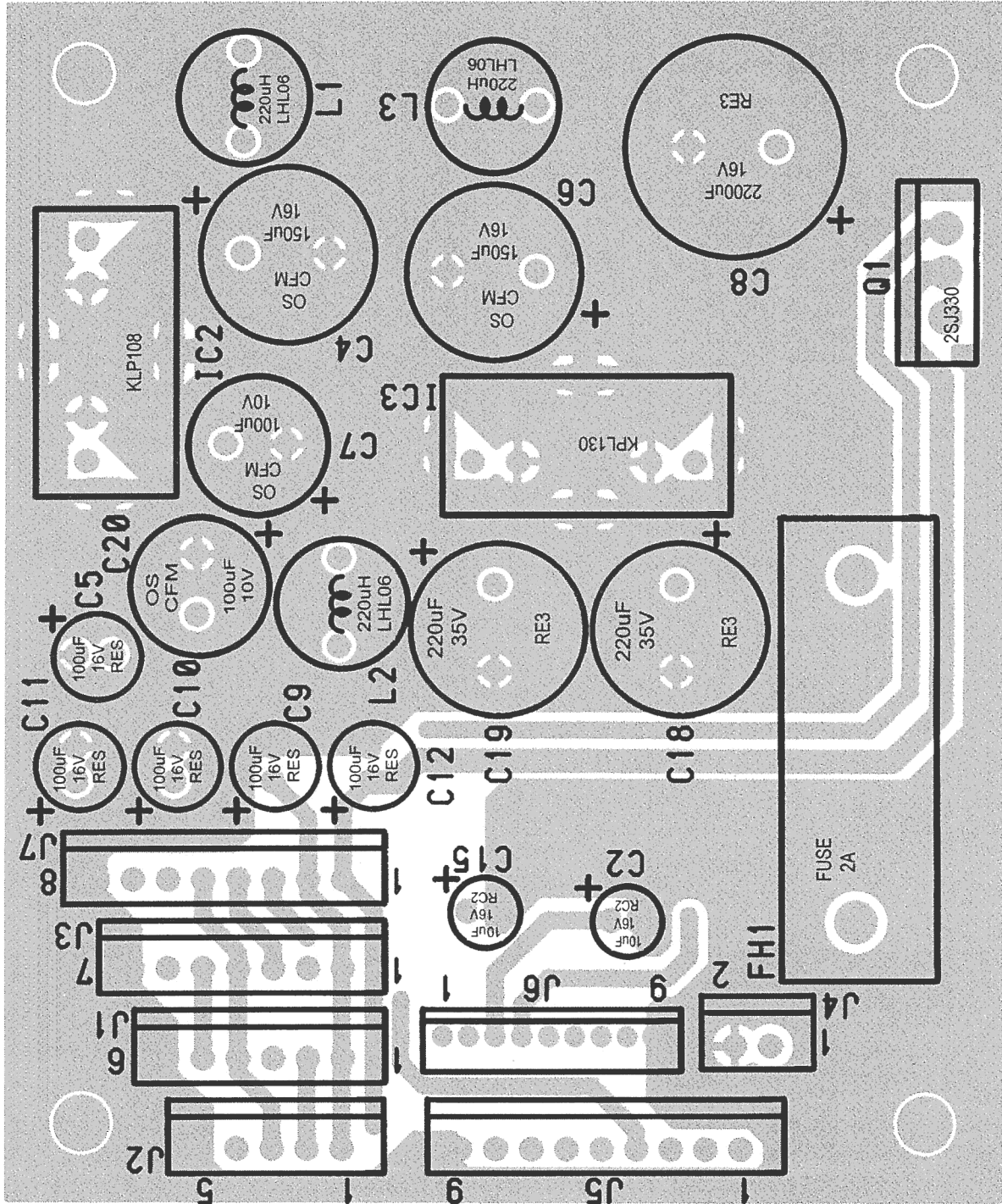

AR5K POWER UNIT COMPONENT SIDE

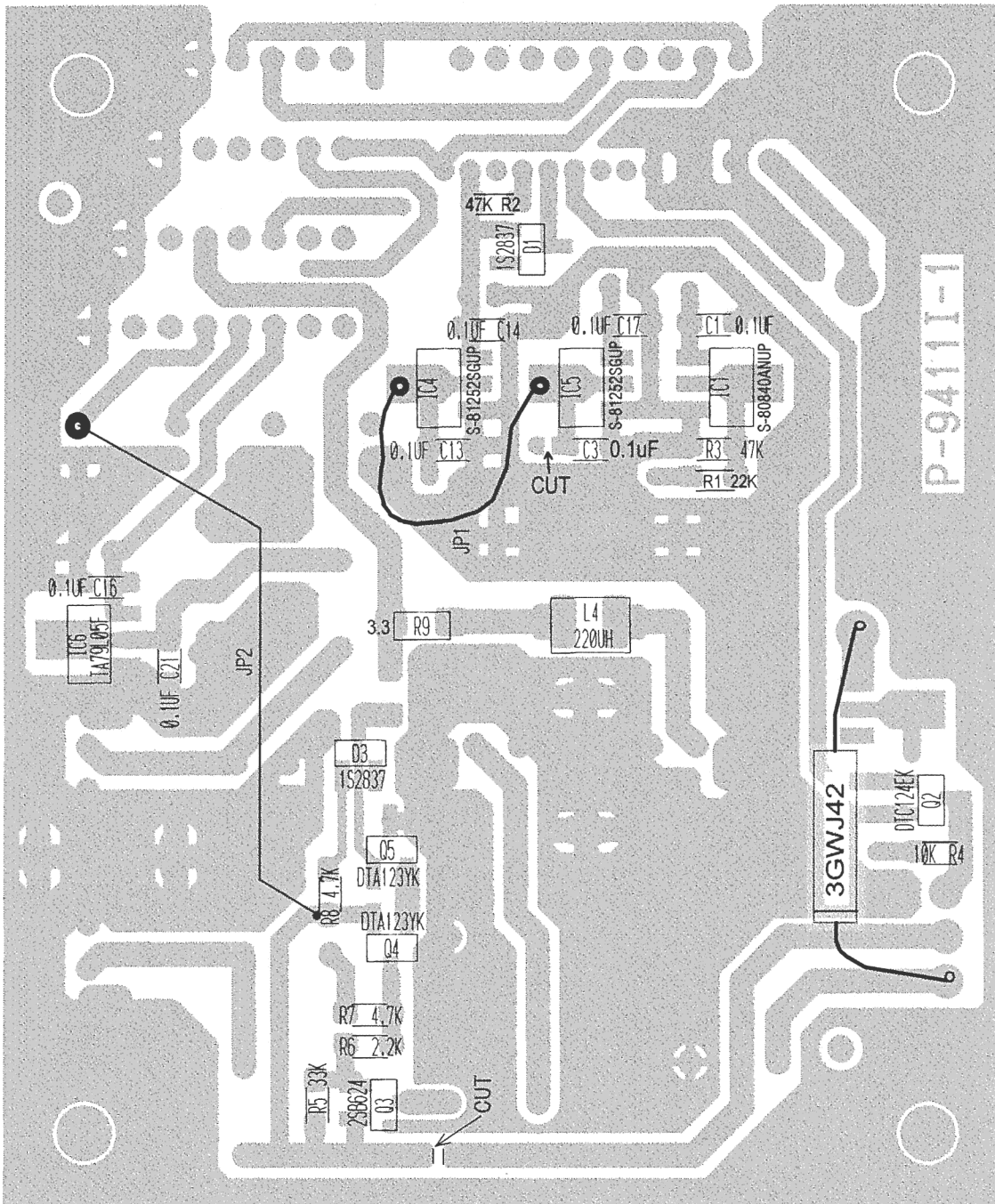

AR5K POWER UNIT SOLDER SIDE

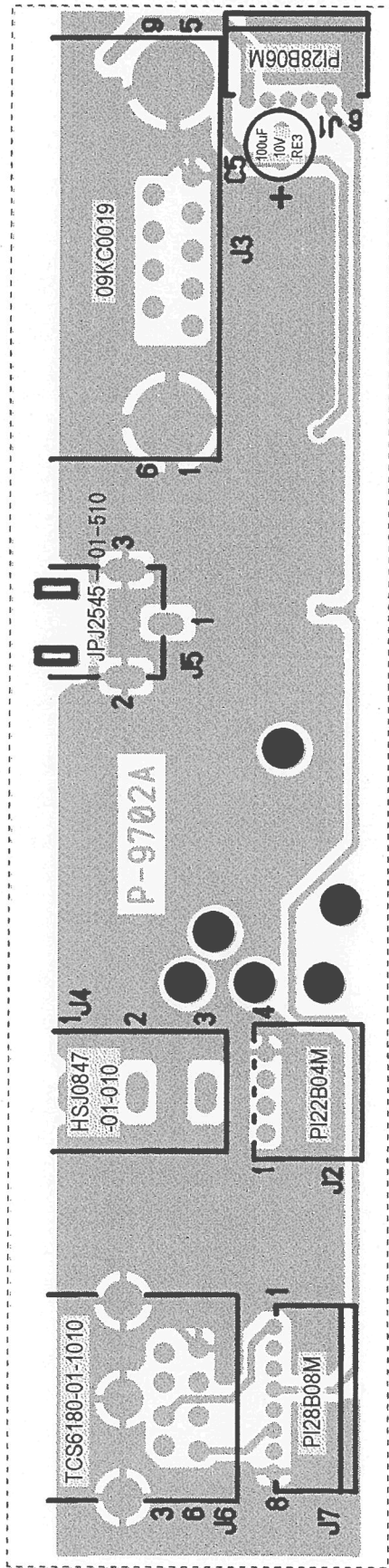

AR5K REMOTE UNIT COMPONENT SIDE

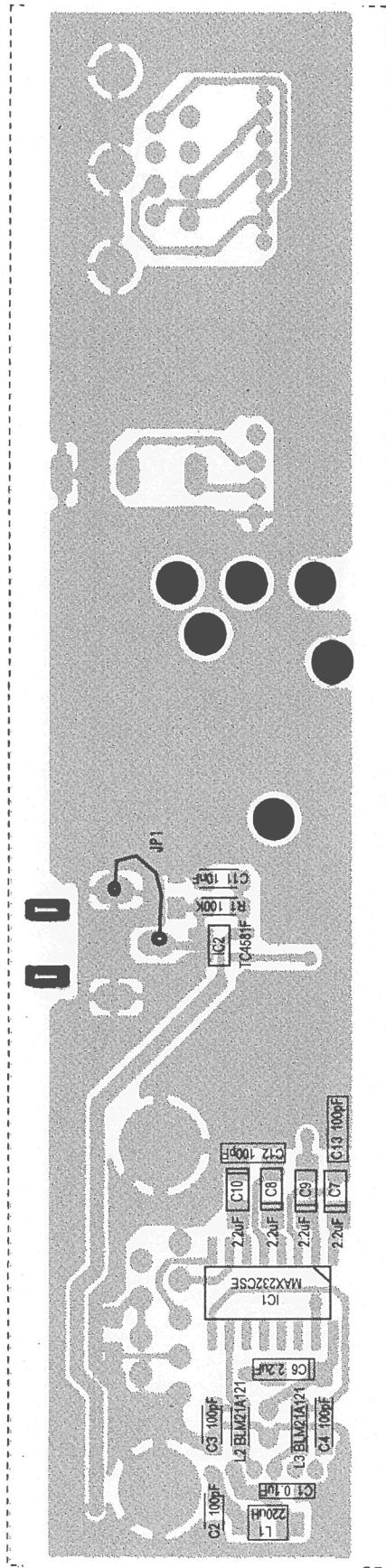

AR5K REMOTE UNIT SOLDER SIDE

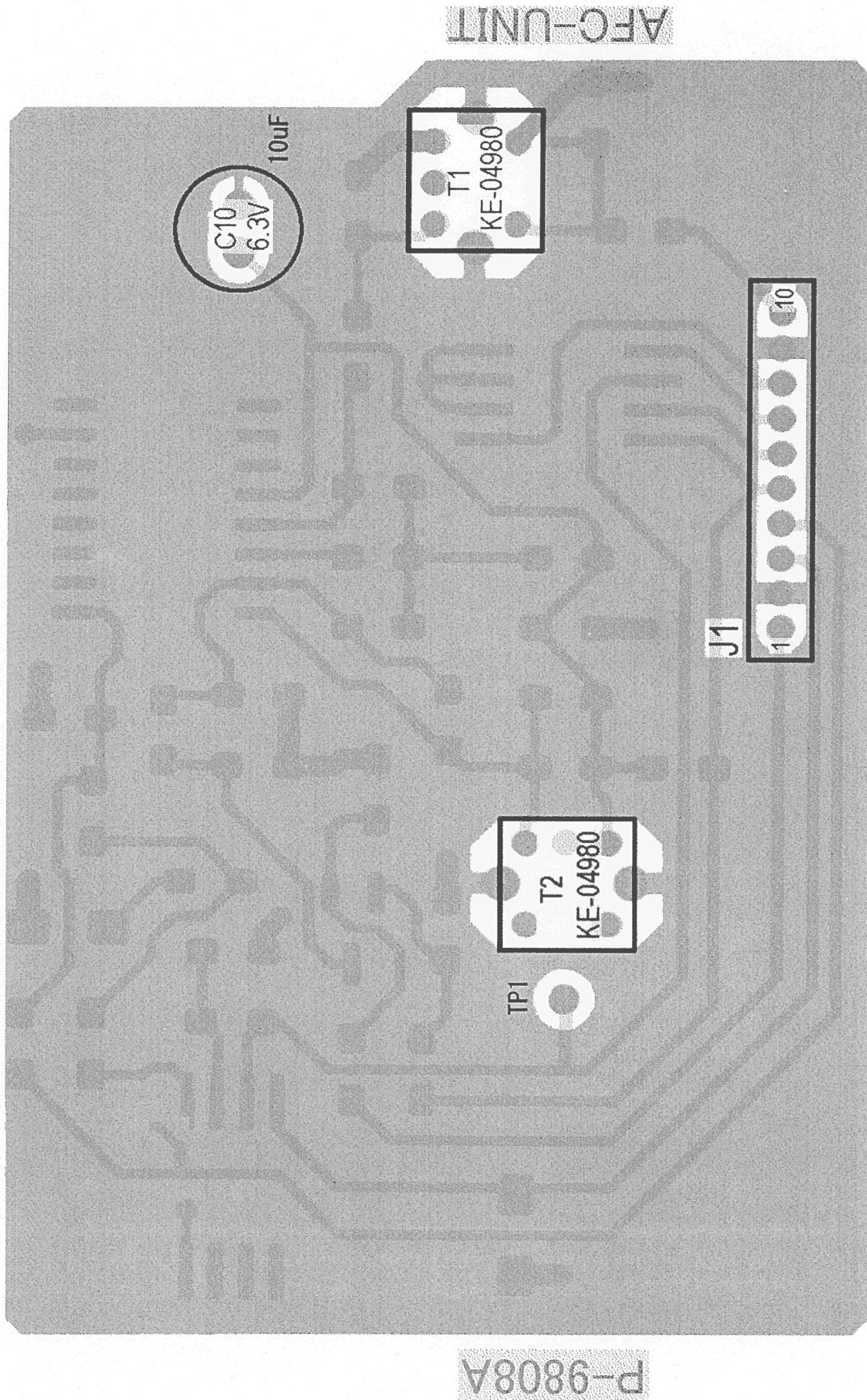

AR5K AFC UNIT COMPONENT SIDE

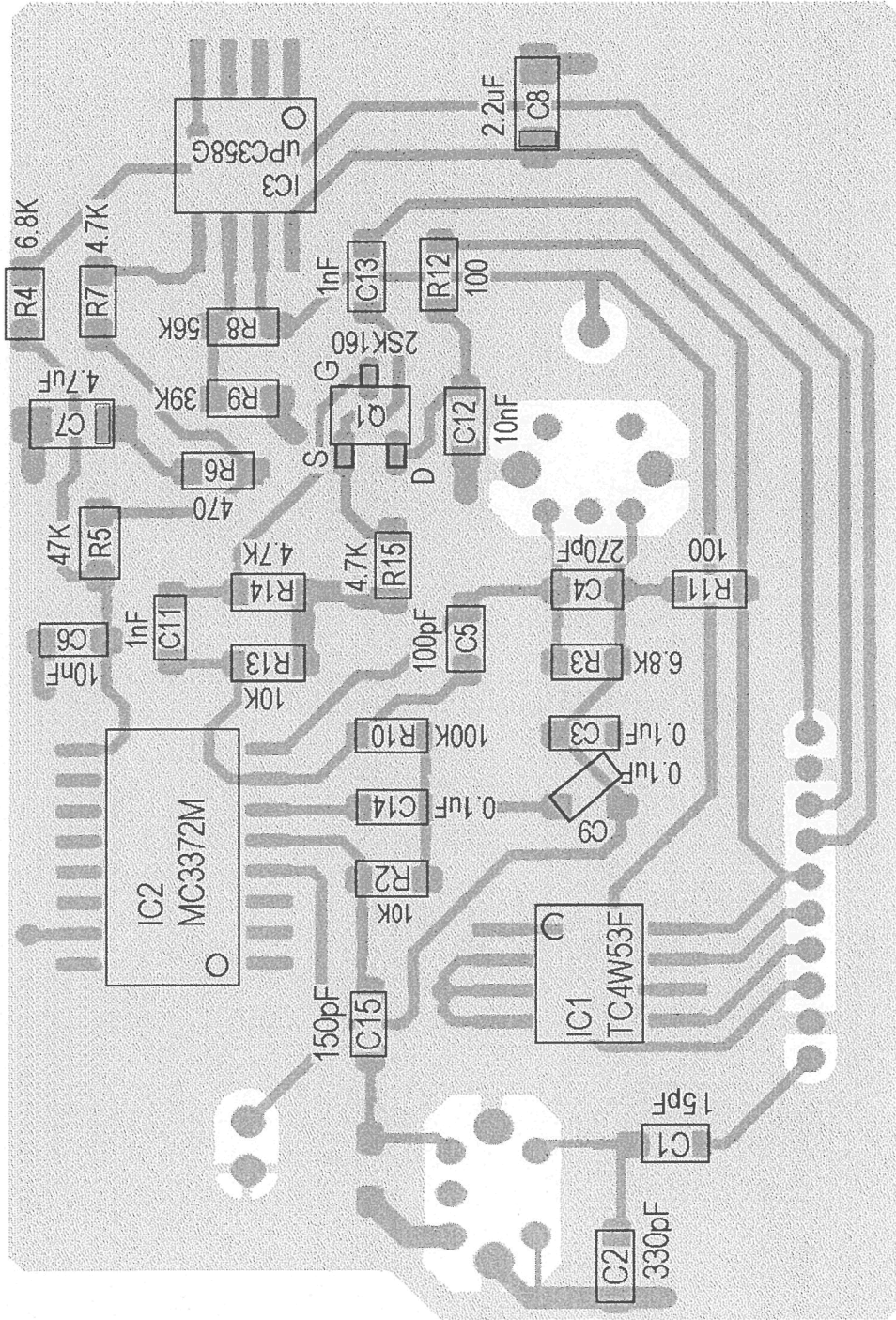

AR5K AFC UNIT SOLDER SIDE

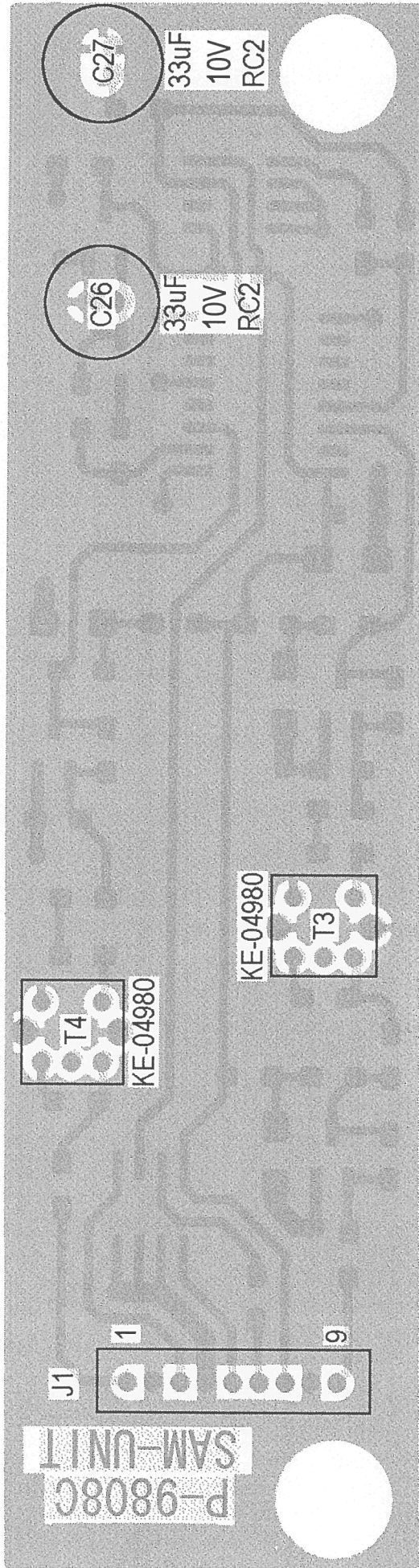

AR5K SAM UNIT COMPONENT SIDE

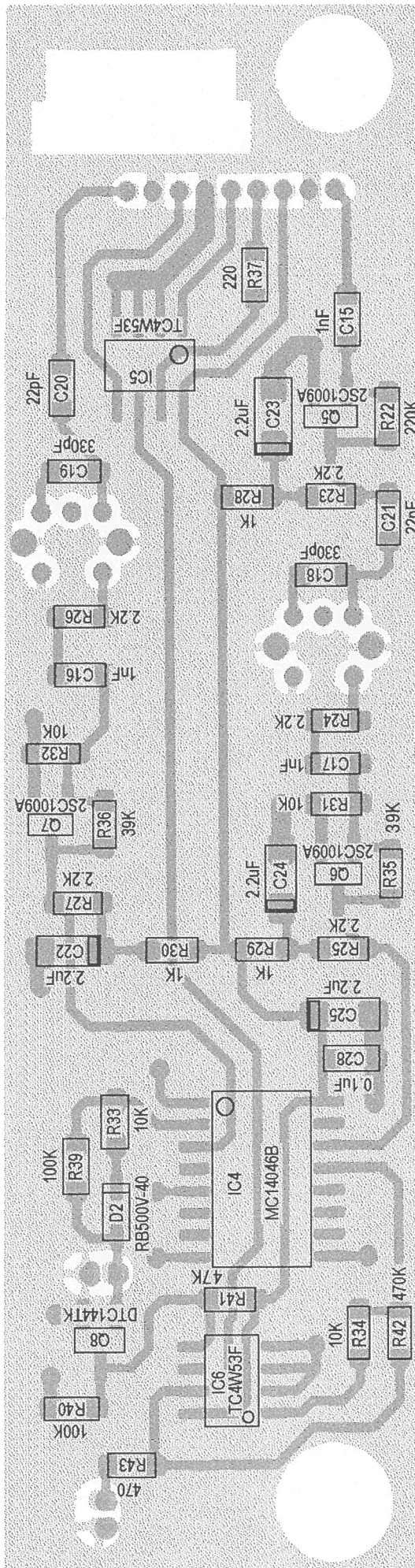

AR5K SAM UNIT SOLDER SIDE

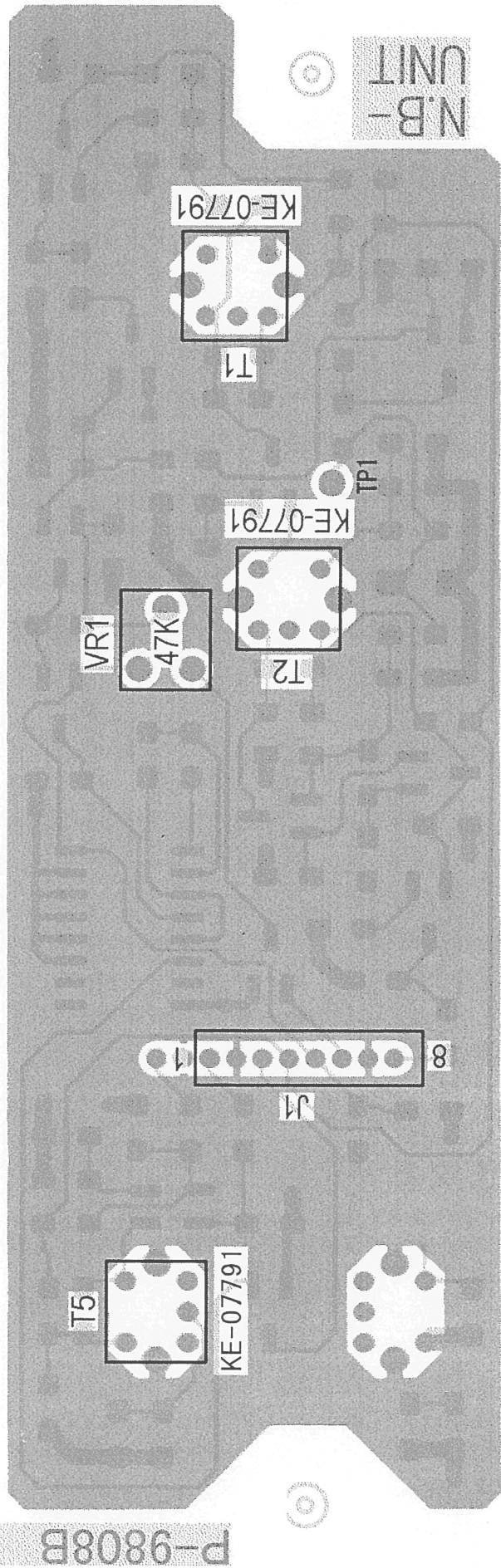

AR5K N.B UNIT COMPONENT SIDE



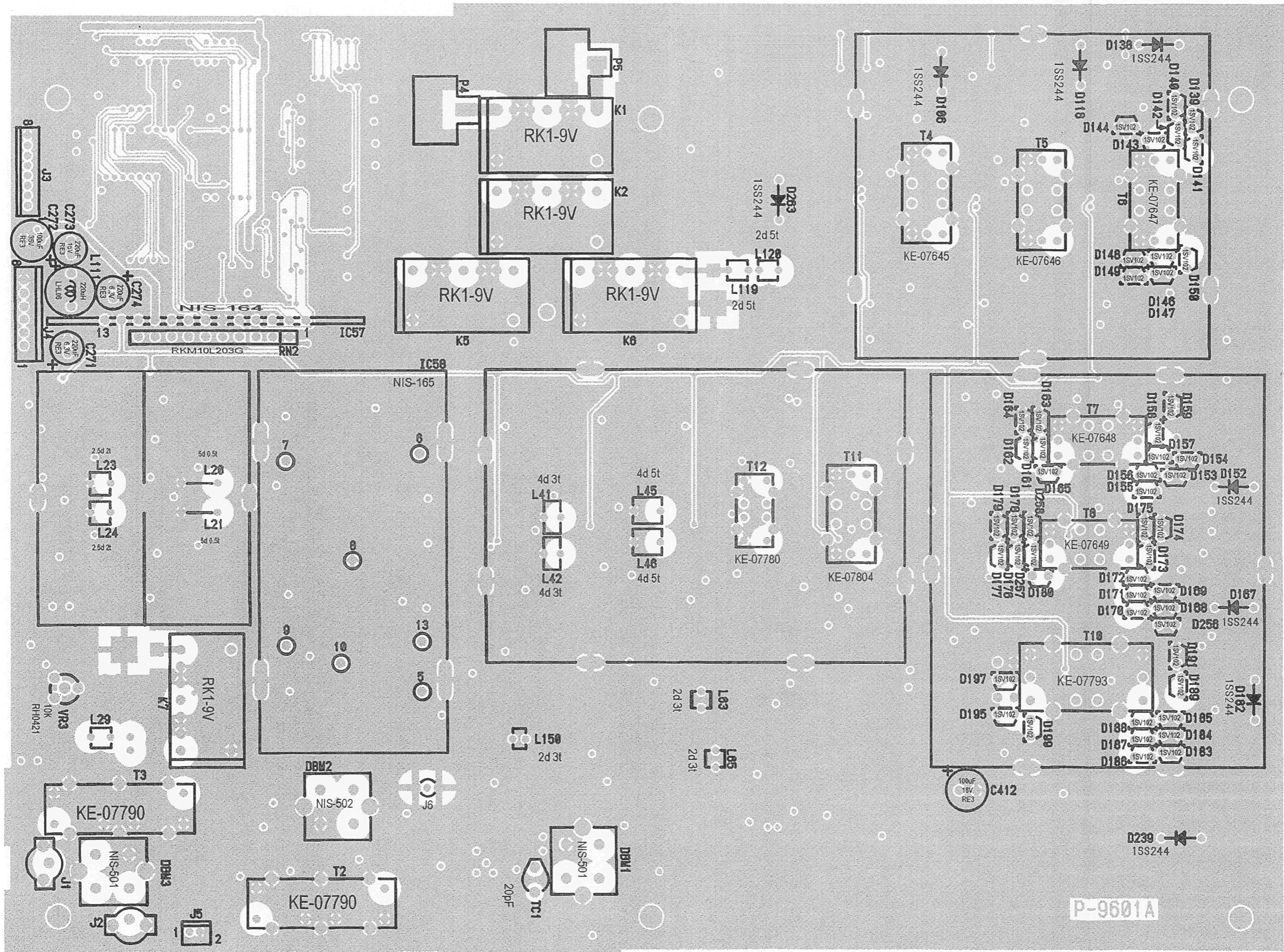

AR5K FRONT UNIT COMPONENT SIDE



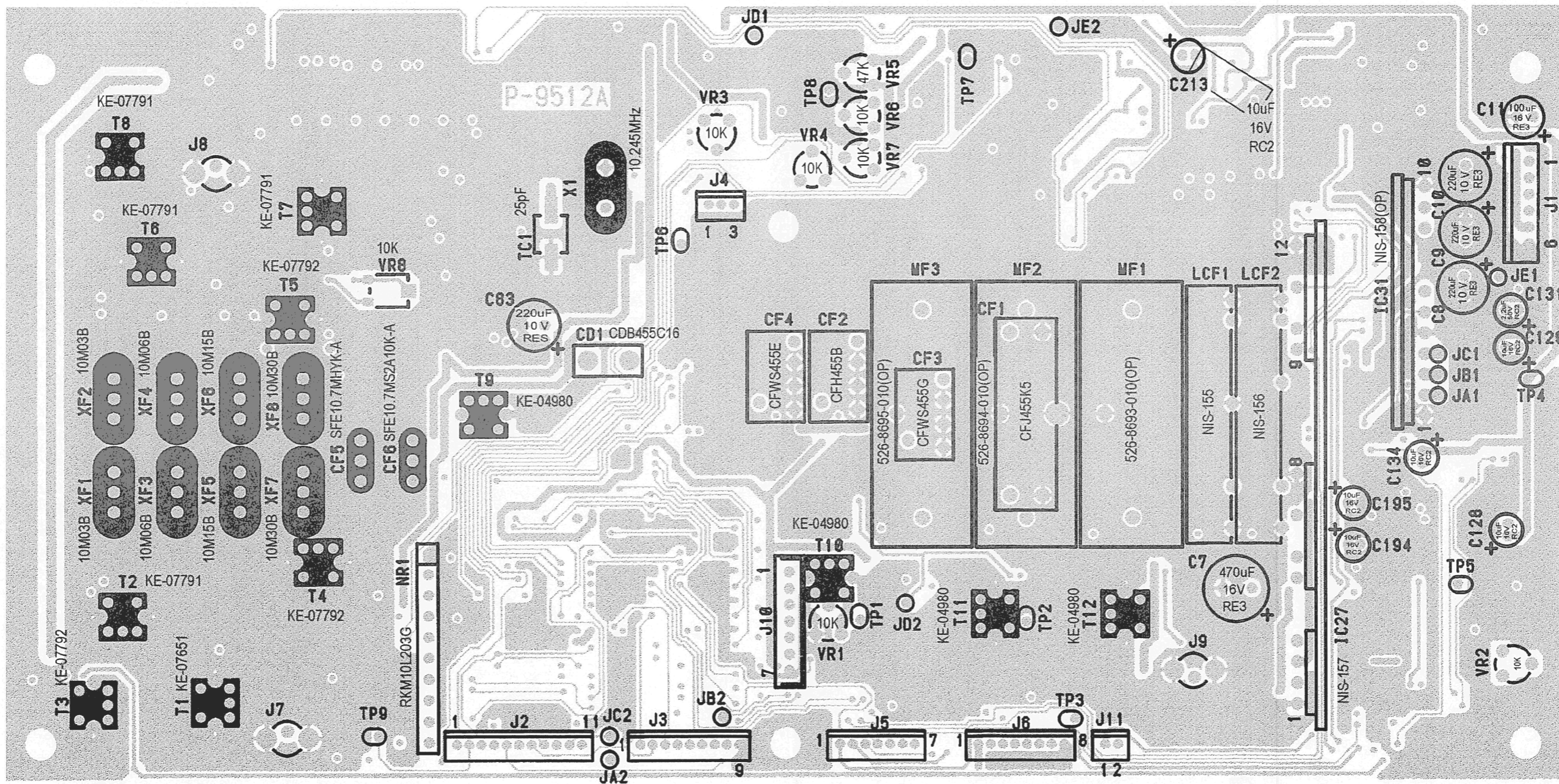

AR5K IF\_UNIT COMPONENT SIDE



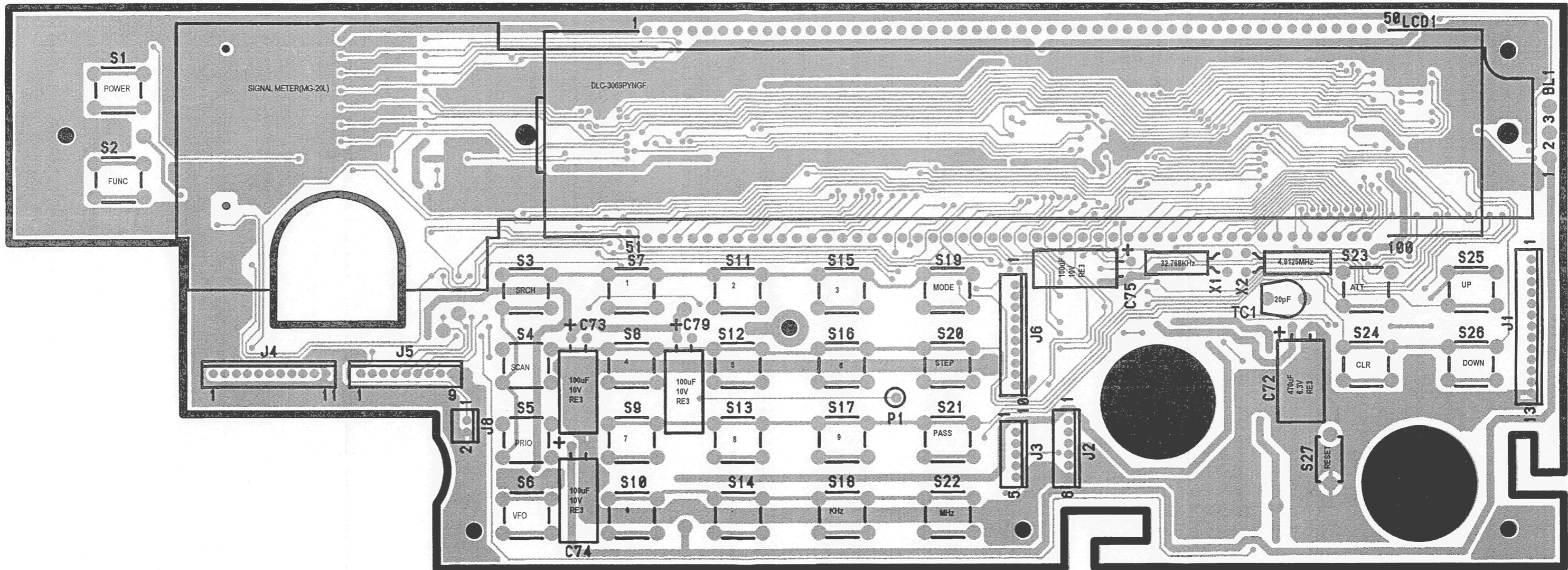

AR5K CPU\_UNIT COMPONENT SIDE

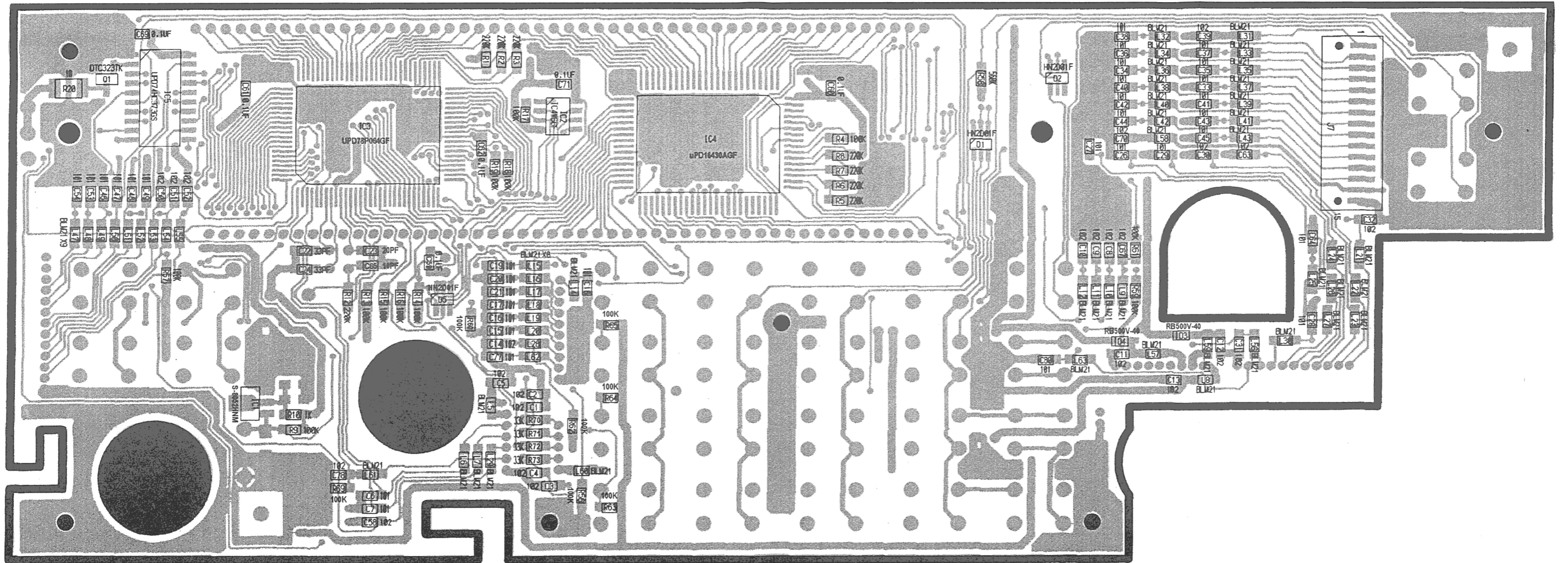

AR5K CPU UNIT SOLDER SIDE

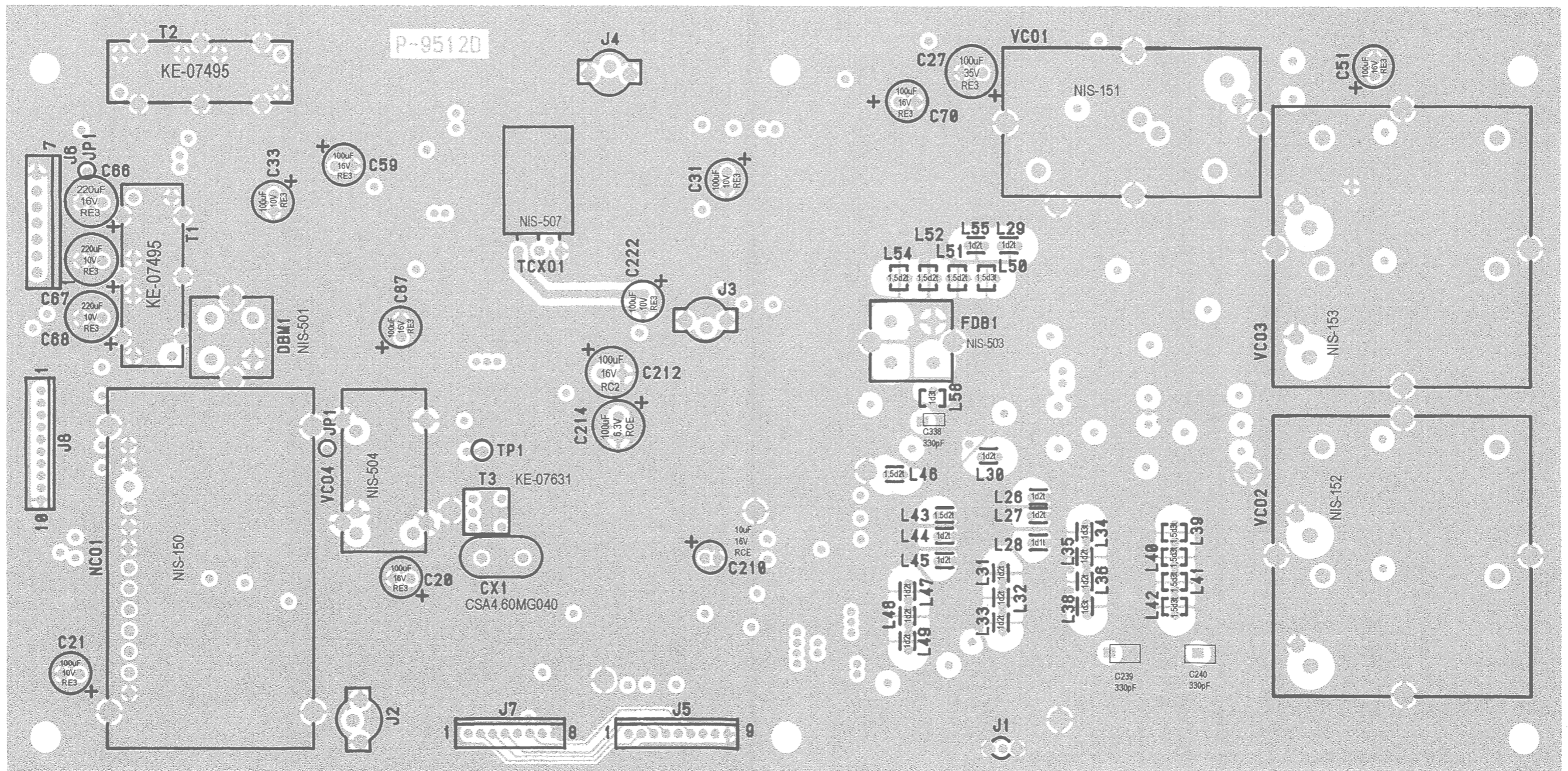

AR5K PLL\_UNIT COMPONENT SIDE

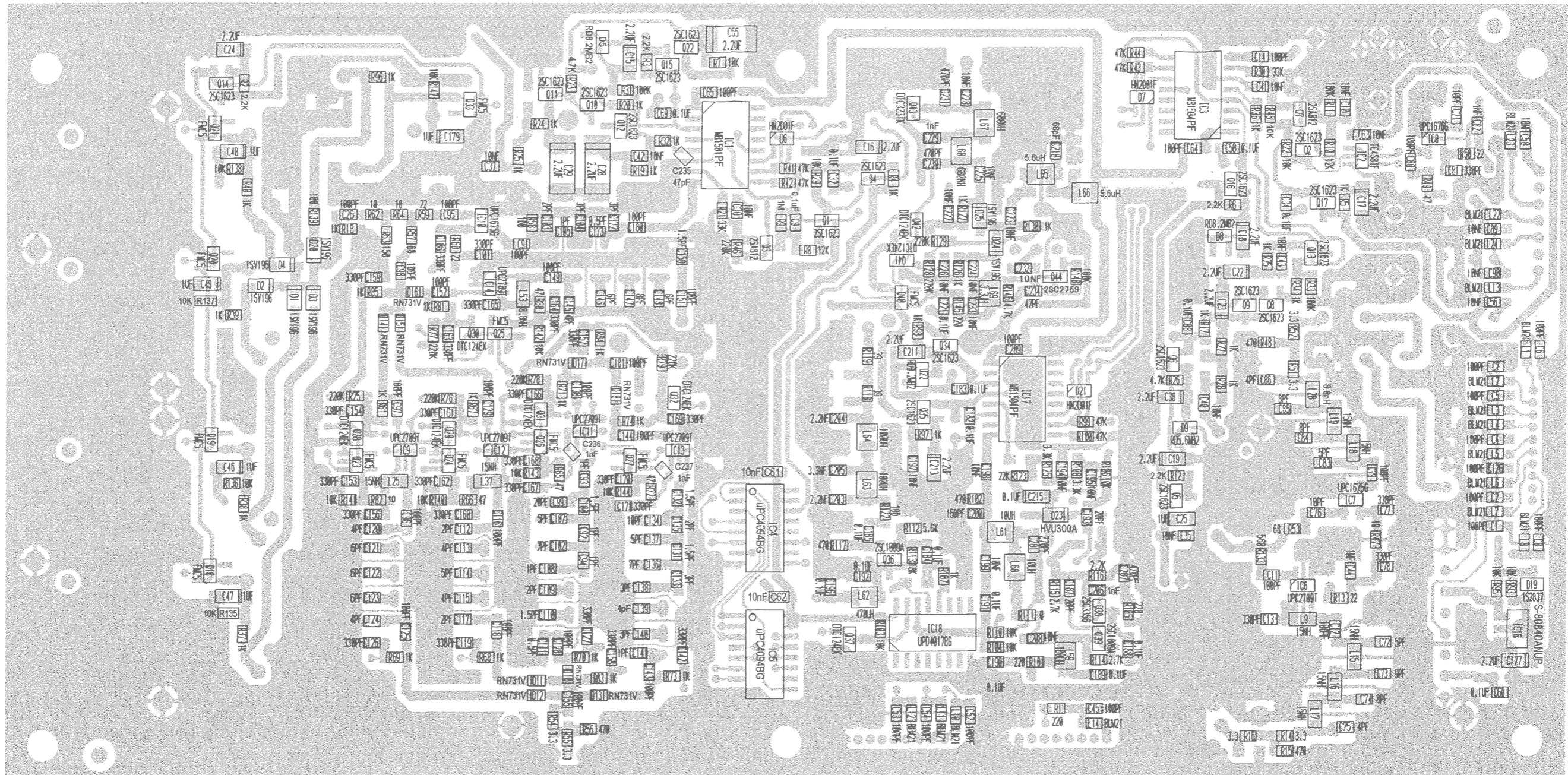

AR5K PLL\_UNIT SOLDER SIDE