

LITEMALADSP

# Product manual

—MLite-880

version: V2.2

Release date: March 27, 2026

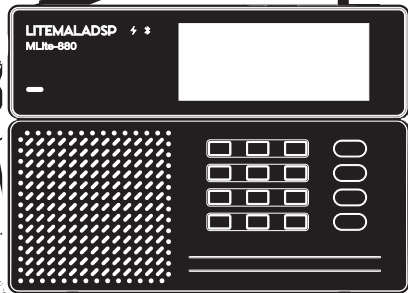

## Thank you for choosing the MLite-880

Official Sales Link for MLite-880: <https://www.elecevolve.com/products/mlite-880>

More resources and technical support are available on the official self-built mall. Follow us to get a better device experience.

- ✓ Official Firmware Updates: Get performance optimizations and new features as soon as they are released.
- ✓ Complete Documentation: User manuals, application guides, drivers, software tools, etc.
- ✓ Efficient Self-Service: Specialized FAQ library to quickly resolve common issues.
- ✓ Professional Human Support: Professional engineers provide pre-sales and after-sales technical support online.
- ✓ Genuine Accessory Guarantee: Offer original equipment accessory services for your device.
- ✓ Knowledge Sharing Community: Product usage knowledge sharing, new product information, etc.

[Official Mall] Please visit: <https://www.elecevolve.com/>

[Official YouTube Channel] Please visit: <https://www.youtube.com/@elecevolve>

[Facebook] Please visit: <https://www.facebook.com/groups/903775729255536>

[Official Blog] Please visit: <https://www.elecevolve.com/blog/>

# Functions and Operating Components Introduction

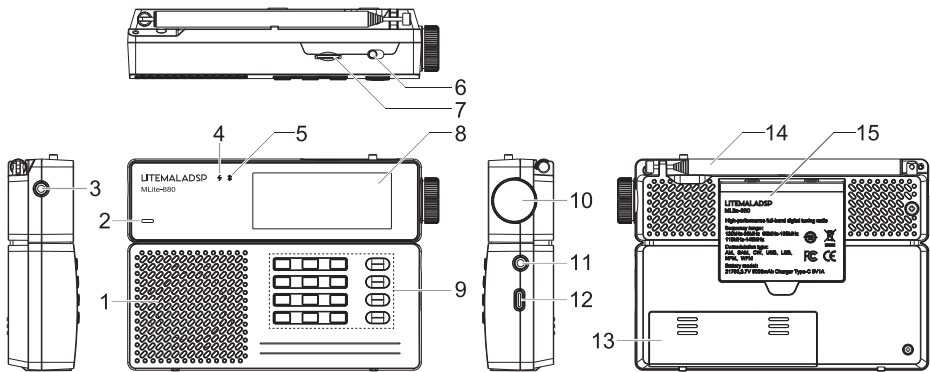

1	Speaker	5W	9	Key board	
2	Power LED	Blue	10	TUNING	Encoder with switch
3	Ext Antenna	AUX to SMA	11	EARPHONES	Stereo Out
4	Charging LED	Green/Red	12	TypeC	External power supply charging input
5	Bluetooth LED	Blue		Data interface	
6	ON-OFF	Power Switch	13	BATTERY COMPARTMENT	
7	TF	MICRO SD (16G)	14	Antenna	Rod Antenna
8	LCD	DOTS192X64	15	Support frame	

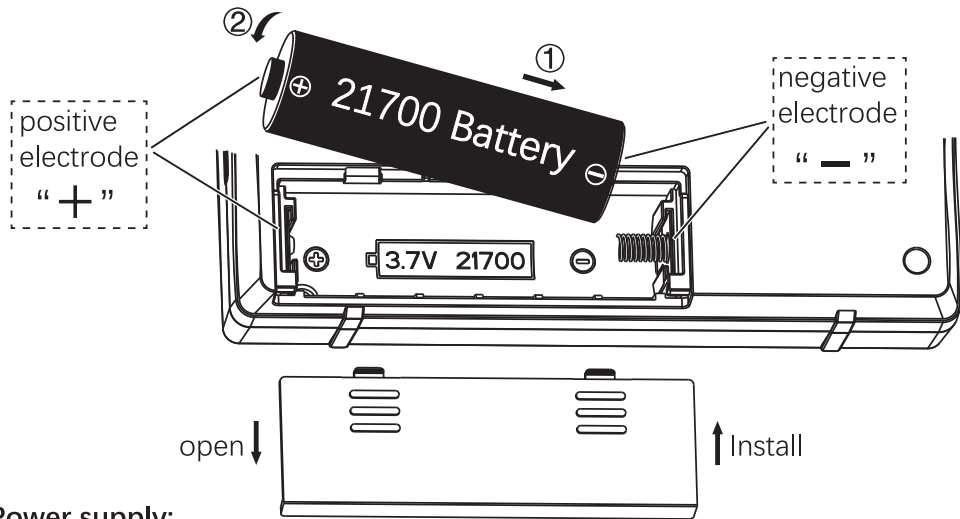

### Power supply:

MLite-880 is powered by a 21700 3.7V rechargeable lithium battery.

Place a 21700 lithium battery in the correct polarity direction in the battery compartment.

You can also use a power adapter (5V1A) connect to the Type C







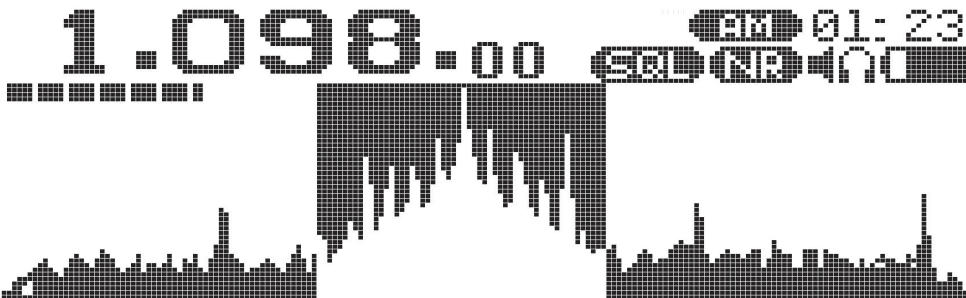









Charging-LED flashes red during charging, Charging-LED flashes green after charging is completed

Attention: This device is not suitable for fast charging

# MĀLAHITEAM



# Display function indicator

Indicator	Description	Operate	Indicator	Description	Operate
	S meter	[5]-[A]-[1]		AM mode	[2]-[5]
	Audio output	[A]		SAN mode	[2]-[6]
	SQL trun on	[B]		NFM mode	[2]-[7]
	NR trun on	[C]		WFM mode	[2]-[8]
	USB mode	[2]-[1]		Volume:	[Knob]
	LSB mode	[2]-[2]		RDS	[5]-[5]
	CW mode	[2]-[3]		Time	
	DSB mode	[2]-[4]		Battery	

# Operating instructions

The operation of MLite-880 is based on the combination of keyboard and knob

**TUNING**

Encoder with  
switch

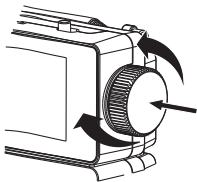

Key board

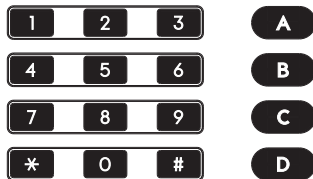

## KeyBoard Introduction

Key	Description	Key	Description
[Knob KEY]	Volume / Frequency	[5]	Display Settings /option 5
[A]	Audio output channel selection	[6]	Audio Settings
[B]	SQL enablement	[7]	Recording Menu
[C]	NR enablement	[8]	Channel Record
[D]	Return	[9]	Screen OFF
[1]	Frequency Step Menu/Option 1	[0]	Bands
[2]	Modulation mode menu/Option 2	[*]	Multi functional keys
[3]	Device Menu /Option 3	[#]	Enter
[4]	Manually enter frequency/option 4		

## Keyboard button [1] - Frequency Step Selection menu



Frequency Step: Used to adjust the encoder step size

Press key [1] - [9] to select the applicable option, Press key [D] to Exit menu

---

## Keyboard button [2] - Modulation Mode Selection menu

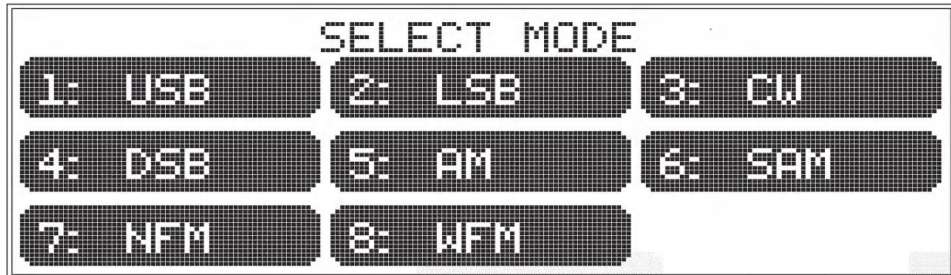

**Mode menu:** Used to set the receiving mode

Press key [1] - [9] to Select the desired demodulation mode      Press key [D] to Exit menu

\* WFM is only available within the frequency range of 65-108MHz

---

### Keyboard button [3] - Device Menu

Press key [A] / [B] to change interfaces (2 pages)

Press key [1] - [5] to select configuration item

Press key [D] to Exit menu

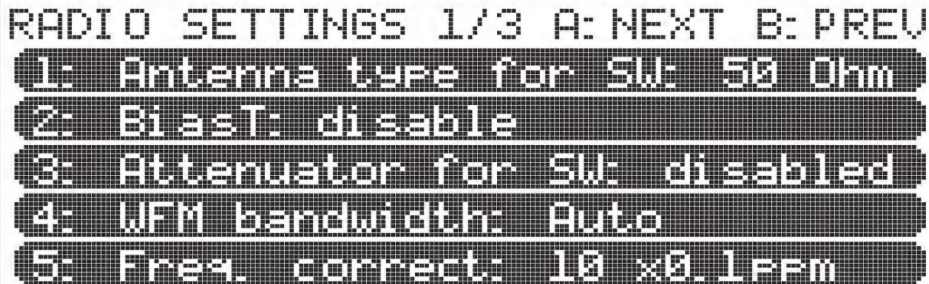

```
RADIO SETTINGS 1/3 A: NEXT B: PREV
1: Antenna type for SW: 50 Ohm
2: BiasT: disable
3: Attenuator for SW: disabled
4: WFM bandwidth: Auto
5: Freq. correct: 10 x0.1PFM
```

- [1] Select input antenna impedance for SW: 50 Ohm / Hiz

- [2] Turn on/off the power LED: disable / enable

- [3] High frequency attenuator (ATT) : disabled / 6 -36

\* Rotate [knob] to adjust the ATT value(db)

- [4] WFM bandwidth adjustment : Only valid in FM mode
  - \* Rotate [knob] to adjust the bandwidth value(56kHz-311kHz)
- [5] Frequency offset correction
  - \* Rotate [knob] to adjust the frequency offset (+-0.1ppm)

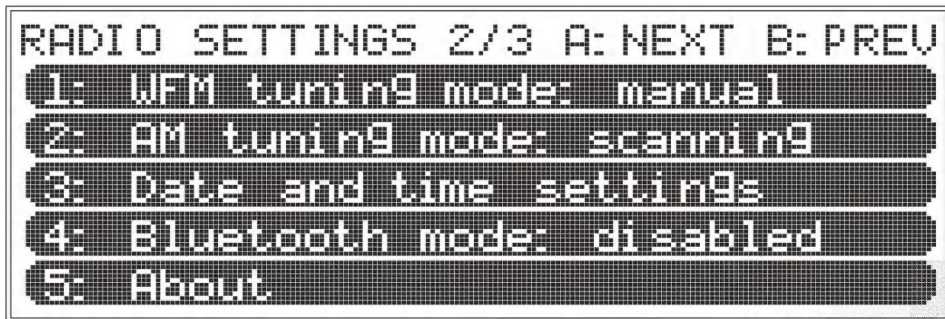

- [1] WFM channel search mode: manual / scanning
- [2] AM channel search mode: manual / scanning
  - \* IN scanning mode, return to the main interface.
  - Rotate [knob] forward or backward to search for channels up or down
- [3] Date and time settings
  - \* 1. Time setting <HH: MM> Enter the time by pressing the keyboard digits
  - \* 2. Date setting <DD: MM: YYYY> Press key [A] to save, Press key [D] to return.

- [4] Bluetooth function: disable / enable
  - \* Enable the bluetooth, MLite-880 will searching bluetooth peripherals automatically.
  - Enable broadcast mode of your Bluetooth peripheral.
  - MLite-880 will automatically connect to the target device after it is be found.
  - Bluetooth LED will turn on when successful connection.
  - \* Restart Bluetooth When replacing other Bluetooth peripherals.
- [5] Device info: Software version and device ID

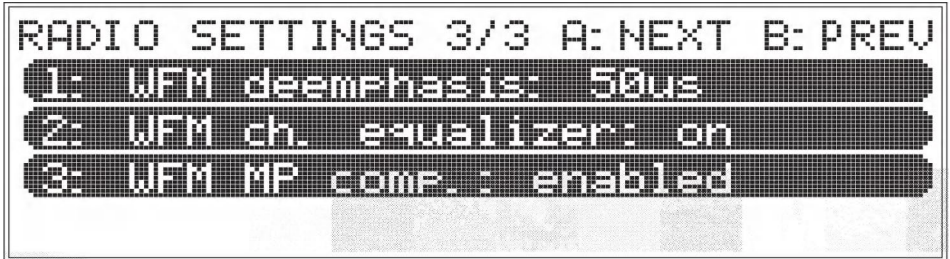

- [1] WFM deemphasis: disabled / 50us / 75us
  - \* Rotate [knob] FM de-emphasis time constant
- [2] WFM ch. equalizer: disabled / on
  - \* FM channel equalizer
- [3] WFM MP comp: enabled / disabled
  - \* FM multipath suppression mode

## Keyboard button [4] - Manually Input Frequency

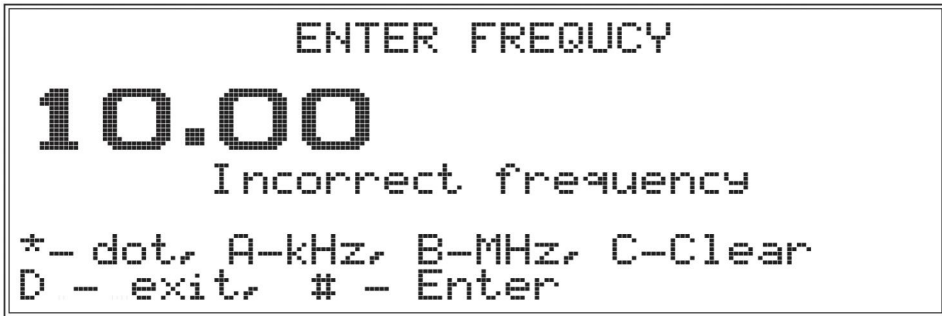

Input Frequency by pressing the keyboard buttons

- [1] - [9] input numbers
- [A] end of "kHz" units
- [#] Confirm input
- [D] Exit menu
- [\*] input small points
- [B] end of "MHz" units
- [C] Cancel input

\* EXA: Target frequency 10.00MHz, you may input [1], [0], [\*], [0], [0], [B].

---

## Keyboard button [5] - Display Settings

Press key [A] / [B] to change interfaces (2 pages)

Press key [1] - [5] to select configuration item

Press key [D] to Exit menu

VISUAL SET. 1/2 A: NEXT B: PREV

1: Brightness level: maximal

2: Brightness off time: 30

3: Spectrum average: 80

4: Spectrum fill: enable

5: RDS view: disable

- [1] LCD brightness level: maximal / middle / minimal
  - \* Rotate [knob] to adjust the brightness level
- [2] LCD brightness off time: disable / 5 S - 300S
  - \* Rotate [knob] to set the brightness off time
- [3] Average value of frequency spectrum curve : 50 - 99
  - \* Rotate [knob] to set the value
  - \* The higher the value, the smoother the appearance of the frequency spectrum curve
- [4] frequency spectrum curve fill: disable / enable equenc
  - \* Display spectra in line or color form
- [5] RDS view: disable / enable
  - \* Display RDS information on the screen in FM mode: PI: XXXX

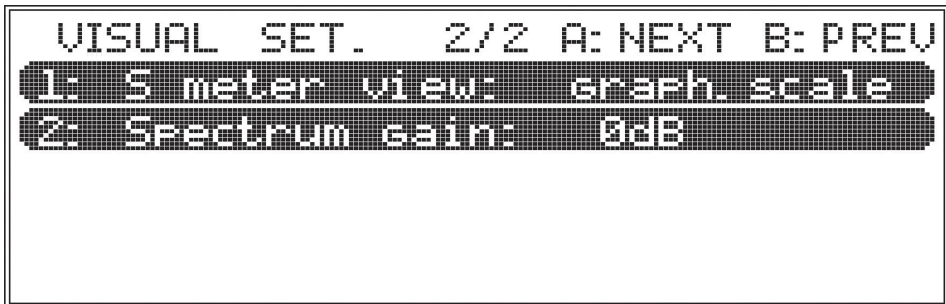

- [1] S meter view: disable / value in dBm / graph. scale
  - \* graphically or numerically indicating signal strength
  - \* Invalid in FM mode
- [2] Frequency pectrum gain: -20 to 20dB
  - \* Adjust the Y-axis scale value of the spectrum curve
  - \* Rotate [knob] to set the value

---

## Keyboard button [6] - Audio Settings

Press key [A] / [B] to change interfaces (3 pages)

Press key [1] - [5] to select configuration item

Press key [D] to Exit menu

AUDIO SETTINGS 1/3 A: NEXT B: PREV

1: Flt type: Narrow

2: Flt low freq: 0.00kHz

3: Flt high freq: 12.00kHz

4: NR level: 17

5: WFM stereo: disable

- [1] Filter type: Narrow / Normal / Wide
  - \* Rotate [knob] to set the wave filter type
  - \* Default threshold for narrowband: 0.00Hz - 8.00Hz
  - \* Default threshold for normalband: 0.00Hz - 12.00Hz
  - \* Default threshold for wideband: 0.00Hz - 15.00Hz
  - \* The threshold can be manually adjusted and save it in the corresponding type
- [2] Low threshold setting:
  - \* Rotate [knob] to set the frequency(Auto save)
- [3] High threshold setting:
  - \* Rotate [knob] to set the frequency(Auto save)
- [4] NR level 0 - 30

- \* Rotate [knob] to set the NR threshold
  - \* Only effective when NR enabled (Black to main interface, press key [C])
  - \* Invalid in FM mode
- [5] WFM stereo: disable / enable
- \* Use external headphones/speakers through audio port or Bluetooth

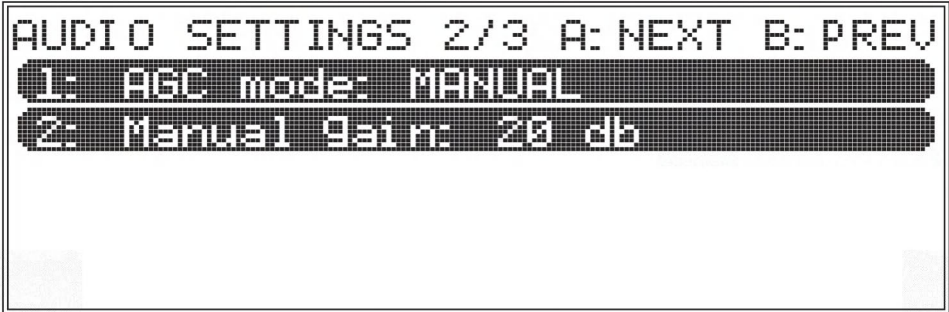

- [1] AGC mode: MANUAL/FAST/MIDDLE/SLOW/LONG
  - [2] AGC limit: 40 - 90(db)
  - [3] AGC gain: 0 - 60(db)
- \*Rotate[knob] to set the AGC mode and AGC threshold(db)

```
AUDIO SETTINGS 3/3 A: NEXT B: PREV
1: NB mode: NB disable
2: NB threshold: 2.1
3: Equalizer type: SOFT
4: Key beep level: 1
5: SQL threshold: -117
```

- [1] NB mode: NB disable / 1 / 2
  - \* pulse suppression mode, Noise blanker
  - \* Rotate [knob] to set the NB mode
- [2] NB threshold : 2.1 - 20.0
  - \* threshold of activation of the pulse suppressor
  - \* Rotate [knob] to set the NB threshold
- [3] Equalizer type: VOICE / POP / JAZZ / BASS / ROCK / CLUB / LIVE / SOFT / EQ OFF
  - \* the selected type of equalizer.
  - \* Rotate [knob] to select
- [4] Key beep level: key beep off / 1 - 20
  - \* the level of "beep" when pressing key

- \* Rotate [knob] to adjust the value
- [5] SQL threshold: -30 dBm - -120 dBm
  - \* the threshold for triggering the SQL noise suppressor
  - \* Rotate [knob] to set SQL

---

## Keyboard button [7] - Recording Menu



Firstly, set the channel to be recorded on the main interface and press the keyboard button [7] to enter the recording menu.

- [1] START
  - \* Rotate [knob] to adjust the audio gain level when recoding
  - \* The recording indicator should be approximately at the level of half to  $\frac{3}{4}$  of the scale
- [2] STOP

- \* Simultaneously return the record list
  - \* Create a file of the current recording content and automatically add it to the list
  - \* Information: channel, file size, date
- [3] PLAY
- \* Rotate [knob] to Select a file , press key [3] to play, [2] Return to List
  - \* press key [knob key] to convert adjust positon / adjust volume
  - \* Rotate [knob] to adjust positon / volume
- [4] PAUSE press key [2] Return to List
- [5] DELETE Need to press key [5] again to confirm deletion
- [D] Exit menu
- 

### Keyboard button [8] - Channel Record

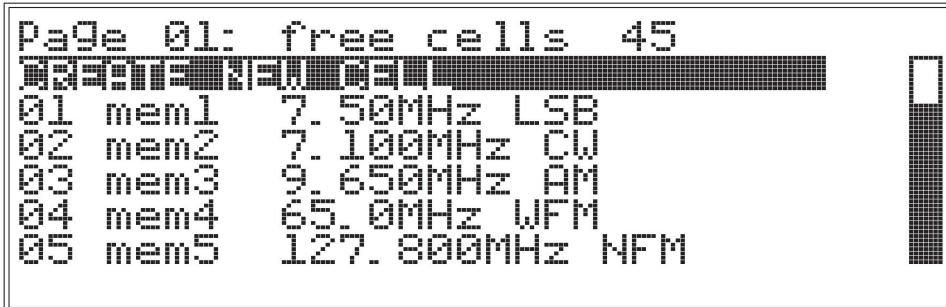

press key [A] / [B] to Switch page, Rotate [knob] to Browsing List

press key [D] to Exit menu

\* Hover the cursor at position" CREATE NEW CELL "and press [\*] to save the current channel and create it in the list. There are 10 pages, 50/page, a total of 500 channels can be saved

\* Rotate [knob] to select the saved channel, press [\*] to enter the editing page.

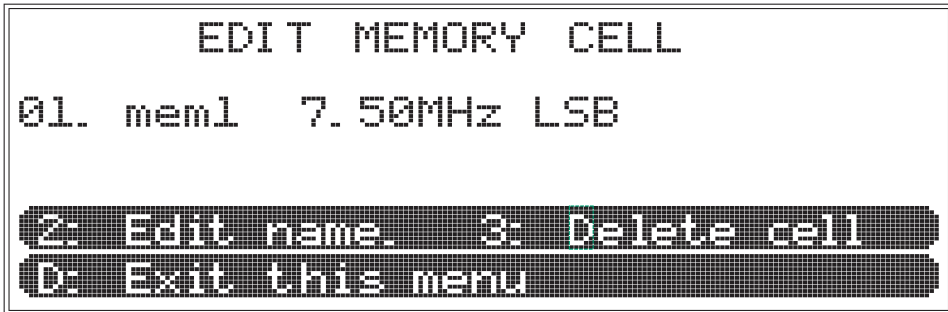

- [2] Edit name : rename
- [3] Delete cell : delete the channel from the list
- [D] Exit this menu : return

# EDIT MEMORY CELL

mem1

A: Next, B: Prev

\*: Restore text

D: Return to Previous menu

- [A] Next -[B] Prev

- [\*] Restore text --Cancel input

- [D] Return to previous menu --Save changes and return

\* Move the cursor using the [A] [B] buttons and Rotate [knob] to select text / numbers / symbols.(limit 8 characters)

---

## Keyboard button [0] - Bands

press key [A] / [B] Switch options page (1, Broadcast / 2, Amateur / 3, FM & VHF bands)

\* Rotate [knob] to Select frequency band

press key [#] to enter and return to the main interface

press key [D] to Exit menu

## Broadcast LW, MW, SW bands GEN: \*

522 kHz	-	1620 kHz	( MW )
2300 kHz	-	2495 kHz	( 120m )
3200 kHz	-	3400 kHz	( 90m )
3900 kHz	-	4000 kHz	( 75m )
4750 kHz	-	5060 kHz	( 60m )
5900 kHz	-	6200 kHz	( 49m )
7200 kHz	-	7450 kHz	( 410m )
9400 kHz	-	9900 kHz	( 310m )
11600 kHz	-	12100 kHz	( 210m )
13570 kHz	-	13870 kHz	( 220m )
15100 kHz	-	15800 kHz	( 190m )
17480 kHz	-	17900 kHz	( 160m )
18900 kHz	-	19020 kHz	( 150m )
21450 kHz	-	21850 kHz	( 130m )
25600 kHz	-	26100 kHz	( 11m )

Amateur bands		GEN: *
<del>14500kHz - 14800kHz (20m)</del>		
<del>4750kHz - 4790kHz (630m)</del>		
472kHz - 479kHz		{ 630m }
1800kHz - 2000kHz		{ 160m }
3500kHz - 3800kHz		{ 80m }
5351.5kHz - 5366.5kHz		{ 60m }
7000kHz - 7200kHz		{ 40m }
-----		
10100kHz - 10150kHz		{ 30m }
14000kHz - 14350kHz		{ 20m }
18068kHz - 18168kHz		{ 17m }
21000kHz - 21450kHz		{ 15m }
24890kHz - 24990kHz		{ 12m }
26965kHz - 27860kHz		{ CB }
28000kHz - 29700kHz		{ 10m }
70MHz - 70.5MHz		{ 4m }
144MHz - 148MHz		{ 2m }

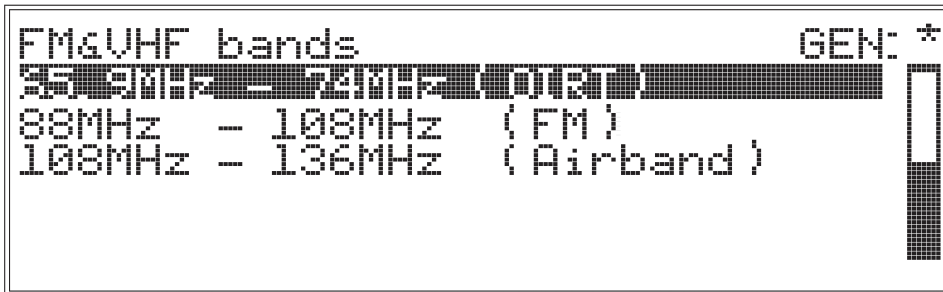

## Firmware update:

You need to turn off the device first.

Press and hold button [1] while turning on the device, then release button [1].

The screen illuminates and prompts that the device is in DFU mode.

Connect the device to the computer by Type-C cable and update firmware.

Our website offers a convenient upgrade method. Download the latest firmware from the website.

<https://www.elecevolve.com>