

Barrett 950 HF SSB Transceiver Operating and Installation Manual

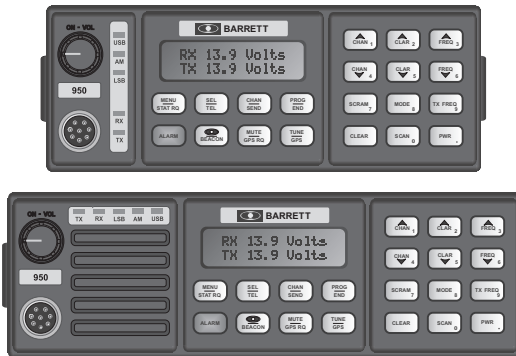

© Barrett Communications
BCM95000/4

Head office:

Barrett Communications Pty Ltd
10 Port Kembla Drive, Bibra Lake WA 6163
P O Box 1214, Bibra Lake WA 6965
AUSTRALIA
Toll Free Tel: 1800 999 580
Tel: (61-8) 9 434 1700
Fax: (61-8) 9 418 6757

European office:

Barrett Europe Limited
19 Lenten Street
Alton, Hampshire
GU34 1HG
UNITED KINGDOM
Tel: (44) 1420 542254
Fax: (44) 1420 543373

www.barrettcommunications.com.au

Introduction	6
Operation	7
Front panel description	7
Power/volume control	7
Mic. Socket	7
Status LED's	7
Display	8
Key pad	9
Channel change	10
Channel up/down	10
Direct channel entry	10
Selective Calls - alerting other stations	12
Selcall	12
Sending a selcall	12
Receiving a selcall	14
All call	14
Group call	15
Sub group call	15
Beacon call	16
Sending a beacon call	16
Receiving a beacon call	17
Sending an emergency selcall	18
Transceivers receiving an emergency call	18
Telcall's - direct dial telephone calls	19
Beacon call	19
Sending a Telcall	19
Preset dialling	19
Direct dialling	21
Last number redial	23
Hang-up call	23
Scanning channels	25
Halting scan	25
Selcall Scan	26
Signal strength scan (SSL scan)	26
Voice (syllabic) scan	26
Enabling channels into scan tables	27
Clarifier	28
Mute types	29
Audio (syllabic) mute	29
Selcall mute	29
Signal strength mute	29
Mode selection	30
LSB mode	30
USB mode	30
AM mode	30
CW mode	30
AFSK mode	30
Alarm operation	31
International marine radiotelephone two-tone alarm	31
RFDS alarm	31
Testing the alarm	31
Sending an Alarm	31
Transmit frequency monitoring	32

Tune.....	32
Scrambler	33
RF output power	34
Advanced selective call functions	35
Requesting another transceivers GPS position.....	35
Sending your GPS position to another transceiver	37
Pagecall.....	39
Status selcall (Statcall).....	40
Selective call history	43
Accessing selcall history	43
Making a call from the history buffer	43
Types of selcall history	43
Tuning receiver	45
Tuning.....	45
Scanning the tunable receiver	46

Menu functions 48

Menus	48
Open menu	48
Identification.....	48
Noise blanker.....	49
Display back-light levels.....	49
Display back-light options	50
Display options	51
Battery level	52
Protected menu	53
RF pre-amplifier.....	53
Set Scan Rate.....	54
Set Scan Dwell	54
Set Signal Strength threshold Level (SSL).....	54
External control options	55
Transmit “over beep”.....	56
Transmit timeout	56
Clarifier Limit.....	57
Set Selcall I.D's.....	57
Set Selcall Pre-amble	58
External alarm type	58
Scrambler - hardware option enable	59
Silent mode.....	59
GPS type	60
500Hz Filter - hardware option enable	60
Scan resume time.....	61
Microphone Up/Down buttons.....	61
Cloning and programming transceivers	62
Cloning	62
Remote / Local configuration	66
BITE menu.....	67
Transceiver lock.....	69
To lock out (disable) a transceiver.....	69
To un-lock a transceiver	70

Programming functions 71

Programming steps.....	71
------------------------	----

Automatic Link Establishment - ALE - option.....76

- ALE system overview.....76
- Operation overview.....76
- Commence ALE scanning.....77
- Receiving an ALE call directed to your transceiver.....78
- Calling another ALE station.....79
- Making an telephone call via an ALE equipped Barrett 960 telephone interconnect.....82
- Closing an ALE link.....85
- ALE menus.....86
 - ALE default.....87
 - Sounding.....87
 - Link quality decay time.....88
 - Sounding Signal Length.....89
 - Bit Error Rate (BER) threshold.....90
 - Golay threshold.....90
 - Bad word count.....91
 - Call Retry Limit.....91
 - LQA averaging.....92
 - ALE silent mode.....93
 - ALE fill mode.....94
 - ALE disable.....94

Installation.....95

- General.....95
 - Introduction.....95
 - Unpacking and inspection.....95
- Fixed station installations.....96
 - Transceiver position.....96
 - Operating convenience.....96
 - Air circulation.....96
 - Proximity of transceiver to antenna.....96
 - Power supply.....96
 - Voltage drop.....97
 - Protection fuse.....97
 - Antenna.....97
 - 912 Single Wire Broadband Dipoles.....98
 - 912 Multiwire Broadband Dipoles.....100
 - 913 series helical dipoles.....102
 - 915 wire dipole.....104
 - Barrett 911 Automatic Antenna Tuner for base station installations.....106
- Mobile installations.....108
 - Transceiver position.....108
 - Safety.....108
 - Convenience.....108
 - Strength.....108
 - Air circulation.....108
 - Obstruction.....109
 - Power wiring.....109
 - Antenna.....110
 - Antenna mounting.....110
 - Antenna feed cables.....110
 - Voltage standing wave ratio (VSWR).....110
 - Noise suppression.....111
 - Interference suppression kit.....111

Ignition systems	112
Coil to battery wiring	112
Battery charging system	112
Alternator / generator to battery wiring	112
Alternator to regulator control wire	112
Other regulator wires	112
Other noise sources	113
General noise suppression tips	113
914 series manual tap whip antenna	114
910 automatic tuning mobile antenna	117
Marine Installations	121
General	121
Antenna selection	121
Antenna	121
Transceiver and tuner mounting.....	121
Ground (earth) system	121
Corrosion	122
Portable Operation.....	124

Auxiliary connector	126
----------------------------------	------------

Overview of HF operation	128
---------------------------------------	------------

Accessories	132
--------------------------	------------

Accessory interface	132
Cable assembly.....	133
Universal mounting cradle	133
Fan unit	134
Side-plate kits.....	135
19" rack mount conversion kit	136
Interference suppression kit	137

Introduction

The Barrett 950 transceiver is a sophisticated yet easy to operate, 450 channel HF SSB transceiver with a frequency range of 1.6 to 30 MHz. Designed to operate in the most arduous environments, as encountered in off road vehicles, vessels and aircraft, the Barrett 950 will provide many years of efficient and trouble free service.

The Barrett 950 supports features such as selective call (Selcall), direct dial telephone connection to base stations fitted with telephone interconnect systems (Telcall), GPS location, ALE (Automatic Link Establishment), data transmission and remote diagnostics. These features make the Barrett 950 HF transceiver one of the most economical and versatile HF transceiver available today.

The Barrett 950 transceiver, has catered for the increased use of HF data transmission for Internet email access and point to point data applications, by providing a comprehensive data modem interface port, high speed transmit to receive switching, a high stability frequency standard option and an efficient inbuilt cooling system option.

The Barrett 950 transceiver is available in a local (desktop) configuration for base station applications or in a remote control (trunk mount) configuration for mobile applications. A combination of both of these configurations allows the 950 to be controlled from two positions, simultaneously if required.

Operating from 12 volt (13.8 VDC) DC supplies, the transmitter is rated at 125 watt PEP in voice mode and is protected from over-voltage or reverse voltage application.

All 450 channels are available to be field or workshop programmable. Auxiliary features such as selcall, telcall, scanning, mute status, alarm system etc. can be individually enabled or disabled for every channel as required to suit your operation.

Teamed with other matching Barrett 900 series products which include antennas, power supplies, vehicle tracking packages and HF modems, the Barrett 950 HF transceiver becomes a powerful tool, providing solutions to many long distance communication requirements.

Operation

Front panel description

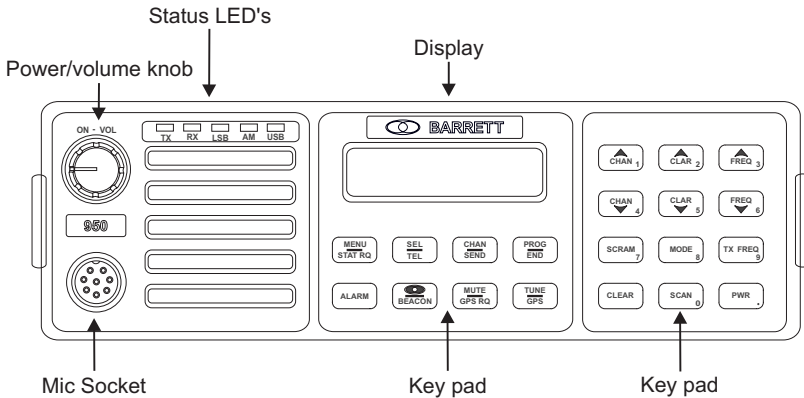

Power/volume control

The Barrett 950 transceiver is turned on by rotating this control clockwise. Turn the control clockwise until volume is set to correct level.

Mic. Socket

The microphone supplied with the Barrett 950 is inserted here.

Status LED's

This group of LED's indicates the mode currently in use. When receiving the green Rx LED is illuminated, when transmitting the red Tx LED is illuminated. The operating mode of the transceiver is indicated by the remaining LED's. (i.e. USB, LSB, AM).

Display

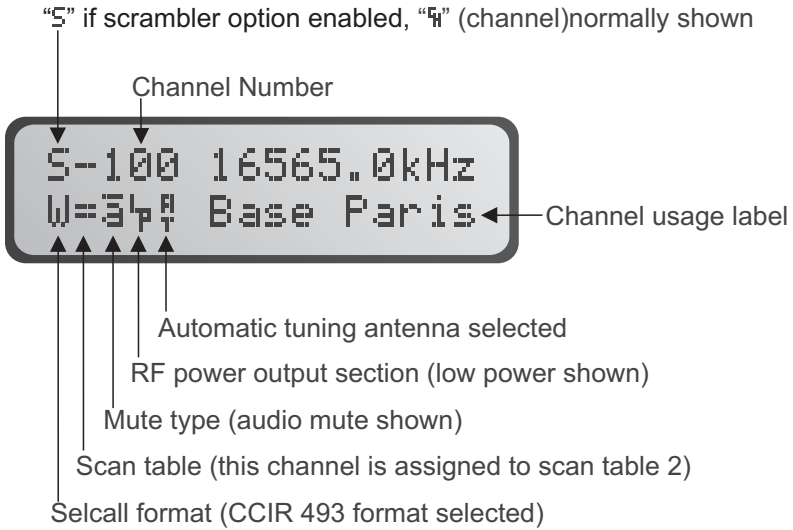















The Barrett 950 uses a supertwist 2 line by 16 character liquid crystal display (LCD).





The LCD provides the user with current status information of the transceiver including :-

- Channel number** **Channel frequency** **Mode of operation** **Channel usage**
- Local characteristics** (parameters unique to the channel in use.)
- Global characteristics** (parameters that affect all channels.)

Key pad

There are 20 keys on the keypad. Most keys have multiple functions assigned to them depending on when the key is pressed. Key functions are listed below followed by a detailed description of their functions.

Key	Key Primary function	Secondary function
	Selcall alarm reset	Menu access, send request status
	Selcall / telcall / ALE initiate	Selcall history
	Alarm Emergency selcall send	Alarm test
	Direct channel change	Send selcall / telcall / ALE
	Mute select	Send GPS position request
	Program channel	Hang-up telcall
	Tune mode	Send GPS position data
	Channel up	General scroll key Numeric key "1"
	Channel down	General scroll key Numeric key "4"
	Clarifier up	General scroll key Numeric key "2"
	Clarifier down	General scroll key Numeric key "5"
	Receiver tune up	General scroll key Numeric key "3"
	Receiver tune down	General scroll key Numeric key "6"
	Turn scrambler on / off	Numeric key "7"
	Mode select USB, LSB, AM, CW, AFSK	Numeric key "8"

Key	Key Primary function	Secondary function
	Display channel transmit frequency	Numeric key "9"
	Start scan, hold for 2 seconds select scan table	Enable / disable scan Numeric key "0"
	Delete character or abort function	-
	High or low power select	Decimal point
	Future and custom functions	Beacon call

Channel change

Channel up/down

Pressing the channel up or down key will select respectively the next higher or lower programmed channel. Holding down either of the keys will cause the rate of the channel change to increase. The channel up/down keys on the microphone have the same function as the channel up/down keys on the keypad.





Channel up



Channel down

Direct channel entry steps

- press the  key
- enter the channel number required, using the numeric keys, channel range is from 1 to 9999 inclusive. **Note:- Channel zero cannot be selected.**
- press the  key again

Using direct channel entry to select channel 101- example.

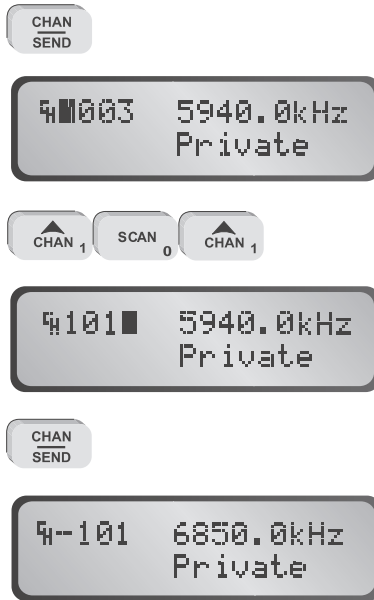

If the channel selected has not been previously programmed then the following is displayed:-



Note: Empty channels can only be accessed by direct channel selection and are not displayed when scrolling through channels.



Selective Calls - alerting other stations

Selcall

Selcall is a digital system of signalling between HF transceivers. Each transceiver is assigned an individual ID (identification) and can be called using this ID.

Note:- For selcall functions to operate the transceiver must be fitted with the selcall / telcall option and the channels enabled for selcall operation.
If ALE is in used refer to the ALE section for details on the integration of the ALE and normal selcall.

Sending a selcall

- select the channel on which to send the selcall.
- listen for traffic on that channel, if no traffic is heard then continue.
- press the  key.
- enter the desired destination ID using the numeric keys.
Note:- If you don't enter a new destination ID at this stage and proceed to the next step the default destination ID (the last received selcall callers ID or the last selcall sent ID) will be sent.
- press the  key.
- wait for the selective call to be sent.
- listen for revertive tone from the called station that indicates the call was successful.

Entering the desired destination ID

Destination ID range is from 0000 to 9999 inclusive (the destination ID **must** be 4 digits long)

All call*	will be decoded by stations X000 - X999 (up to 1000 stations)
Group call*	will be decoded by stations XX00 - XX99 (up to 100 stations)
Sub-group call*	will be decoded by stations XXX0 - XXX9 (up to 10 stations)

*Note: Only available if the destination unit has all call, group call or sub-group call enabled.

Sending a selcall to station 4321 - example

SEL
TEL

Destination ID
■234

Note:- Last selcall sent was to 1234

CHAN 4 ▲FREQ 3 ▲CLAR 2 ▲CHAN 1

Destination ID
4321■

CHAN
SEND

Sending 4321
Selcall

Note:- If no selcall has been programmed on the channel in use an error message will be generated as indicated below:-

9-100 5940.0kHz
Not a Selcall ch

Receiving a selcall

When the transceiver has a selcall enabled channel selected the transceiver monitors incoming selective calls (selcall's). (If more than one channel is to be monitored then the scan function should be used.)

Receiving a selcall directed to your transceiver

If an incoming selcall's destination ID matches the unit's selcall ID an audible alarm is sounded, mute is opened and the display shows the call as follows:

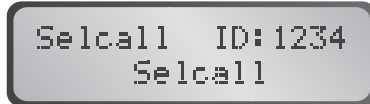

```
Selcall ID:1234
Selcall
```

The alarm will sound for thirty seconds and then time out. To stop the alarm before the time out and acknowledge the call press PTT or any key. If the alarm times out the message "Call received" will be displayed periodically on the bottom line of the display as follows:



```
4-100 16565.0kHz
Call received
```

To cancel the "Call received" message either press the clear key or send a selcall back to the calling transceiver.

All call

If the first digit of the incoming call's destination ID is the same as the unit's selcall ID and the last three digits of the destination ID are all zero (eg: 9000) then the mute is opened and the display shows the following:

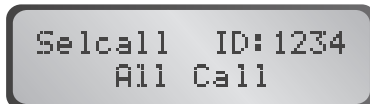

```
Selcall ID:1234
All Call
```

The mute will stay open for 20 seconds then time out. Once timed out the "Call received" message will not be displayed.

Group call

If the first two digits of the incoming call's destination ID are the same as the first two digits of the unit's selcall ID and the last two digits of the destination ID are zero then an audible alarm is sounded, the mute is opened and the displays shows the call as follows:-

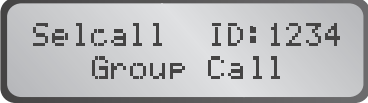

```
Selcall ID:1234
Group Call
```

The alarm will sound for three rings in 2 seconds, then leave the mute open for an additional 20 seconds then time out. To stop the alarm and/or the mute open press PTT or any key. Once timed out the "Call received" message will not be displayed.

Sub group call

If the first three digits of the incoming call's destination ID are the same as the first three digits of the unit's selcall ID and the last digit of the destination ID is zero then an audible alarm is sounded, the mute is opened and the displays shows the call as follows:-





```
Selcall ID:1234
Sub Group Call
```

The alarm will sound for 5 seconds, then leave the mute open for an additional 20 seconds then time out. To stop the alarm and/or the mute open press PTT or any key. Once timed out the "Call received" message will not be displayed.

Beacon call

The "beacon call" function allows the user to determine the signal quality between two transceivers fitted with the selcall function.

Sending a beacon call

- select the channel on which to send the beacon call.
 - listen for traffic on that channel, if no traffic is heard then continue.
 - press the  key.
 - enter the desired selcall destination ID using the numeric keys. (xx99 for a 660/960 telephone interconnect, where xx is the 660/960 I.D.)
 - press the  key.
 - wait for the beacon call to be sent.
 - listen for the beacon revertive tones.
 - repeat steps until the channel with the best signal path is found.
- Note:- The beacon revertive tones are different to a normal selcall revertive and are a series of 4 tones.

Sending a beacon call to station 4321 - example



Note:- Last selcall sent was to 1234



Receiving a beacon call

When a transceiver receives a beacon request call, it responds by transmitting the beacon call reverive tones. The beacon request call is not saved in the selcall history buffer.

Sending an emergency selcall

An emergency selcall sequence can be sent from transceivers that have emergency call channels enabled using the Barrett PC based programming system.

When the emergency call is activated the 950 transceiver sends an selcall, with a specific emergency call format, twice on each channel programmed in the emergency call sequence and continues to then repeat this sequence until the transceiver is switched off. If no emergency channels have been programmed into the transceiver then the emergency call will be made on the current channel only, but will continue to send emergency calls until the transceiver is switched off. When a revertive from a receiving transceiver is heard pressing the PTT will exit the emergency call procedure and stay on the channel the revertive was heard on.

To activate the emergency call sequence:-

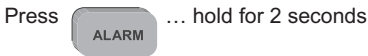

Transceivers receiving an emergency call

Barrett transceivers that receive the emergency selcall emit a distinctive audio alarm and display the following:-



If the transceiver sending the emergency selcall is fitted with a GPS receiver the position will also be displayed as illustrated below :-



And:-

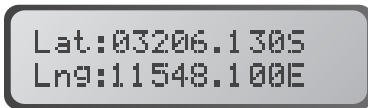

Telcall's - direct dial telephone calls

Transceivers equipped with telcall can direct dial telephone numbers and receive calls from telephone users through a Barrett 660/960 telephone interconnect system. The 660/960 is a radiotelephone interface, designed specifically for HF use. The 660/960 allows any Barrett transceiver fitted with a telcall selective calling facility to access the telephone network without operator assistance.

Note:- For telcall functions to operate the transceiver must be fitted with the selcall / telcall option and the channels enabled for selcall operation.
If ALE is in use refer to the ALE section for details on the integration of the ALE and normal selcall and telcall.



Beacon call

Channel selection is a critical factor in using the 660/960 telcall system. To enable channels to be evaluated the 660/960 telephone interconnect has a beacon facility which allows a station in an HF network to send a special selcall code that causes the 660/960 to send a beacon signal. The quality of the beacon signal received by the HF out-station is indicative of the quality of communication that can be expected on the channel in use. (refer to Selcall (selective call) section - Beacon call).

Sending a Telcall

Preset dialling

To access preset telephone numbers on the Barrett 660/960 a standard selcall is transmitted from the Barrett 950. The first two digits of the destination ID must be the same as the first two digits of the 660/960 self ID being called. The second two digits correspond to one of the 98 preset numbers stored in the 660/960 telephone interconnect.

- select the channel to be used to make the call (refer to Selcall (selective call) section - "**Beacon call**")
- listen for traffic on that channel, if no traffic then continue
- press the  key
- enter the selcall number corresponding to the preset telephone number required using the numeric keys
- press the  key
- when the selcall has finished sending, listen for reverberate tones that indicate the call was successful.
- if the call was successful then wait for a telephone connection to be made. When the call has been answered, the user can talk as normal.
- after the call is complete or the line is busy the user should hang up the line. (Refer to Selcall (selective call) section - "**Hang-up call**")

Making a call to preset telephone number 58, via a 660/960 telephone interconnect whose ID is 6099 - example

SEL
TEL

Destination ID
1234

Note:- Last selcall sent was to 1234

FREQ 6 SCAN 0 CLAR 5 MODE 8



Destination ID
6058

CHAN
SEND

Sending 6058
Selcall

Direct dialling

To access the direct dialling facility of the Barrett 660/960 telephone interconnect the transceiver must be fitted with telcall.

- select the channel to be used to make the call (refer to Selcall (selective call) section - "**Beacon call**")
- listen for traffic on that channel, if no traffic then continue
- press the  key
- enter the 660/960 destination ID using the numeric keys
- press the  key
- enter the telephone number to dial using the numeric keys
- press the  key
- when the telcall has finished sending listen for reverte tones that indicates the call was successful.
- if the call was successful then wait for telephone connection to be made. When the call has been answered, the user can talk as normal.
- after the call is complete or if the line is busy the user should hang up the line. (refer to Selcall (selective call) section - "**Hang-up call**")

Making a direct dial call to telephone number 61894341700, via a 660/960 telephone interconnect whose ID is 6099 - example

SEL
TEL

Destination ID
1234

Note:-Last selcall sent was to 1234

FREQ 6 SCAN 0 TX FREQ 9 TX FREQ 9

Destination ID
6099

SEL
TEL

Enter Phone No.

FREQ 6 CHAN 1 MODE 8 TX FREQ 9 CHAN 4 FREQ 3 CHAN 4

CHAN 1 SCRAM 7 SCAN 0 SCAN 0

Enter Phone No.
61894341700-----

CHAN
SEND

Sending 6099
Telcall



Last number redial

To use the last number redial facility press the  key twice, the last telephone

number sent will now be displayed, now press the  key and the telcall sequence will be re-sent.

Hang-up call

When a call has been completed the caller must "**hang up**" by sending a "hang up" code to the Barrett 660/960.

- press the  key
- enter the selcall ID of the 660/960 being called, using the numeric keys
- press the  key
- when the hang-up selcall has completed transmitting, listen for hang-up revertive signal, confirming the "hang up" was successful, if not heard repeat the above procedure.

Hanging up call to a 660/960 with ID of 6099 - example

SEL
TEL

Destination ID
6099

PROG
END

Sending 6099
Hang Up Call

Scanning channels

The Barrett 950 can be programmed to scan up to 450 channels. Pressing the scan key initiates scanning. Only channels that have been enabled will be scanned. Holding the scan key down for 2 seconds or more will allow the user to select which scan table is to be scanned. Use the scroll keys to select the scan table required then press the scan key again to select it.

Selecting scan table one and initiating scanning - example

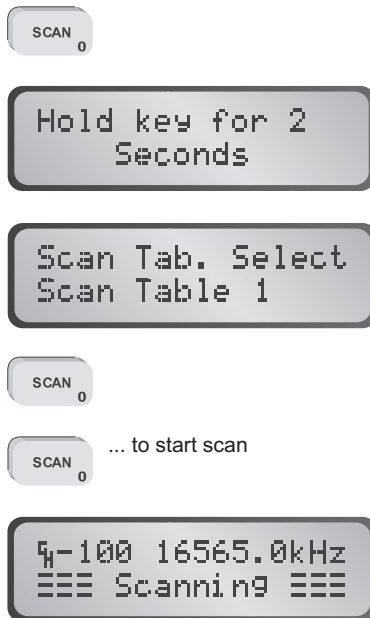

To abort scanning press PTT or any other key other than the scan key.

Halting scan

The Barrett 950 will halt scanning for the following reasons:-

- The channel has selcall enabled and a selcall signal is received.
- Signal strength level mute is selected and a signal with a level greater than the pre-set threshold level is received.
- Audio (syllabic) mute is selected and a voice signal is detected.

Selcall Scan

When a selcall signal is detected, and the channel has selcall enabled, no matter which mute type is selected the transceiver will stop scanning and decode the selcall signal. If the selcall was decoded for this transceiver the audio alarm will sound and the following will be displayed:-

```
Selcall ID:1234
Selcall
```

If no other action is taken, i.e. the transceiver is unattended then the transceiver will revert to scan and display the following:-

```
4-100 16565.0kHz
Call Received
```

Beeping and alternating with :-

```
4-100 16565.0kHz
=== Scanning ===
```

If PTT is operated or any other key, apart from the scan key, is pressed then the transceiver will select the channel on which the selcall was received as the current working channel and allow the operator to talk to the station calling.



Signal strength scan (SSL scan)

If the signal strength mute is active and a signal with a level greater than the pre-set threshold is received the scan will halt. Scan will remain halted while the signal level stays above the preset threshold. Once the signal decreases below the pre-set threshold level, for a period greater than the scan dwell period, scanning will resume.

Voice (syllabic) scan

If the audio mute is active and the mute is opened scanning will halt. Scanning will remain halted while the audio mute is open. Once the mute closes, for a period greater than the scan dwell period, scanning will resume.

Enabling channels into scan tables in transceivers with channel programming locked out.

- Select the channel you wish to enable into the scan table.
- press the  key
- press the  key
- use the  key to select the scan table required by selecting the

symbol corresponding to that scan table. This symbol is displayed on the bottom line of the display in the 2nd character position.

 Scan table 1 enabled for this channel

 Scan table 2 enabled for this channel

 Scan table 1 & 2 enabled for this channel

No symbol in this position on the display indicates this channel will not be programmed for scan.

- press the  key to save this change

Clarifier

The clarifier is used to compensate for received signals that are off frequency.

The receiver can be clarified in steps of 1Hz to frequencies from -1KHz and +1KHz of the assigned channel frequency, depending on programming. To shift the clarifier use one of the following keys

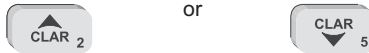

Pressing either of the above keys once will display the clarifier as follows



Release the key pressed then press it again to begin adjusting the clarifier. Holding the key down will accelerate the clarifier rate of change until maximum rate of change is achieved or the clarifier limit is reached. To clear the clarifier value, first bring up the clarifier then press the **clear** key to zero the value.

Mute types

Pressing the mute key will select the mute function required. A character indicating the mute function selected is positioned on the second line of the display at the third column from the left.

Audio (syllabic) mute



When the audio mute is enabled the mute opens only when speech is detected.

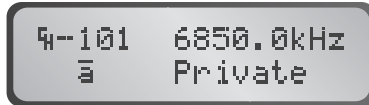

Selcall mute



When the selcall mute is enabled the mute opens after a selcall sent to the unit has been received and decoded successfully.

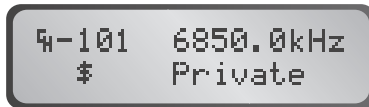

Signal strength mute



When the SSL mute is enabled the mute only opens when the received signal strength exceeds the nominated threshold level (see menu functions - "set SSL level").

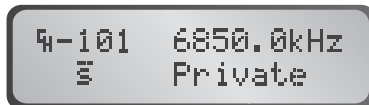

Mode selection

Mode select

The mode key selects the mode of operation eg LSB, USB, AM, CW or AFSK. The mode key will temporarily set the mode for a selected channel, until the channel is changed, or the transceiver is turned off.

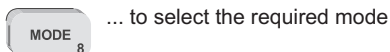

LSB mode

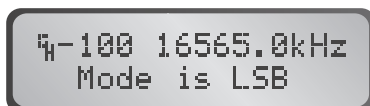

USB mode

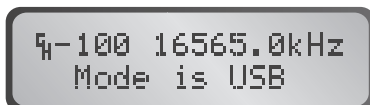

AM mode

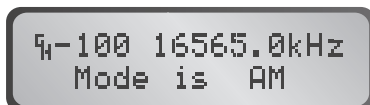

CW mode

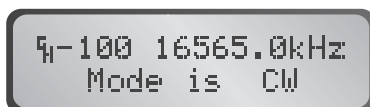

AFSK mode

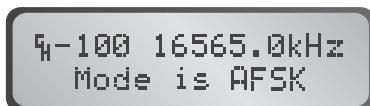

Note: If the 500Hz filter option is physically fitted and enabled in software, it will automatically be selected when AFSK mode is selected.

Alarm operation

Any channel can be assigned with either one of the following alarm signalling formats

International marine radiotelephone two-tone alarm - alternating
2200Hz/1300Hz, 500mS cycle, 50% duty cycle.

RFDS alarm two-tone alarm 880Hz + 1320Hz continuous. (Australian use only)

Testing the alarm (marine alarm illustrated)

To test the alarm encoder, select an channel programmed for alarm operation, press and release the alarm key within two seconds and the programmed alarm will be audible from the speaker.

Press  ... for less than 2 seconds

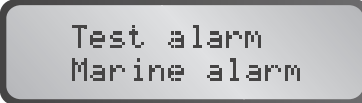

```

Test alarm
Marine alarm
  
```

Sending an Alarm

To transmit the alarm, select a channel programmed for alarm operation, hold in the alarm key for a period greater than two seconds.

Press  ... for longer than 2 seconds

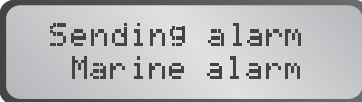

```

Sending alarm
Marine alarm
  
```

When an alarm transmit or test is attempted on a channel that has not been programmed for an alarm operation, no alarm is generated and the display is:-



```

4-100 16565.0kHz
Not an alarm chn
  
```

To cancel alarm - press any other button or key.

Scrambler

The  key toggles the scrambler on or off if the physical scrambler option PCB is

fitted and enabled in the programming section. (refer to protected programming menu - "Scrambler", and also to the Barrett PC based programming software)

To turn the scrambler on - example

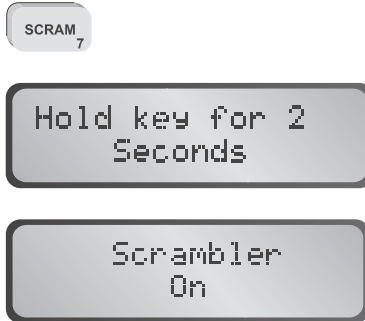

To turn the scrambler off - example

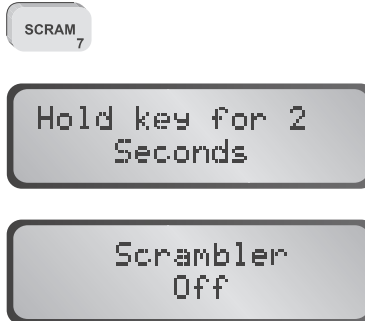

RF output power

The  key toggles the RF output power setting. The high power setting is 125 watt

PEP (voice) and the low power setting is 25 watt PEP (voice). Note:- the transceiver low power setting is sometimes set to a different value dependant on customer requirements.

Note:- If a channel was programmed for low power during channel programming the selection of high power using the method above is disabled

To select high power if low power was previously selected - example

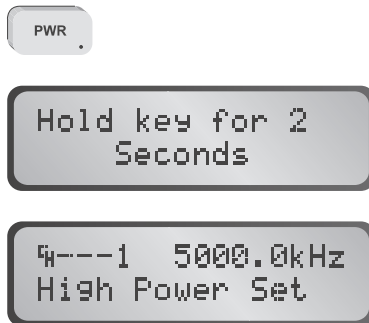

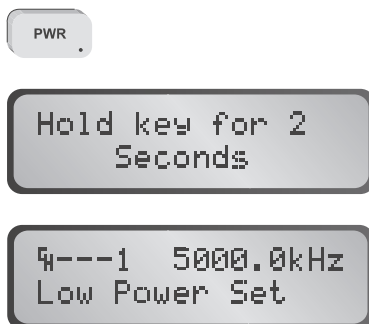

To select low power if high power was previously selected - example



The lower power symbol,  , will appear on the display.

Advanced selective call functions

Requesting another transceivers GPS position

- select the channel on which to send the call.
- listen for traffic on that channel, if no traffic is heard then continue.
- press the  key.
- enter the desired destination ID using the numeric keys
- press the  key.
- wait for the selective call to be sent.
- wait for the remote transceiver unit to send back its position data or error message. If the unit times out before the position is received an error message will also be displayed.

Making a GPS request call to station with ID 4321 - example



Once the GPS request selcall has been sent the following will be displayed:-



```
Waiting for  
a Response
```

When GPS data is received from the transceiver being requested for GPS data the display will be similar to that shown below:-



```
Lat:03206.130S  
Lng:11548.100E
```

If the transceiver being requested for a GPS position is fitted with a GPS receiver, but cannot retrieve GPS data from it (due to lack of satellite data etc), a timeout occurs in the remote transceiver and the following message will be displayed on the requesting transceiver display on receipt of the reply from the remote transceiver:-



```
No Response  
From GPS
```

If the transceiver being requested for GPS data is not fitted with a GPS receiver the following message will be displayed, on the requesting transceiver display, upon receipt of the reply from the remote transceiver:-



```
GPS Not Fitted  
in Remote Unit
```

If no response to a GPS request is forthcoming from the remote transceiver, after a fixed time period, the following message is displayed:-





```
No Response From  
Remote Unit
```

Special note:-

The transceiver being requested for GPS data will automatically respond to the request but will have no visual or audio indications noticeable to the operator or persons in the vicinity of the transceiver.

Sending your GPS position to another transceiver

- select the channel on which to send the call.
- listen for traffic on that channel, if no traffic is heard then continue.
- press the  key.
- enter the desired destination ID using the numeric keys
- press the  key.
- wait for the selective call to be sent.
- the remote transceiver unit will send revertive tones confirming its receipt of your GPS position data. If you do not hear the revertive tone, try again or try another channel and try again.

Sending your GPS position to a station with ID 4321 - example



...transceiver is loading data from its GPS receiver.

```
Lat:03206.1305  
Lng:11548.100E
```

...transceiver is sending its GPS data.

If the transceiver is fitted with a GPS receiver, but cannot retrieve GPS data from it (due to lack of satellite data etc), a timeout occurs the following message will be displayed:-

```
No Response  
From GPS
```

Pagecall

Pagecall is a system that allows messages of up to 32 characters to be sent to a Barrett 950 transceiver from a Barrett 950 transceiver connected to a PC fitted with pagecall software.

Receiving a pagecall

Upon successfully decoding an incoming pagecall an audible alarm is sounded, the mute is opened and the display shows the call as follows:-



```
Sel call ID:1234
Page Call
```

This display is held for 3 seconds then the message received is displayed:-



```
Call head office
urgent...
```

The alarm will sound for thirty seconds and then time out. To stop the alarm before the time out and acknowledge the call, activate the PTT or press any other key. If the alarm times out the display will periodically flash the "**call received**" message on the bottom line of the display.

To clear the "**Call received**" message press the clear key.

Sending a pagecall

Pagecalls are initiated through the computer control interface refer to the pagecall software instructions manual.

Status selcall (Statcall)

Statcall is a system that allows the status of any Barrett transceiver fitted with selcall to be accessed by another Barrett 950 or Barrett 940 transceiver. The status is sent from the remote transceiver as a selcall with the extra status information stored within the selcall structure. Information retrieved, that can be used for remote diagnosis of transceiver performance, is as follows:-

- Selcall ID
- Software version
- Option level fitted and radio type (950 / 940 / 930 etc.)
- Receive state battery voltage
- Last transmit state battery voltage
- Signal strength indication of received status request selcall.
- Forward power output level
- VSWR of antenna

There are two types of statcall that a Barrett 950 transceiver can receive, these are as follows:-



Status request:- when a calling transceiver has requested the status of the receiving unit.

Status revert:- where a Barrett 950 has sent out a status request and the unit called has responded by sending back the status bytes.

Receiving a status request

When the Barrett 950 receives a status request the call is not acknowledged to the user but a status revert call is automatically sent back to the calling unit.

Sending a status request

- select the channel on which to send the status request
- listen for traffic on that channel, if no traffic is heard then continue
- press the  key
- enter the desired destination ID between 0000 and 9999 using the numeric keys
- press the  key
- wait for return call containing status to be received and decoded by the 950.

Note:- All call, group call and sub-group call numbers will not return a status.

When a status selcall is received, the data is not only displayed on the transceiver display but output as a series of bytes from the RS-232 interface. (refer **Computer Control Section**)

Making a status request call to station 4321 - example



After the status request selcall has been sent the following will be displayed:-



When the transceiver requested for status has completed its return status selcall and it is received successfully the status information will be displayed as follows (to step through the status display frames faster press any key):-

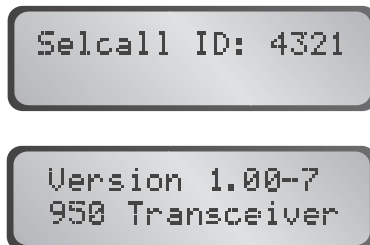

Displays version of software fitted in remote transceiver

```
RX 13.9 Volts
TX 13.9 Volts
```

Displays supply voltage to remote transceiver during receive and transmit modes.

```
SSL |>>>>>> |
FWP |>>>>>> |
```

Displays signal strength of status call received by the remote transceiver and the forward power transmitted by the remote transceiver when sending the status revert selcall.

```
Rev |>>> |
```

Displays the reverse power of the antenna connected to the remote transceiver.

If the transceiver being requested for a status does not respond the display will show the following message after a timeout period:-

```
No Response From
Remote Unit
```

Selective call history

Whenever a selcall, telcall, all call, group call, sub group call, pagecall, statcall or GPS call is received the callers' selcall ID and the channel number the call was received on are stored in the selcall history buffer. Up to twenty calls can be stored on a first in last out basis.

Accessing selcall history

Select a selcall channel

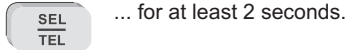

Now release the selcall key and the transceiver will be in selcall history mode. Use the general scroll keys to scroll through the available selcall history. If there is no selcall history then the following message will appear on the display:-



To abort selcall history mode activate PTT or press the clear key. If there is selcall history the top line of the display shows the channel the call was received on, the selcall ID of the calling unit and the history buffer count.

Making a call from the history buffer

To make a call when scrolling through the selcall history buffer perform the following steps:-

- select the call to be answered with the scroll keys
- press the send key

The Barrett 950 transceiver will change to the channel the logged call was received on and initiate a call sequence.

Types of selcall history

Normal selcalls, all calls, group calls and sub group calls are all displayed in the following format in selcall history :-

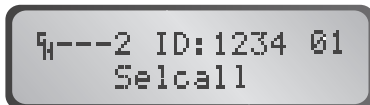

Telcalls are displayed as follows :-

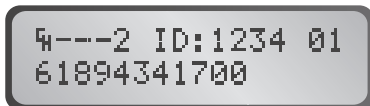

Pagecalls are displayed as follows :-

```
H---2 ID:1234 01  
Pagecall
```

SEL
TEL

... to display pagecall message:-

```
Call head office  
urgent...
```

Statcalls are displayed as follows:-

```
H---2 ID:1234 01  
Statcall
```

SEL
TEL

... to display statcall information:-

```
Version 1.00-7  
950 Transceiver
```

```
RX 13.9 Volts  
TX 13.9 Volts
```

Etc.

Tuning receiver

The 950 transceiver can be used as a tunable receiver. The receiver can be tuned in steps ranging from 1 Hz up to 10 MHz.

Entering tuning receiver mode



Tuning

To tune the receiver use the clarifier keys to position the cursor under the digit representing the frequency increment required then use the frequency up or down key to tune the receiver at the increment selected.

Tune receiver from 10000.000 kHz to 10500.000 kHz - example

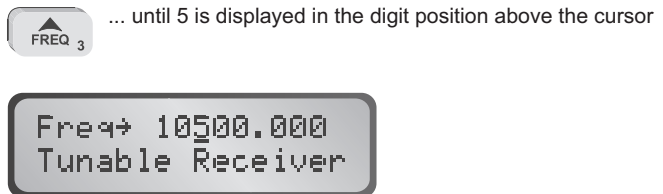
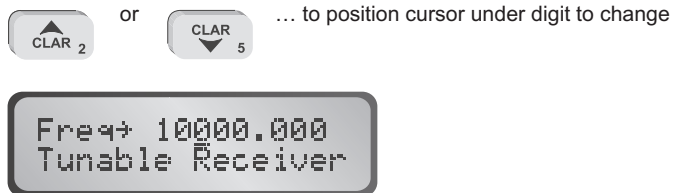

When you have finished using the tuning receiver

press the



key to return to the previous operating channel.

Scanning the tunable receiver

The Barrett 950 can scan any range of frequencies from 500 KHz to 30 MHz with a frequency step down to 1 Hz.

Setting up scan frequencies

To set up the frequency scan parameters on the Barrett 950, enter the tuning receiver mode, then:-

 ... hold down until the following is displayed:-



Enter a new frequency, using the numeric keys, to set the first scan limit boundary - example below shows Scan Limit 1 set to 12 MHz:-

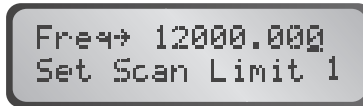

 ... until display below appears



Note:- The frequency of 12000.000 may not appear as shown above, this indicates the last scan limit boundary programmed was 12000 kHz which will not always be the case

Enter a new frequency, using the numeric keys, to set the second scan limit boundary - the example below shows Scan Limit 2 set to 30 MHz:-

```

Freq→ 30000.000
Set Scan Limit 2
    
```

PROG ... until display below appears
END

```

Freq→ 00001.000
Set Scan Step
    
```

Enter the step increment required in Hz i.e. entering 100 will select scan increments of 100 Hz.

PROG ... the display will revert to the tuning receiver display :-
END

```

Freq→ 10000.000
Tunable Receiver
    
```

SCAN ... will commence scanning using the parameters set above:-
0

```

Freq→ 10500.000
=== Scanning ===
    
```

The transceiver will halt scanning for the following reasons:

- Signal Strength Level (SSL) mute is selected and a signal with a level greater than the pre-set threshold is received.
- Audio (syllabic) mute is selected and a voice signal is detected.

Menu functions

Menus

The menu is divided into two sections, the "open menu section" and the "protected menu section". Both sections are used to set or display transceiver parameters. The "open menu section" is available directly to operators as no critical operation parameters can be changed in this section. The "protected menu section" has some critical parameters and you need a password to enter this area. The password is fixed and very simple but is used as a barrier to stop inadvertent changing of the critical transceiver parameters. It can be totally barred, if operationally required, by PC programming.



... to enter the "open menu" section



... for more than 2 seconds to enter the "protected menu" section

Use the following sequences to display or change parameters of items in the menu section.



or



... to select the menu item required to view or edit



... enters the menu item for editing.



or



... to select the parameter required.



... to save the parameter



... to exit out of the menu system

If the transceiver is left in menu mode the transceiver will, after a preset time, sound an audible alarm, flash the message "use scroll keys" and eventually time-out back to normal operating mode.

Open menu

Identification



This displays the transceiver model, software version number, the option pack fitted and the transceiver selcall ID, (if selcall is fitted) as follows :-

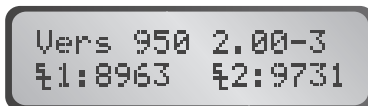

Noise blanker

This menu item allows the user to enable or disable the noise blanker on the transceiver. The noise blanker is used to reduce repetitive impulse noise.(eg vehicle ignition noise)

Select Item
Noise Blanker

Noise Blanker
Noise Blker On

... selects noise blanker on

Noise Blanker
Noise Blker Off

... selects noise blanker off

Display back-light levels

Select Item
Backlight Level

Backlight Light
Level 1 (low)

... selects display back-light intensity level 1

Backlight Light
Level 2 (Medium)

... selects display back-light intensity level 2

Backlight Light
Level 3 (Full)

... selects display back-light intensity level 3

Display back-light options

```
Select Item  
Backlight Optns
```

```
Backlight  
Short timeout
```

... selects a display back-light time out time of 5 seconds from last key press

```
Backlight  
Long timeout
```

... selects a display back-light time out time of 30 seconds from last key press

```
Backlight  
Always On
```

... selects display back-light always on.

```
Backlight  
Always Off
```

... selects display back-light always off.

Display options

```
Select Item
Display Optns
```

```
Display
RX use TX use
```

... selects the display the channel usage information in both receive and transmit.

```
Display
RX SSL TX use
```

... selects the display of signal strength level in receive and the channel usage information in transmit.

```
Display
RX use TX FWP
```

... selects the display of channel usage information in receive and the forward power level in transmit.

```
Display
RX SSL TX FWP
```

... selects the display of signal strength level in receive and forward power level in transmit.

Battery level

Select Item
Battery Level

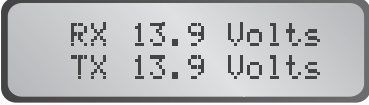

RX 13.9 Volts
TX 13.9 Volts

... the transmit voltage is the voltage recorded during the last transmit cycle, this giving a indication of the batteries capacity under load.

Protected menu

Refer to page 48 for the method of entry and the method to display or change parameters of items in this protected menu section.



Enter Password

Enter the password using the numeric keys, then press the



key.

The password is 1234. Note:- the password is published as it is only used to provide protection from making inadvertent changes to more critical parameters during normal operation of the transceiver. If no access to protected menus is to be allowed to operators, the protected menus can be barred using the Barrett PC based programming system.

RF pre-amplifier



Protected Menu
RF Preamplifier

Selects the RF pre-amplifier on or off.



RF Preamplifier
Preamp ON

... selects RF Pre-amplifier on



RF Preamplifier
Preamp OFF

... selects RF Pre-amplifier off

Note:- In later versions of 900 series transceivers this function has been removed and the RF Pre-amplifier is always switched on.

Set Scan Rate

```
Protected Menu
Set Scan Rate
```

... selects the scan rate applicable to non-selcall scan channels, selectable between 100mS and 5 seconds per channel - the example below selects 500mS.

```
Scan Rate
500ms
```

Set Scan Dwell

```
Protected Menu
Set Scan Dwell
```

```
Scan Dwell
5 Seconds
```

... selects the length of time the transceiver dwells on a channel after scan has been stopped by signal strength level (if signal strength level mute is set) or voice activity (if audio mute is set). The dwell time can be set from 1 to 10 seconds - example selects 5 seconds.

Set Signal Strength threshold Level (SSL)

```
Protected Menu
Set SSL Level
```

```
Set. SSL Level
SIG |▶▶▶▶▶ |
```

... select the level at which scan stop is activated during SSL scan. The level is set by adjusting the number of signal strength arrows on the display - example selects 5 signal strength arrows. Note:- setting this to high will prevent the mute from opening unless a very high level signal is received.

External control options

```
Protected Menu
Ext control opts
```

```
Ext control opts
BCD channel info
```

... enables the use of a Barrett 516/916 antenna select units or external devices requiring BCD coded channel information. (0000 = Channel 1, 0001= Channel 2, 0010 = Channel 3 etc to 1111 = Channel 16) **Note:-** This option disables the external alarm operation - all the options below have the external alarm enabled.

```
Ext control opts
510-910
```

... enables the use of a Barrett 510/910 Automatic Tuning Mobile Antenna.

```
Ext control opts
511-911
```

... enables the use of a Barrett 511/911 Automatic Antenna Tuner

```
Ext control opts
975 Linear Amp.
```

... enables the use of Barrett 975 series linear amplifiers.

```
Ext control opts
Aux ant fitted
```

...this feature enables the use of the optional second antenna socket that can be fitted to the rear of the 950 transceiver. When this option is selected and a jumper on the PA PCB is fitted, as described in the 950 technical manual, the transceiver receive input and transmitter output is directed to either Antenna socket 1 or Antenna socket 2 on a channel by channel basis as dictated by channel programming i.e. ANT1 or ANT2 selected.

Note:-Any antenna not requiring transceiver control can be used with the "Aux ant fitted" option. **I.e. Base station antennas, 914 manual tapped whip antennas** etc.

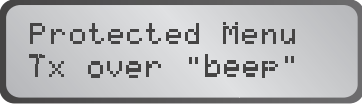
Transmit "over beep"



Protected Menu
Tx over "beep"

When this feature is selected the 950 transceiver transmits a short tone when the PTT is released. It provides an audible indication to the operator at the remote station that the station has stopped transmitting.



Tx over "beep"
On

... selects transmit over "beep" on.



Tx over "beep"
Off

... selects transmit over "beep" off.

Transmit timeout

Protected Menu
Transmit timeout

When this feature is enabled the 950 transceiver will disable the transmitter if the PTT (push to talk button on the microphone) is held on for more than 1.5 minutes i.e. if the microphone is inadvertently jammed under a seat. Releasing the PTT will reset the transmitter.

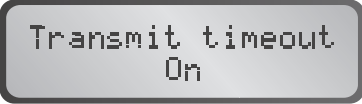

Transmit timeout
On

... selects transmit timeout on.

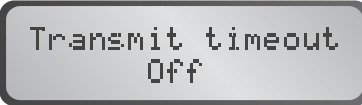

Transmit timeout
Off

... selects transmit timeout off.

Clarifier Limit

```
Protected Menu
Clarifier Limit
```

```
Clarifier
Limit: 150 Hz
```

This menu item allows the user to set the clarifier limits on land mobile channels with selective call disabled, the limits can be set from 50Hz to 1KHz - example shows the clarifier limit set to 150Hz.

Set Selcall I.D's.

Two selective call self ID's can be programmed, one is the normal ID used as the self ID on channels with Barrett standard or CCIR 493 (WA2 in Australia) format programmed. The second is used as the self ID on channels programmed for use with RDD (Radphone Direct Dial, an Australian telephone interconnected HF service)

```
Protected Menu
Set Selcall ID 1
```

... enter the selcall self ID1, using the numeric keys, for use on channels programmed for Barrett standard and CCIR 493 (WA2 in Australia) format selcall.

```
Protected Menu
Set Selcall ID 2
```

... enter the selcall self ID2, using the numeric keys, for use on channels programmed for Australian RDD format selcall.

Note:- the self ID must not be set to X000, XX00 or XXX0 as these are reserved selcall numbers for all call, group-call or sub-group-call.

Set Selcall Pre-amble

```
Protected Menu
Set SC Preamble
```

Sets the length of the selcall preamble. The length of preamble is set dependant on the number of channels being scanned. The preamble can be set from 1 to 10 seconds. Allow 500mS for each selcall channel to be scanned plus one second, E.g. to scan 8 selcall channels :- $500\text{mS} \times 8 + 1 \text{ sec.} = 5 \text{ seconds}$ - the example below illustrates a pre-amble time set to 5 seconds.

```
SC Preamble
5 Seconds
```

External alarm type

```
Protected Menu
Ext. Alarm Type
```

... selects which type of alarm signal is generated on the External Alarm, pin 17 on the auxiliary connector.

```
Alarm Type
Latched
```

... selects latched alarm, the alarm output will be continuously active for 30 seconds and then turn off. This sequence will occur unless the PTT is activated or the clear key is pressed during the sequence.

```
Alarm Type
Pulsed
```

... selects the pulsed alarm, the alarm will turn on after 15 seconds and remain on for 15 seconds, then will turn off. This sequence will occur unless the PTT is activated or the clear key is pressed during the sequence.

Scrambler - hardware option enable

Protected Menu
Scrambler

...enables software control of the scrambler hardware when fitted.



Scrambler
PCB Fitted

... selects scrambler hardware PCB option fitted

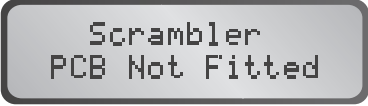

Scrambler
PCB Not Fitted

... selects scrambler hardware PCB option not fitted

Silent mode

Protected Menu
Silent Mode

This option enables or disables any audible annunciation tones associated with front panel key operation.



Silent Mode
Off

... tones enabled



Silent Mode
On

... tones disabled

GPS type

```
Protected Menu
GPS Type
```

Selects which type of GPS receiver is to be used for position information, either the internally fitted GPS receiver option Barrett P/N's BCA90030 or BCA95002 or an external GPS receiver connected to the NMEA 0183 compliant port on pins 8 and 20 of the auxiliary connector. Note:- when an external GPS is connected the functions normally associated with pin 8, linear amplifier ALC input and pin 20, auxiliary digital input are disabled and not available. Note: the external GPS receiver must be outputting the NMEA 0183 RMC sentence to be compatible with the Barrett 950.

```
GPS Select
Internal GPS
```

... selects internal GPS receiver, if the internal GPS receiver is installed

```
GPS Select
External GPS
```

... selects external GPS receiver, if an external GPS receiver is connected to the NMEA port on the transceiver's auxiliary connector.

500Hz Filter - hardware option enable

```
Protected Menu
500Hz Filter
```

```
500Hz Filter
Fitted
```

... select if 500Hz filter option is fitted to the transceiver, this will cause the hardware to select this filter in AFSK mode.

```
500Hz Filter
Not Fitted
```

... select when 500Hz filter option **is not fitted** to the transceiver.

Scan resume time

```
Protected Menu
Scan Resume Time
```

Enabling this feature, by specifying a scan resume time, the Barrett 950 transceiver will resume scanning the scan table previously selected at a time after the last key press specified by the scan resume time selected. The example below will cause the 950 transceiver to resume scanning 1 minute after the last key press :-

```
Scan Resume Time
1 min
```

Microphone Up/Down buttons

```
Protected Menu
Mic up/down keys
```

The channel up/down buttons on the microphone can be enabled or disabled using this function.

```
Mic up/down keys
enabled
```

... microphone up/down buttons enabled

```
Mic up/down keys
disabled
```

... microphone up/down buttons disabled

Cloning and programming transceivers

Protected Menu
Clone - Program

This feature in the 950 transceiver is used to copy the configuration of one 950 transceiver to another using the serial interface on the rear 25 pin "D" connector or to receive programming information from the Barrett PC based 900 series transceiver programming system.

Cloning

The following steps are necessary to copy the configuration of one 950 transceiver to another :-

- Fit the "DB25" to "DB25" cloning cable, Barrett P/N BCA90024 to the auxiliary connector on each transceiver.
- Switch on both transceivers.

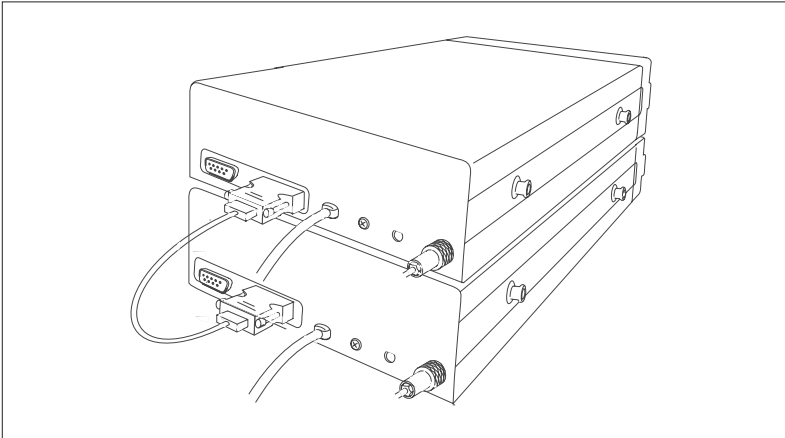

Picture of two transceivers connected together with cloning lead

On the master transceiver (transceiver containing the information to be cloned) select the cloning menu:-

```
Protected Menu  
Clone - Program
```

```
Clone - Program  
Transmit Data
```

```
Select "Receive"  
on Slave tcvr
```

Alternating with:-

```
Then  
Press any key
```

```
Sending Data  
|>>>>>> |
```

```
Transfer Done  
Press any key
```

On the slave transceiver (transceiver to receive information) select the cloning menu:-

```
Protected Menu
Clone - Program
```

```
Clone - Program
Receive Data
```

```
Waiting for Data
from Master tovr
```

```
Receiving Data
|>>>>>> |
```

```
Transfer Done
Checking Data
```

Now the two selcall self ID's of the slave transceiver must be entered:-

```
Set Selcall ID1
2543
```

Enter selcall self ID1, using the numeric keys, for use on channels programmed for Barrett standard and CCIR 493 (WA2 in Australia) format selcall.

```
Set Selcall ID2
4953
```

Enter selcall self ID2, using the numeric keys, for use on channels programmed for Australian RDD format selcall.

Note:- the self ID must not be set to X000, XX00 or XXX0 as these are reserved selcall numbers for all call, group-call or sub-group-call.

If the transfer of cloning information is unsuccessful both the master and slave transceiver will display the following:-



If this is the case the cable connection should be checked and the cloning procedure repeated.

**Programming a 950 transceiver using the Barrett PC based programming software
P/N BCA90035**

Refer to the operating manual supplied with the Barrett PC based programming software.

Remote / Local configuration

```
Protected Menu
Rem/Loc Options
```

This feature allows the Barrett 950 transceiver to be used in remote site configurations using other 900 series Barrett products such as the 972 remote site controllers and the 974 system integration system

```
Remote/Local
RX loc TX loc
```

... selects local receive and local transmit, i.e. normal transceiver operation.

```
Remote/Local
RX rem TX loc
```

... selects remote receive and local transmit, i.e. the transceiver transmits through the local antenna but the receive signal is input as an audio signal from a remote receiver through the 600 ohm balanced audio input port on pin 11 and 24 of the accessory connector on the rear of the 950 transceiver.

```
Remote/Local
RX loc TX rem
```

... selects local receive and remote transmit, i.e. the transceiver receives through the local antenna but the transmitter is disabled and transmit audio is output to modulate a remote transmitter through the 600 ohm balanced audio output port on pin 12 and 25 of the accessory connector on the rear of the 950 transceiver.

```
Remote/Local
RX rem TX rem
```

... selects both of the states above. i.e. the 950 transceiver operates as a console not as a transmitter and receiver.

BITE menu

```
Protected Menu
B.I.T.E Menu
```

The BITE menu allows the user to self test different functions of the 950 transceiver. There are four BITE functions that can be tested as illustrated below :-

```
B.I.T.E Menu
Receiver test
```

... receiver basic function test, this sets the transceiver so a known internal signal source is present in the receiver, a signal strength is recorded, the level of which is used to confirm the receiver is functioning.

```
B.I.T.E Menu
Selcall test
```

... selcall decoder test, an internally generated signal is generated in the receiver on the mark and space frequencies of the selcall decoder. The test checks that the selcall decoder output is correct with respect to the mark and space frequencies.

```
B.I.T.E Menu
Audio mute test
```

... audio mute test, an internally generated signal is generated, the test checks that the audio mute opens in response to this signal.

```
B.I.T.E Menu
SSL mute test
```

... receiver SSL mute test, an internally generated signal is generated in the receiver . The test checks that the SSL mute opens in response to this signal.

Note: The B.I.T.E. menu checks must be performed when the transceiver is connected to a dummy load. If these tests are performed with the transceiver connected to an antenna the tests may fail.

```
B.I.T.E Menu  
ALE test
```

... ALE test, if the ALE option is fitted, the test checks communications to the ALE processor.

```
B.I.T.E Menu  
RS-232 loop test
```

... RS-232 test, a plug must be fitted to the auxiliary connector with pins 2 and 3 connected together. This test checks that the RS-232 port is operational.

```
B.I.T.E Menu  
VCO lock test
```

... VCO lock test checks that the VCO remains in lock to a channel frequency of 30.5MHz

If the above tests pass the following is displayed :-

```
B.I.T.E Menu  
Test passed
```

If the tests fail the following is displayed :-

```
B.I.T.E Menu  
Test failed
```

Transceiver lock

This function enables a network operator to lock out (disable) a transceiver on the network, that for instance is being operated illegally, by sending it a special selcall (selective call) with a disable code embedded in it. The transceiver, upon receiving this selcall (selective call) is locked out (disabled). It cannot be operated again until a PIN number is entered correctly within 10 attempts. If the correct PIN number is not entered within 10 attempts, the transceiver can only be re-enabled, for normal operation, by using the Barrett PC based programming software.

To lock out (disable) a transceiver

Select the channel you suspect the transceiver to be operating on, then select the protected menu item below:-



Protected Menu
Trans Lock

MENU
STAT RQ



Destination ID
4521

... enter the selcall self ID or the transceiver to be locked out (disabled)

MENU
STAT RQ



Enter Dest. PIN
PIN:

... enter the confidential pin number of the transceiver to be locked out (disabled)

MENU
STAT RQ

... the transceiver will now be sending the "lock out" selcall.

To un-lock a transceiver

Transceivers leaving the factory are set to the default code of 0000 0000 in this state the transceiver lock feature will not operate.

On the transceiver receiving the lock out (disable) selcall the following will be displayed :-



```
Trnsvr Locked
Pin:
```

You can now enter the pin number to unlock the transceiver.
If you input the wrong PIN number more than 10 times, the following is displayed :-



```
Trnsvr Locked
Contact Dealer
```





If this is displayed the transceiver can only be unlocked using the Barrett PC based programming software.

Note:- To save time entering codes ten times before unlocking - Enter 0000 0000 the transceiver will immediately display "contact dealer"

Programming functions

950 transceivers will be delivered in a locked or unlocked state depending on local legislative requirements. If your transceiver is unlocked proceed as described below using the internal programmer, if locked you must use the 950 dealer PC based software system. 950 transceivers may however be cloned, even when locked, from each other using the cloning cable. (see cloning section)

Programming steps

- select the channel to be programmed (Operation section - direct channel change)
- press the programming key 
- enter the receive frequency, using the numeric keys.
- press the programming key 
- enter the transmit frequency, using the numeric keys.
- press the programming key 
- select first page of channel parameters, see setting first page of channel parameters below.
- press the programming key 
- select second page of channel parameters, see setting second page of channel parameters below.
- press the program key to store the new information 

Note :- The microphone PTT or clear key will abort the change.

Setting the first page of channel parameters :-

Selcall enable and format select

The  key selects the selcall format required for the channel being

programmed. Select the letter or symbol corresponding to the selcall format required. This letter or symbol is displayed on the bottom line of the display in the 1st character position.



Barrett Australia format selcall is selected.



CCIR 493 (WA2 Australia) format selcall is selected.



Australian RDD format selcall is selected.

When no letter or symbol is displayed in this position, no selcall is selected on the channel being programmed.

Scan enable

Use the scan key to select the scan table required. Select the symbol corresponding to the scan table required. This symbol is displayed on the bottom line of the display in the 2nd character position.



Scan table 1 enabled for this channel



Scan table 2 enabled for this channel



Scan table 1 & 2 enabled for this channel

No symbol displayed in this position indicates this channel will not be programmed for scan.

Low power

The  key selects the RF power setting required.

The low power symbol  will be displayed on the bottom line in the 4th character position.

when low power is selected for this channel. No symbol in this position indicates that normal high power is selected.

Channel label

Use the general scroll keys to select the required channel usage label.

Note:- the selection of available labels depends on what labels were programmed using the Barrett PC based programming software.

Alarm setting

The  key selects the alarm type required.

Select the letter corresponding to the alarm required. The letter is displayed on the bottom line in the 3rd character position.

N

No alarm selected

M

Marine alarm selected

R

RFDS alarm selected **(Australian use only)**

U

User defined alarm selected

Note:- User alarm is an option and can be programmed in the factory to customer requirements to any two tone alarm combination, if the option is not programmed this alarm defaults to the RFDS alarm.

Setting second page of channel parameters :-

Antenna Socket Select

The tune key toggles between Antenna socket 1 (ANT 1) and Antenna socket 2 (ANT2). This will only be available if the optional second antenna socket is physically fitted and enabled using Barrett PC based programming software.

Operating mode

Use the mode key to toggle through to mode required (LSB, USB, AM, CW, AFSK) as indicated in the mode section of the screen.

Programming example

Programming channel 101 to 6850.0 KHz, lower sideband, selcall enabled, entry of the channel into scan table one, low power on transmit, RFDS alarm and label 'BARRETT'. The example assumes that channel 101 was already selected by direct channel selection (see Operation section - direct channel change) and was not previously programmed.

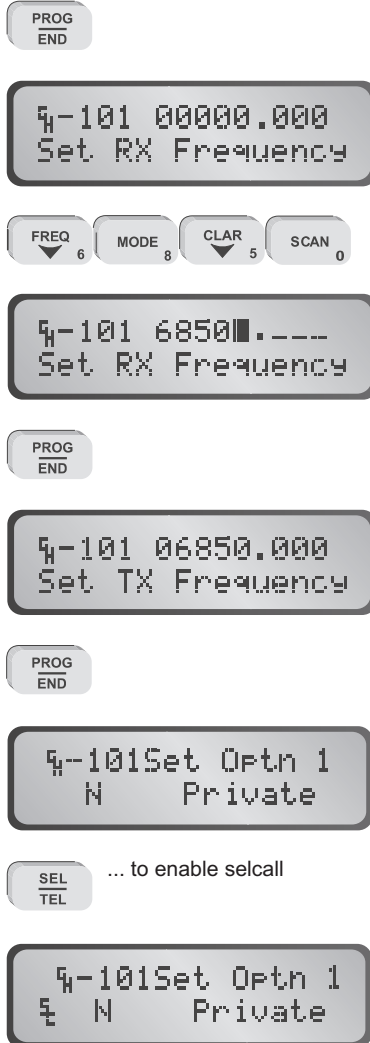

SCAN 0 ... to enable scan table one

4-101Set Optn 1
 5 -N Private

ALARM ... until 'R' is shown, to select RFDS alarm

4-101Set Optn 1
 5 -R Private

PWR to select low power

4-101Set Optn 1
 5 -R7 Private

CHAN 1 or CHAN 4 to select channel label

4-101Set Optn 1
 5 -R7 Barrett

PROG
 END

4-101Set Optn 2
 Ant 1 Mode USB

MODE 8 ... until LSB is displayed

4-101Set Optn 2
 Ant 1 Mode LSB

PROG
 END

Automatic Link Establishment - ALE - option

ALE system overview

The Barrett Automatic Link Establishment (ALE) controller option simplifies the operation of HF networks, the ALE option automating many of the procedures necessary to establish and maintain an HF link.

The Barrett ALE controller option provides complete inter-operability as required by FED-STD-1045 and U.S. MIL-STD-188-141A standards. The option is installed internally within a Barrett 950 transceiver.

HF network stations equipped with ALE controllers automatically scan a preselected set of channels, listening for ALE calls. If sounding is selected stations at random send out "sounding calls" to other stations. These signals are analysed for link quality and stored in the "sounded" stations. All stations gradually build up a table of parameters which determines best channels to use to link between specific stations. These tables are used by the ALE controller to determine the best channel to connect on when commanded by its operator to communicate with another station.

The Barrett ALE controller's powerful memory stores up to 10,000 sets of LQA information, 100 channel configurations, 20 self-address configurations and 100 other address configurations.



Operation overview

The ALE network parameters are determined by a network supervisor, this person programs all the transceivers in the network with the required addressing and channel information using the ALE fill program. This is a PC based program used to transfer pre-determined network information into each transceiver. A separate manual is provided as a guide to ALE network setup and for the operation of ALE fill program.

As ALE's prime purpose is to automate many of the procedures necessary to establish and maintain an HF link, it is only necessary for the operator to enter the station he wishes to call and activate ALE call sequence as described in the following section. There is also the facility to change some ALE parameters, this is not usually done in the field and sometimes this section is locked out. The section titled "ALE menus" describes these functions.

Commence ALE scanning

 ... key for 2 seconds

 or  ... to select the scan type required.

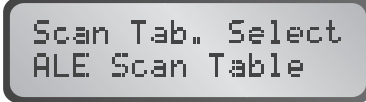

 ... to select this (ALE) scan type.

 ... to commence ALE scanning.

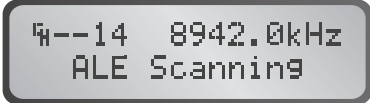

... your transceiver will now be ALE scanning and ready to accept ALE calls, receive “soundings” and transmit “soundings”, if “soundings” are enabled on your transceiver.

Whilst ALE scanning the following messages may be displayed:-



... occurs when your station receives and ALE sounding from another station in the network.



... occurs when your station transmits a “sounding”, your station would have sounding enabled.

Receiving an ALE call directed to your transceiver

```
4---5 9374.0kHz  
Tx ALE Link Data
```

... a station is calling you and you are transmitting back linking information.

```
4---5 9374.0kHz  
Linking ALE
```

... your station is now receiving more linking information from the calling station.

```
4---5 9374.0kHz  
Linked via ALE
```

... the link is successful, an audible alarm will sound after which you can start communication with the station that called you.

```
4---5 9374.0kHz  
ALE Link Failed
```

... the link was unsuccessful.

```
Not allowed  
while Linked
```

... you are linked to another station and you attempted to change channels.

Calling another ALE station

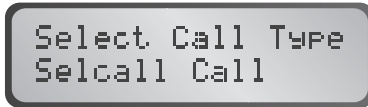

... to select ALE call.

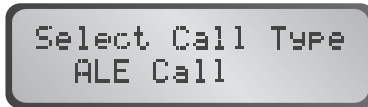

... to display the station list.

Note:- the previous two steps only occur if the channel is also programmed for CCIR-493 based selective call use, if not programmed for selective call the station list display below is selected by the first key press above:-



or



...to scroll through the station address list.

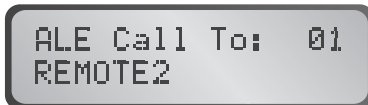

Either

MENU
STAT RQ

ALE Call From:00
BASESTATION

CHAN
4

or

CHAN
1

... select a new self ID.

ALE Call From:00
Searching

ALE Call From:01
FEILDBASE

Or

CHAN
SEND

... to this point if using the default self ID.

4---5 9374.0kHz
Tx ALE Link Data

... the ALE call sequence has commenced.

4---5 9374.0kHz
Linking ALE

... you are waiting for a response the called station.

4---5 9374.0kHz
Tx ALE Link Data

... the called station has replied and you are acknowledging.

4---5 9374.0kHz
Linked via ALE

... you now have a link established with the station you are calling.

The following error messages may be displayed:-



4---5 9374.0kHz
ALE Link Failed

... the link attempt failed.



Cannot Call
Null self ID

... when selecting a self ID you selected a self ID that is not programmed, a null ID.



Cannot Call
No channels avlb

... no channels are programmed for the station you are attempting to call.



Link rejected by
called station

... the station you called rejected the link attempt.

Making an telephone call via an ALE equipped Barrett 960 telephone interconnect

SEL
TEL

Select Call Type
Selcall Call

CHAN
▼ 4

... to select ALE call.

Select Call Type
ALE Call

SEL
TEL

... to display the station list.

Note:- the last two steps only occur if the channel is also programmed for CCIR 493 based selective call use, if not programmed for selective call the station list display below is selected by the first key press above:-

ALE Call From: 00
BASESTATION

CHAN
▼ 4

or

CHAN
▲ 1

...to scroll through the station address list.

ALE Call To: 00
Searching

ALE Call To: 01
REMOTE2

Either

MENU
STAT RQ

ALE Call From:00
BASESTATION

CHAN 4 or CHAN 1 ... select a new self ID.

ALE Call From:00
Searching

ALE Call From:01
FEILDBASE

Or

SEL TEL ... to this point if using the default self ID

ALE Phone Number

FREQ 6 CHAN 1 MODE 8 TX FREQ 9 CHAN 4 FREQ 3 CHAN 4
CHAN 1 SCRAM 7 SCAN 0 SCAN 0

ALE Phone Number
61894341700_

CHAN
SEND

4---5 9374.0kHz
Linking ALE

... the ALE call sequence has commenced.

```
4---5 9374.0kHz  
Tx ALE Link Data
```

... you are transmitting linking information to the called station.

```
4---5 9374.0kHz  
Linked via ALE
```

... you now have a link established with the station you are calling.

The following error messages may be displayed:-

```
4---5 9374.0kHz  
ALE Link Failed
```

... the link attempt failed.

```
Cannot Call  
Null self ID
```

... when selecting a self ID you selected a self ID that is not programmed, a null ID.

```
Cannot Call  
No channels avlb
```

... no channels are programmed for the station you are attempting to call.

```
Link rejected by  
called station
```

... the station you called rejected the link attempt

Closing an ALE link

```
PROG  
END
```

```
Transmitted the  
link shutdown
```

... your station closes the link

```
4--14 8942.0kHz  
ALE Scanning
```

... your station resumes scanning (if you were in scanning before the ALE link).

If the station you are linked to closes the link the following will be displayed:-

```
4---5 9374.0kHz  
Link Terminated
```

... remote station closes link.

```
4--14 8942.0kHz  
ALE Scanning
```

... your station resumes ALE scanning (if you were in scanning before the ALE link).

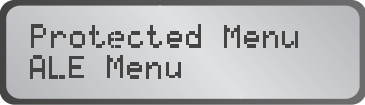
ALE menus

Protected Menu
ALE Menu

This option enters the ALE menu system. The ALE controller option Barrett P/N BCA95001 or BCA95002 must be fitted before the ALE system will operate.

If the ALE option has not previously been enabled the following will be displayed :-



ALE Menu
Enable ALE

Pressing the menu key will enable the ALE controller. The next time you enter the ALE section the first display will be as indicated below :-



ALE Menu
Factory Default

This will now appear when ever you enter the ALE menu as it is the first menu item.

ALE default

This option is to reselect factory defaults within the ALE processor. The following screen is displayed:-

```
ALE Menu
Factory Default
```

```
Restoring
System Defaults
```

Sounding On/Off

```
ALE Menu
Sounding
```

This option switches sounding on and off. When sounding is switched off, your transceiver no longer send or receives ALE sounding signals, and cannot update its information on network link analysis. For correct ALE operation, sounding should be left on all the time.

Note :- If ALE silent mode is selected on, the sounding On/Off option setting is ignored and your station does not send or receive ALE sounding signals.

```
ALE Sounding
Sounds On
```

... selects sounding on

```
ALE Sounding
Sounds Off
```

... selects sounding off

```
ALE Sounding
Chan. Dependent
```

The ALE select "Sounds Off" Or "Sounds On" on a channel basis determined by the way the channel was programmed by the Barrett ALE PC based fill program.

Link quality decay time

```
ALE Menu
LQA Decay Rate
```

This option sets the artificial decay time for the link quality information that is stored in the link quality table within the ALE processor.

The decay can be disabled or set to between 1 and 8 hours.

Switching the sounding off and setting a decay time of two hours would result in the record of a perfect channel (100% channel quality) decaying to an unusable channel (0% channel quality) over a period of two hours.



```
LQA Decay Rate
2 Hours
```



```
LQA Decay Rate
Decay Disabled
```

Sounding Signal Length



ALE Menu
Tx Sound Length

This option sets the length of the sounding transmission, in seconds, for each channel in the scan group.

When an ALE station sends sounding signals, a separate signal is transmitted for each channel in the scan group. The ALE station sends these signals sequentially. The total length of the sounding transmission is the product of the sounding signal length and the number of channels.

If the sounding signal length is set to 10 seconds and the scan group contains seven channels, the ALE station takes 70 seconds to complete sounding transmission.

The default sounding signal length is the minimum setting (under five seconds). The maximum setting is 100 seconds.



Sound Length
20 Seconds



Sound Length
Auto

Bit Error Rate (BER) threshold

```
ALE Menu
BER Threshold
```

This option sets the value of the BER threshold used in the BER testing routine.

The value can be set in the range 0 to 48.

BER testing is a method of error detection for ALE word transmission. ALE stations send and receive ALE link controlling information in blocks of data called ALE words. An ALE word consists of a 3-bit preamble and a 21-bit data field.

The result of BER error testing is used as part of the decision process to determine if an ALE link can be established using the current channel.

The higher the BER value of a transmitted ALE word, the greater the error. A BER value of 0 indicates perfect reception of an ALE word. The maximum BER value of 48 indicates that all bits of the ALE word were bad.

If a received ALE word contains more errors than the BER Threshold, the ALE processor rejects the word.

```
BER Threshold
  42
```

Golay threshold

```
ALE Menu
Golay Threshold
```

This option sets the value of the Golay threshold used in Golay testing.

Golay testing is an additional method of error detection for ALE word transmission. The result of the Golay testing is used as another part of the decision process to determine if an ALE link can be established using the current channel.

The higher the Golay value calculated for a received ALE word, the greater the error.

The value can be set between 0 and 4.

```
Golay Threshold
  1
```

Bad word count

```
ALE Menu
Bad Word Count
```

This option sets the maximum number of sequentially received bad ALE words which are allowed before the ALE processor decides that the quality of the current channel is too poor to establish an ALE link. A bad word is a word that has exceeded either the BER or Golay Threshold.

The value can be set between 0 and 4.

If the test fails during the process of establishing the ALE link, the call aborts and the transceiver returns to scan mode.

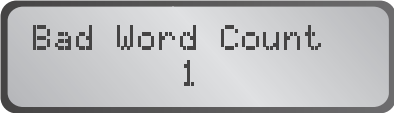

```
Bad Word Count
1
```

Call Retry Limit

```
ALE Menu
Call Retry Limit
```

This option controls the number of times the ALE station tries to establish an ALE link using each channel in turn from the scan group.

The limit can be set between 0 and 98. If 99 is selected this is interpreted as "no limit".

On each selected channel, two attempts are made to establish a link before going onto the next preferred channel, where two more attempts are made and so on, until all channels in the scan table have been tried (unless a link is established).

The sequence is then repeated dependent upon call retry limit set above.

Note: Retry duration can be made up to one minute per channel.



```
Call Retry Limit
19
```

LQA averaging

```
ALE Menu
LQA Averaging
```

This option sets the method used to update an existing link quality value stored in ALE processor memory when the new link quality value is worse than the stored value.

The option can be set to :-

- replace the old values with the new values
- replace the old values with different weighted averages of the old values and new readings.

Averaging reduces the effect that one bad reading might otherwise have on a perfect channel. If a new reading is better than an old value, the old value is replaced by the reading. There are different averaging formulas available as indicated below :-

```
LQA Averaging
((3xOld)+New)/4
```

Averaging formula 1

```
LQA Averaging
((7xOld)+New)/8
```

Averaging formula 2

```
LQA Averaging
(Old+New)/2
```

Averaging formula 3

```
LQA Averaging
No Averaging
```

Replace the old values with the new readings

ALE silent mode

```
ALE Menu  
ALE Silent
```

This option selects the silent mode of operation required.

```
ALE Silent  
Tx Modes Enable
```

ALE operates normally both transmitting and receiving sounds (if enabled).

```
ALE Silent  
Tx Modes Disable
```

ALE transmit mode is disabled (silent mode), the ALE controller does not respond to incoming ALE calls and does not send or receive sounding signals even if sounding is switched on.

Note:- You can still make ALE calls in this mode.

```
ALE Silent  
Chan. Dependent
```

The ALE will operate as described in the mode above but only on channels programmed for Tx disable mode(silent mode) by the Barrett ALE PC based fill program.

ALE fill mode

```
ALE Menu  
ALE Fill Mode
```

This option is used to enable the 950 transceiver to accept network data from the Barrett PC based ALE fill program. Refer to the Barrett ALE fill software manual for details.

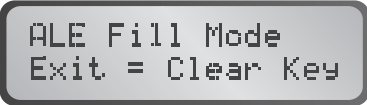

```
ALE Fill Mode  
Exit = Clear Key
```

ALE disable

```
ALE Menu  
Disable ALE
```

This option will disable the ALE option.

Installation

General

Introduction

This handbook provides instructions for the installation of land based HF communication equipment. The contents cover both base station and mobile installations.

Most of the installation work can be performed by non-technical personnel if they carefully follow the instructions given in this handbook. It is however recommended that the completed installation be checked by a suitably qualified technician. In some equipment configurations, technical adjustment is required for the equipment to operate correctly.

Note:- Some equipment has specific instructions supplied with it. When this occurs those instructions over-ride the general guidance of this handbook, and must be followed in detail.

Unpacking and inspection

When unpacking the transceiver, check the contents against the packing note provided. Before discarding the carton, check that all accessories have been removed and are not mislaid in the packing material. Inspect the equipment for any transit damage. If damage has occurred notify your supplier immediately and gain their advice on further action. Failure to do this could affect the warranty covering the equipment.

Fixed station installations

Transceiver position

The following should be considered when choosing a position for the transceiver.

Operating convenience

The transceiver should be placed so that the operator is comfortable and any facilities he may require can be easily accessed.

Air circulation

Most transceivers rely on air flow around cooling fins to dissipate heat generated by the transmitter. The mounting position must allow free air flow around these fins.

Proximity of transceiver to antenna

When using RG-58 coaxial cable from the transceiver to the antenna a cable length of no more than 30 metres is recommended. Should a run of more than 30 metres be required it is recommended that a low loss coax such as RG-213 or RG-8 be used.

It is recommended that the transceiver chassis is connected to ground using the bolt on the rear panel to stop pick-up of unwanted noise from local power supplies and electrical equipment.

Power supply

All Barrett transceivers require a supply voltage of 13.8 VDC . In most vehicles or vessels this is available from the battery, in the case of vehicles with a 24V system a 24V to 12V converter rated at 25 amps should be used (Barrett P/N BCA90014). In fixed station installations where 240/220/120/115 VAC mains power is available, a Barrett 922 power supply should be used. In base station installations where no mains is available a Barrett 901 solar power supply is available.

Note: Some installations use an AC battery charger to float charge the supply battery. Battery chargers can produce electrical noise from the rectifier diodes. This noise causes a static type of interference in the receiver. It may be necessary, therefore, to switch off the battery charger whilst the transceiver is in use. If float charging of batteries is required for installations with unreliable ac power supply, it is recommended that a Barrett 922 be used as this provides a boost and float charge facility to maintain a battery without the noise problem described above.

Voltage drop

The average current consumption of the transceiver is low but during transmission of voice peaks, high current is needed for short intervals. This means that the power supply cable must be heavy enough to supply these short duration current peaks without excessive voltage drop. Preferably use only the power cable supplied with the transceiver. If extra cable is required use a cable with a conductor square area of no less than 8mm. Unwanted voltage drop will also occur if incorrect wiring techniques such as poor choice of connection points and incorrect use of terminal lugs are used.

Protection fuse

The transceiver is provided with adequate internal protection. However, the fitting of an external fuse is considered necessary, not for protection of the transceiver itself, but to ensure that in the event of damage to the cable, a fire risk does not exist. The fuse used must be installed in the active wire as close as possible to the battery, and must be of a type which has a low voltage drop at the peak currents expected.

In-line 3AG glass fuses are not suitable. An HRC fuse cartridge rated a 25 amps 240v (Barrett P/N BCA90018) is recommended.

Antenna

The antenna is a most critical part of the complete radio installation. It must accept the output power from the transmitter, radiate that power with minimum loss and in the receive mode, accept weak signals for input to the receiver.

Incorrect antenna installations will yield poor system performance and are often the cause of complaints of poor transceiver performance.

A range of antennas is available from Barrett to suit most small fixed stations. Detailed instructions are included with each antenna.

912 Single Wire Broadband Dipoles - Barrett P/N BC91201

Barrett 912 single wire broadband dipoles are ideal for base stations that require operation on multiple frequencies through out the HF spectrum using a single antenna.

The 912 antenna can be mounted either in a horizontal or inverted 'V' configuration as illustrated in the following diagrams. In the horizontal configuration the major radiation direction is broadside to the antenna. When mounted in the inverted 'V' configuration the antenna becomes fairly omnidirectional. In the horizontal configuration the minimum distance between the masts is 49 metres and the recommended mast height is 15 metres. In the inverted 'V' configuration the recommended mast height is 15 metres and at this

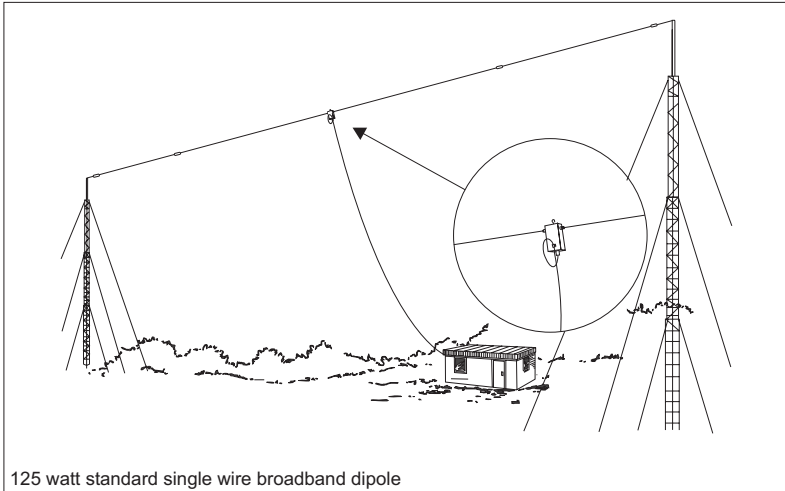

height the 2 metre stub masts are each installed at a minimum of 19 metres from the mast base. In locations with limited space the antenna can be mounted with the ends past the load resistors drooped down towards the ground. White nylon supports located just past the load resistors are provided to attach halyards for this configuration. In this configuration the minimum distance between masts is reduced to 33 metres. Support towers may be either lattice masts as illustrated, tubular telomasts or other support structures that may be available locally. It is recommended that the halyards used to support the antenna be either UV stabilised dacron chord or wire rope and that pulleys should be of stainless steel construction.

Install the antenna as illustrated in the diagrams, in the inverted 'V' configuration the eye on the top of the balun is used to attach the support halyard.

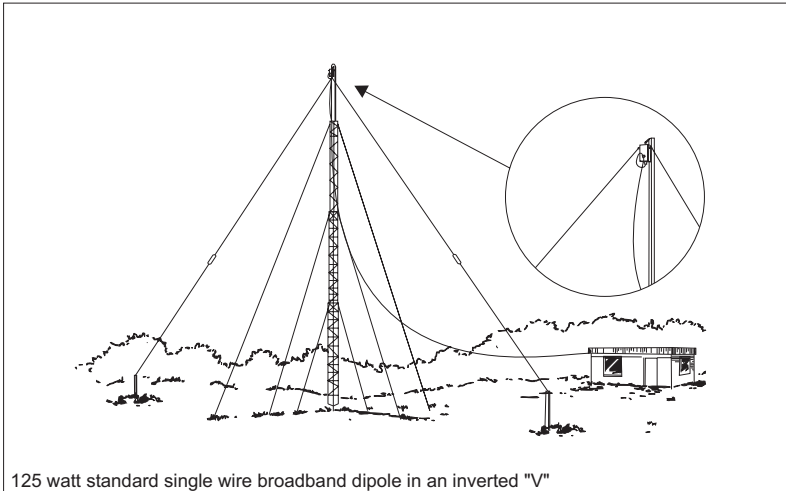

As with all antenna installations ensure the antenna is as far from sources of electrical interference as possible and in a position that makes it impossible for the antenna to come in contact with high voltage overhead mains wiring.

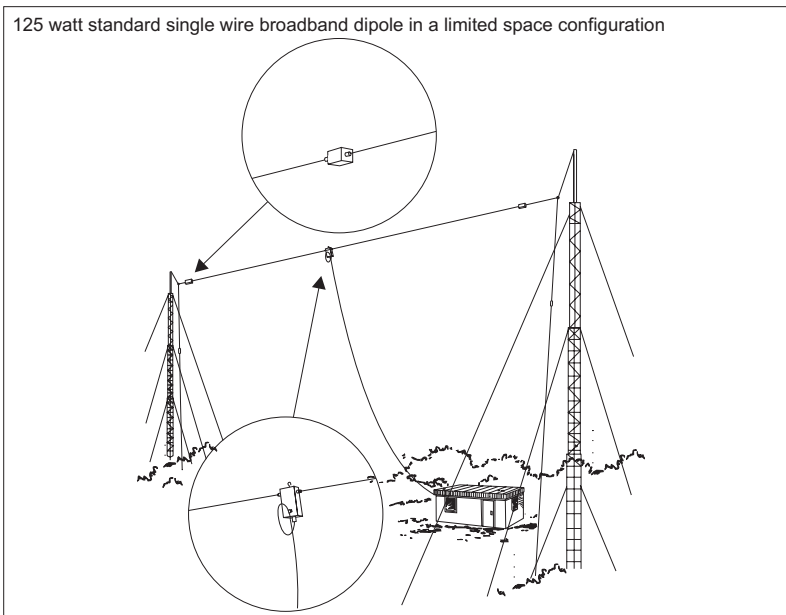

912 Multiwire Broadband Dipoles - Barrett P/N's BC91200, BC91202 and BC91203

Barrett 912 broadband dipoles are ideal for base stations that require operation on multiple frequencies throughout the HF spectrum using a single antenna.

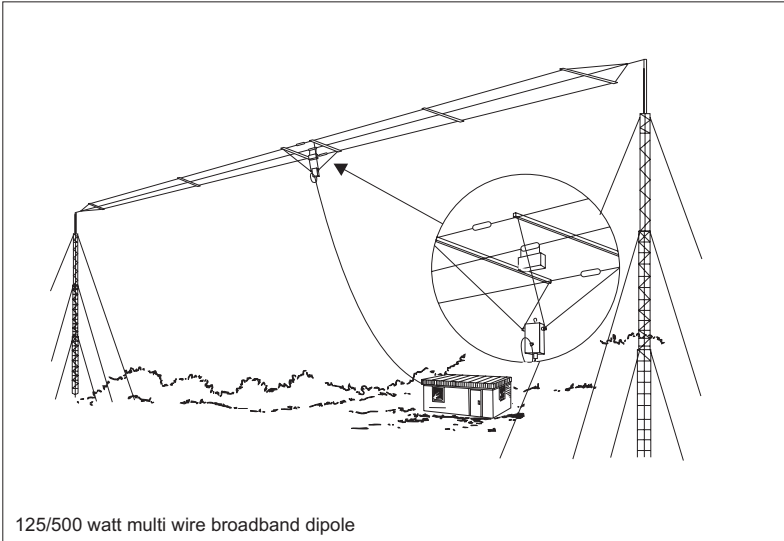

The Barrett 912 antenna can be mounted either in a horizontal or inverted 'V' configuration as illustrated in the following diagrams. In the horizontal configuration the major radiation direction is broadside to the antenna. When mounted in the inverted 'V' configuration the antenna becomes fairly omnidirectional. In the horizontal configuration the minimum distance between the masts is 32 metres and the recommended mast height is 15 metres. In the inverted 'V' configuration the recommended mast height is 15 metres and at this height the 2 metre stub masts are each installed at a minimum of 9 metres from the mast base. In this configuration the mast must have an offset or out-rigger bracket, at least 0.8 metres long, to hold the antenna away from the mast. Support towers may be either lattice masts as illustrated, tubular telomasts or other support structures that may be available locally. It is recommended that the halyards used to support the antenna be either UV stabilised dacron chord or wire rope and that pulleys should be of stainless steel construction.

Install the antenna as illustrated in the diagrams, in the inverted 'V' configuration the eye on the top of the balun is used to attach the support halyard. In the horizontal configuration the balun hangs below the antenna.

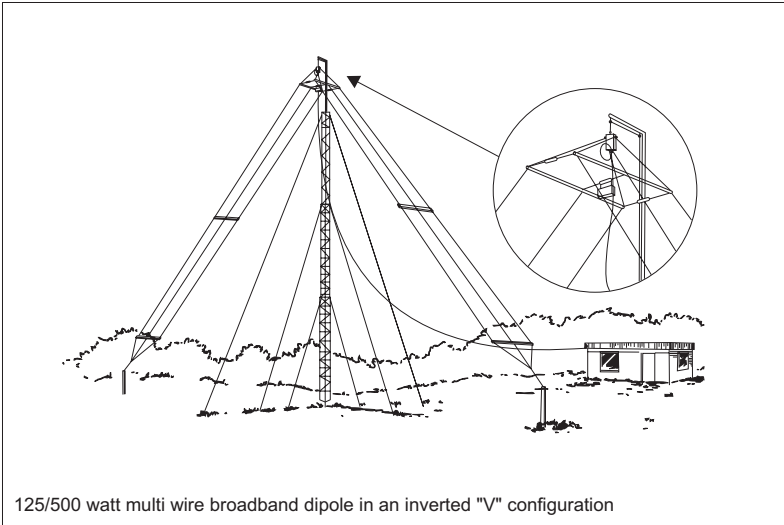

As with all antenna installations ensure the antenna is as far from sources of electrical interference as possible and in a position that makes it impossible for the antenna to come in contact with high voltage overhead mains wiring.

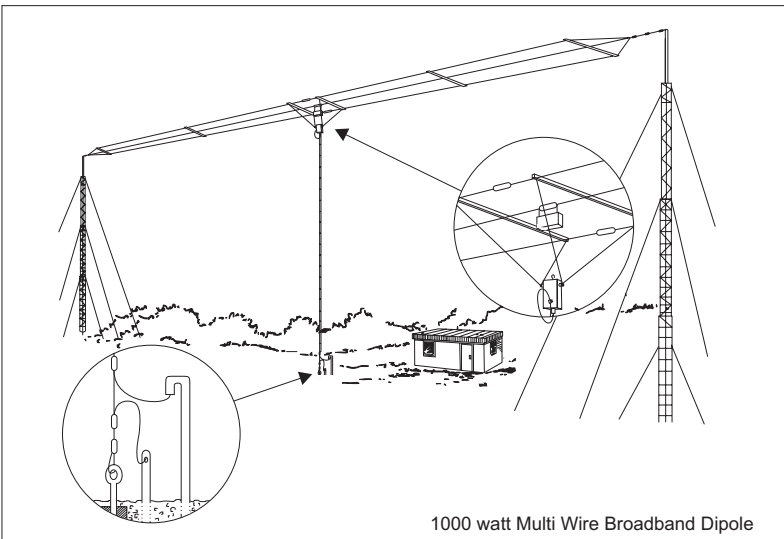

913 series helical dipoles - Barrett P/N's BC91301 to BC91305

913 series helical dipole antennas are compact and easily installed, having extremely narrow bandwidth characteristics and a performance approaching that of a wire dipole when used at frequencies over 4.5 MHz. The helical dipole antenna is fed by a single coaxial feeder and can accommodate up to 5 frequencies.

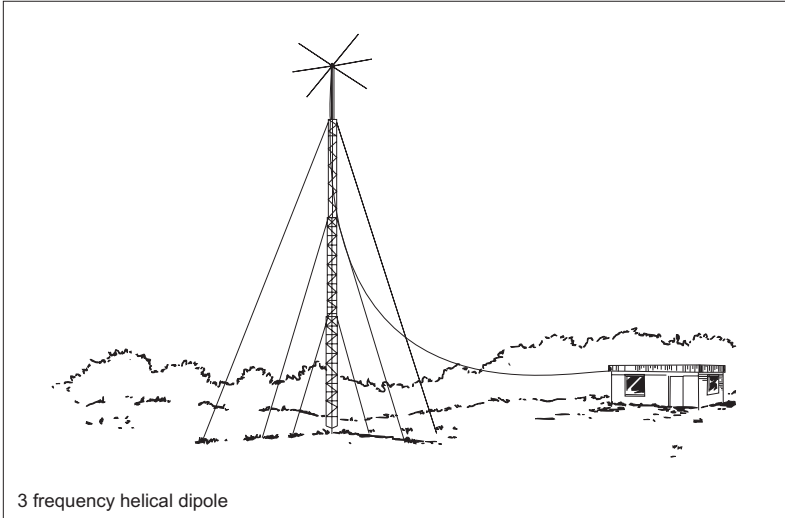

The 913 helical dipole requires a 50mm diameter mounting pole. This pole should be long enough to place the helical dipole at least 5 metres above any obstruction. Alternatively the helical dipole can be mounted on top of a mast or tower. Make sure that the site selected for the antenna is as far from any source of electrical interference as possible and that under no circumstances it can come in contact with high tension power lines.

After mounting the helical dipole hub on the mounting pole, remove the front circular cover, pass the coaxial cable through the hole at the bottom of the hub. Screw the UHF connector into the balun. Now screw the helical dipole elements onto the hub. Each element has its frequency marked on the brass ferrule used to screw the element onto the hub. Assemble the helical dipole elements in the positions on the hub as indicated by the diagram enclosed in the hub. Failure to assemble the helical dipole as indicated in this diagram will cause tuning problems.

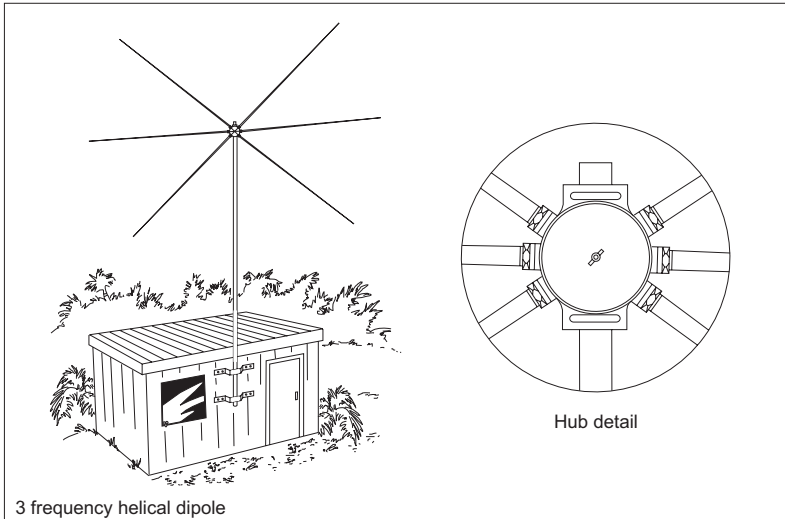

Helical dipoles are manufactured to specific frequencies, but may require fine tuning after installation. To enable this the dipole elements have an adjustable length tip to allow fine tuning for optimum VSWR during installation. Install the antenna in its final position and check the VSWR on each of the frequencies that the antenna was manufactured for. Should the VSWR be greater than 1.5:1 the antenna will require adjustment. If a tunable transmitter is available, determine on each frequency the helical dipole was manufactured for, at what frequency the best VSWR is obtained. If this occurs at a frequency below the required frequency then the tips will have to be shortened on the pair of elements corresponding to that frequency. If the best VSWR occurs on a frequency higher than the required frequency then the tips will have to be lengthened. Adjust both ends by an equal amount and repeat the above sequence until an optimum VSWR is obtained. If a tunable transmitter is not available use a method of trial and error to adjust the length of the tips, a little at a time, until an optimum VSWR is obtained. Remember always adjust each pair of elements by the same amount at each adjustment.

915 wire dipole - Barrett P/N BC91500

Single frequency wire dipole antennas, spot-tuned to the required operating frequency(s), are the most efficient antennas for use in HF base stations. They are simple to install and have a relatively narrow bandwidth.

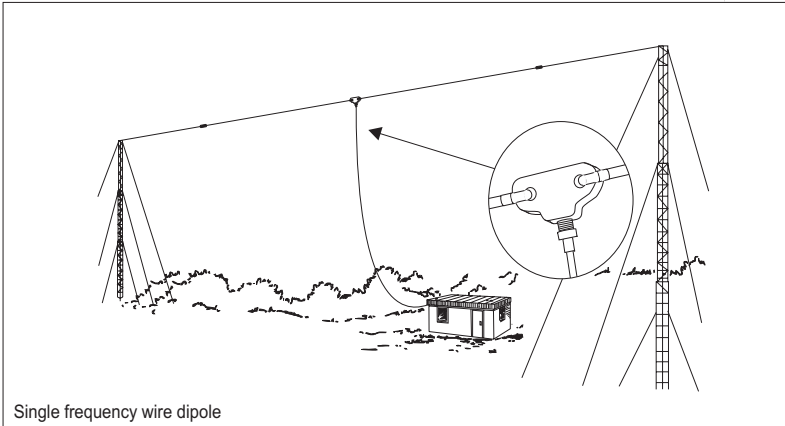

Dipole antennas should be mounted at least 1/2 wavelength from the ground. Dipoles may be mounted either between two towers or in an inverted "V" configuration (requires only one mast). As a guide, when installing the masts, the length between insulators of a half wave wire dipole is $142/(\text{frequency of dipole in MHz})$ metres. To this an allowance should be made for extra insulators and halyards.

i.e. a 3.7MHz dipole - length between the insulators = $142/3.7 = 38.38$ metres.

Wire dipoles supplied by Barrett Communications are pre-cut to a specified frequency but have adjustable ends. These adjustable ends allow fine tuning for optimum VSWR during installation. To fine tune a dipole install the antenna in its final position and check the antenna VSWR. Should the VSWR be greater than 1.5:1 the antenna will require adjustment.

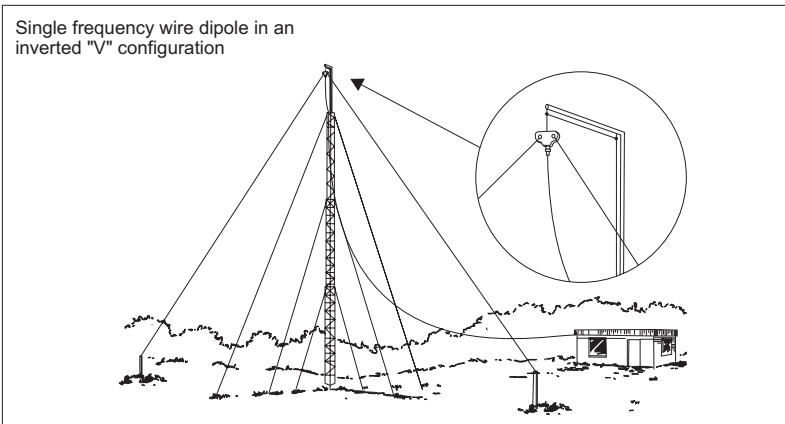

If a tunable transmitter is available, determine at what frequency the best VSWR is obtained. If this occurs at a frequency below the required frequency the dipole is too long, if it occurs on a frequency higher than the required frequency then the dipole is too short. Drop the dipole and adjust both ends by an equal amount and repeat the above sequence until an optimum VSWR is obtained. If a tunable transmitter is not available use a method of trial and error shortening or lengthening the dipole ends, a little at a time, until optimum VSWR is obtained. Remember to always adjust each end by the same amount as the other every time.

Several single frequency wire dipoles positioned between two towers.

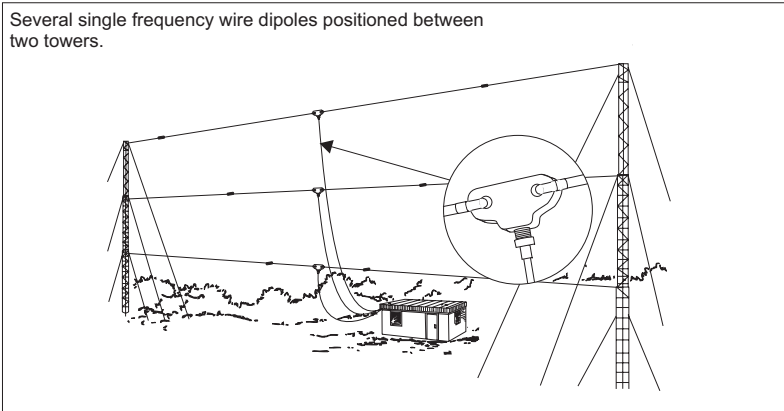

Barrett 911 Automatic Antenna Tuner for base station installations

Antenna

Various antenna configurations, such as vertical whips, long-wires and loops, can be used for base station installations, using the Barrett 911 automatic antenna tuner. In general however the following points should be considered:-

- The antenna should be mounted as far away as possible from buildings, trees, vegetation and sources of electrical interference. If metallic masts or supports are used, arrange insulators to ensure the antenna is spaced at least 2 metres from the mast. Remember the radiating part of the antenna starts at the tuner. The location of the bottom portion of the antenna is very important.
- Horizontal wire antennas have maximum radiation broadside to the antenna when the frequency is less than 1/4 wavelength. Radiation is at a minimum at the end points of the antenna. Inverted "V" installation of horizontal antennas minimises the directivity and is recommended for omni-directional coverage.
- High voltages are present on the antenna system. The antenna tuner and antenna should be located or protected so that there is no possibility of accidental contact.

Transceiver and tuner mounting

The transceiver should be mounted in a suitable position allowing easy operator access. The antenna tuner should be mounted, preferably out of the weather, and as close to the ground (earth) point as possible. The interconnect cable supplied with the antenna tuner should be routed, away from other cables, back to the transceiver and connected as indicated in the diagram. The maximum interconnect cable length should be no more than 25 metres.

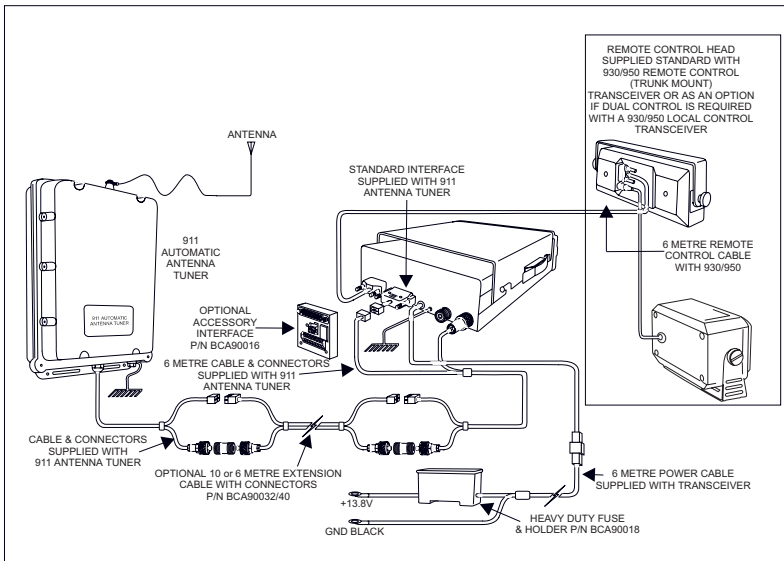

Ground (earth) system

The ground (earth) system is a key part of the overall antenna system and consequently the system operation. An inadequate ground system is the primary cause of poor performance and tuning problems. There is little point in installing the antenna unless a good ground system can be provided. In areas of good ground conductivity (ie. ground always damp), an effective ground can be made through a grounding rod. This should be approx. 3 metres in length and should be installed as close to the tuner as possible. Several rods bonded together will improve the ground contact. In some cases metal water pipes may be used as a ground providing:-

- The water pipe is close to the tuner and the water pipe enters the ground close to the tuner.
- There are no joints or couplings in the pipe that will increase the resistance path to ground.
- The water pipe enters soil with good conductivity.
- A low resistance joint is made with the water pipe.

Frequently the ground conductivity will not be sufficient to provide a satisfactory ground for the Barrett 911 tuner. This will almost certainly be the case in well drained sandy soils or on rock. In these cases a counterpoise must be used as a ground system. This will also be the case in rooftop installations where no existing ground plate (such as metal roofing exists). A counterpoise can consist of radial wires or a mesh made of materials such as chicken wire. If radial wires are used the counterpoise should consist of at least 8 to 10 radial wires, each radial being at least 5 metres in length. When radials or mesh are used at ground level it is recommended that they be buried a few centimetres below the surface.

Electrical checkout

After mechanical installation is complete select the highest frequency to be used on the transceiver. A directional watt-meter such as a bird model 43 should be inserted in the coaxial transmission line between the transceiver and the tuner. The tune mode on the transceiver is then energised (refer to the transceiver user manual). Upon application of RF energy, the tuner should start to tune, indicated by the 'clattering' of the tuner relays. After a few seconds the relay noise will cease, the transceiver should indicate a successful tune and the watt-meter reflected power should indicate a low value consistent with a VSWR of better than 2:1. Now select the lowest desired frequency on the transceiver and repeat the above procedure. The result should be the same, except that the tune cycle may take somewhat longer. If the above procedure does not give the results as indicated check that the antenna length and connections are correct and re-check all ground (earth) connections.

Note:- When received, the Barrett 911 automatic antenna tuner memory system will usually not have any pre-stored tuning information appropriate to your installation. To allow the 911 to 'learn' its tuning information simply proceed from one channel to the next allowing the normal tune cycle to take place. Each successful tune is 'memorised' so that when that channel is re-selected the tuner will almost instantaneously retune to that frequency.

Mobile installations

Transceiver position

The following points must be considered when mounting the transceiver.

Safety

It is essential that the transceiver be mounted in a place where it cannot cause injury to the occupants of the vehicle in the event of a motor vehicle accident.

For this reason overhead mounting is not generally recommended and "under dash" mounting must take into account the possibility of injuring the legs of front seat occupants.

Convenience

The chosen position for the transceiver or control head, (if a remote controlled model is used) should be one which allows convenient operation.

Positions which are often used are:

- on the transmission hump
- in place of the glove box
- behind the seat
- under the dash board (if safe)

Where a remote controlled transceiver is used, only the control head need be mounted convenient to the operator. The transceiver may be mounted under a seat, in the luggage compartment or any other out of the way place within the vehicle (which allows for sufficient cooling).

All equipment should be positioned in such a way that convenient access for maintenance is provided.

Strength

It must be assumed that the vehicle will be used on rough roads and in many cases off road. Hence mounting of equipment must take into account the severe vibration and shock that can be expected.

Transceivers may only be mounted to structural components of the vehicle body and not on dress panels or plastic interior panels. In some cases, the area around the transceiver mounting may need reinforcement.

Precautions should be taken to ensure fixing screws etc. cannot vibrate loose.

Air circulation

Most transceivers rely on air flow around cooling fins to dissipate heat generated by the transmitter. The mounting position must allow free airflow around these fins.

Obstruction

The installation of a transceiver into a vehicle should not inhibit the normal use of the vehicle. Before finally selecting equipment positions, check that normal operation of steering, foot pedals, gear change, hand brake etc. are not impeded, and that heater or air-conditioning outlets, glove box and doors are not obstructed. Always check that the drilling of mounting screw holes will not damage electrical wiring, heater hoses or hydraulic lines.

Power wiring

Connect the red positive and black negative wires from the transceiver power cable to the positive and negative terminal of the battery. Do not connect to the ignition switch or internal fuse panels as vehicle wiring to these points is of insufficient current capacity, causing voltage drop and possible noise interference. It is preferable that the control cable between the remote head and the transceiver body are run separately from the antenna coax cables and power cables. By moving these cables apart you reduce the risk of RF feedback getting into the control cable which can cause problems with the transceiver.

- Fit a suitable HRC cartridge fuse (Barrett P/N BCA90018), as near as practicable to the battery connection in the positive (red) wire.
- Route the power cable away from high tension ignition wiring.
- Secure the power cable, either to other wiring or the vehicle body, with suitable cable ties.
- Where wiring passes through bulkheads, provide appropriate protection to prevent insulation being damaged.
- Avoid excess coiling of the control cable with other cables.
- Cut power cable to exact length to avoid voltage drop.
- Ensure that you have adequate earthing on the transceiver as well as the antenna system. When mounting an antenna at the rear of a vehicle on a "swing out" type spare wheel bracket, an earth strap must be connected from the base of the antenna to the chassis of the vehicle. Do not assume that the hinge will provide an adequate earth.

Installation details - 950 transceiver and 914 series antenna

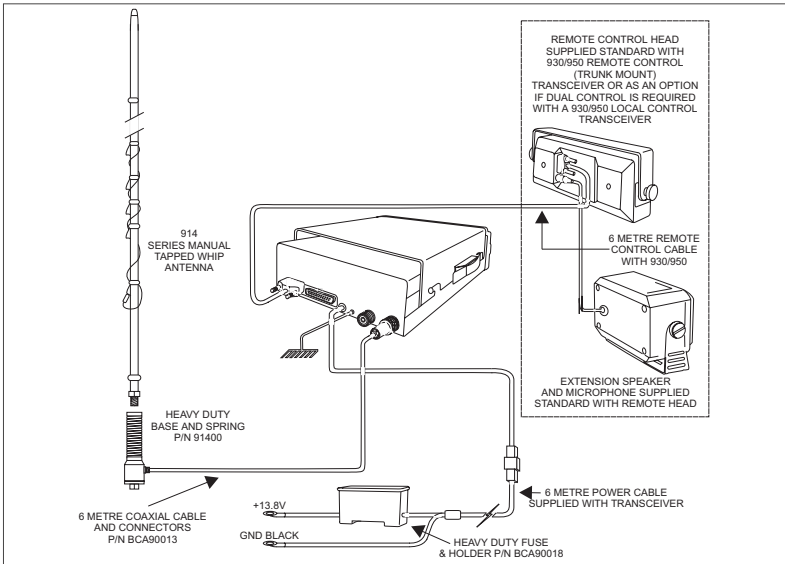

Antenna

In any radio system an effective antenna installation is essential. Because of the need to reduce the size of HF antennas so that they can be fitted to a vehicle, mobile antenna bandwidth becomes quite narrow and hence tuning is critical. In most cases the only tuning adjustment that can be effected is adjustment to position. Particular attention must be given to the antenna position if satisfactory performance is to be obtained. Refer to the instructions supplied with the antenna you have selected.

Antenna mounting

The antenna mounting must provide a strong secure anchorage for the base of the antenna. To obtain maximum radiation, the antenna base **must** be well bonded electrically to the vehicle chassis. Paint, dirt, rust, etc. should be removed from the respective fixing points. The mounting point must provide a low resistance electrical path to the main vehicle metallic structure.

Antenna feed cables

Antenna feed cables should be run (as far as possible) away from other vehicle wiring and especially away from ignition high tension wiring. Where passing through body panels or internal bulkheads, grommets must be used to protect the cables. Water-proof connectors must be used when they are outside the vehicle.

Voltage standing wave ratio (VSWR)

After installation it is recommended that the VSWR of the antenna should be measured for each channel. The instructions supplied with the antenna selected will detail this operation.

Installation details - 950 transceiver and 910 antenna

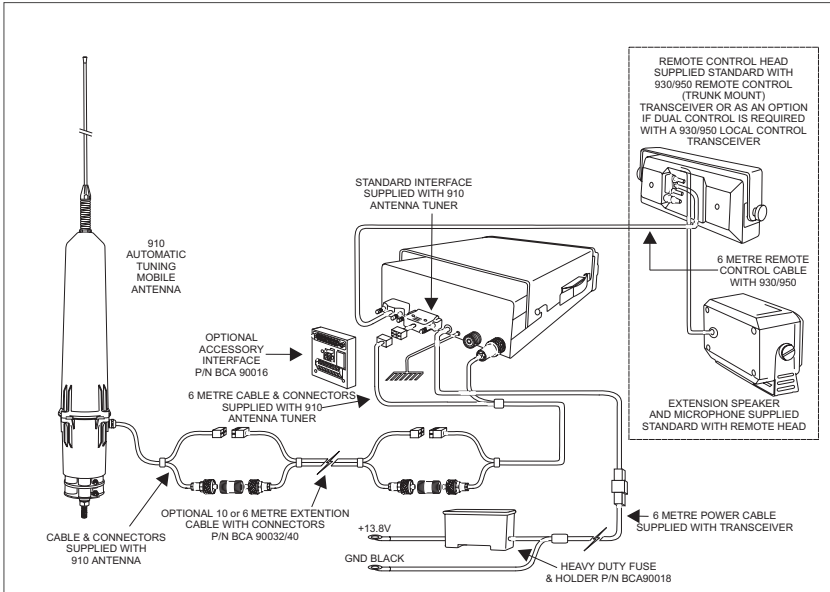

Noise suppression

Noise generated by motor or electrical accessories on the vehicle may cause objectionable interference to the received signal. This noise enters the receiver either by means of the battery leads or the antenna system. Providing that the recommendations concerning battery wiring given earlier in this book are followed, noise injected via the battery lead is unlikely to be significant. Most noise problems result from pick-up by the antenna. Practical cures involve either preventing the noise from being generated or minimising it from being radiated by the wiring connected to the noise source.

Interference suppression kit (Barrett P/N BCA90018) is available to assist in noise suppression and contains filters, suppressing capacitors, earth straps and fitting instructions.

The techniques involved in noise suppression include re-routing of wiring, screening and the use of filters. It is also necessary to maintain all electrical equipment in good working order as worn brushes, loose connections and the like, will increase the amount of noise generated.

Before attempting to cure a noise problem, the source (or sources) of noise must be identified. Ideally, there should be no difference between background noise in the receiver with motor and accessories on and that with motor and accessories off.

If a detectable difference does exist, turn off all accessories one by one until a change in noise results. Continue, noting each contributing unit until there is no detectable difference from the "all off" noise level. (For accessories such as alternator, motors, instruments etc., a wire or drive belt may have to be temporarily removed for this assessment). After identifying each noise source, they can be worked on one at a time until an acceptable level of suppression is achieved.

Another approach to this problem is to remove or disconnect all possible sources of noise then replace and suppress them in turn.

Some suggestions for suppressing particular noise sources follow:-

Ignition systems

All high tension wiring from the ignition coil through to the spark plugs should be kept as short as practicable, clean, and as close to the engine block as possible. The cable should be an impregnated neoprene resistive type and the coil must be either mounted on, or immediately adjacent to, the engine block. The low tension wire from the coil to the distributor contact breaker points must be as short as possible, and not included with other wires in a harness or loom. This wire must be shielded if more than 300mm long. Twin flex or 'figure eight' cable provides a suitable shield when connected in lieu of the original wire. This method is useful for shielding other wires suspected of radiating noise. Do not ignore the wire to an electric tachometer if one is fitted.

Coil to battery wiring

A low pass filter such as that supplied in the interference suppression kit or similar should be fitted at the coil end of this wire. The earth connection of the filter should be short and well-bonded to the coil body.

Battery charging system

The charging system circuit, consisting of either generator or alternator and a regulator may also be split into three parts:-

Alternator / generator to battery wiring

A low pass filter such as that supplied in the interference suppression kit or similar should be fitted to the main battery lead at the alternator. The filter must be rated for the maximum current available from the charging system. The earth lug of the filter should be attached to the alternator body or the engine block.

Alternator to regulator control wire (generator field wire)

This wire carries switching pulses that often contribute noise to the receiver. Suppression using capacitors or filters must not be attempted since damage to the regulator may result. Separate the wire from all other wiring, keep it as short as possible and, if longer than about 300mm it should be shielded as described above.

Other regulator wires

These are normally adequately suppressed using good low-inductance bypass capacitors. To be effective, these capacitors must connect to the wires to be suppressed and to chassis with very short leads. For this reason, the 'pigtail' style of suppressor capacitor often used with mf broadcast receivers is generally ineffective at HF.

Other noise sources

Electric motors (windscreen wipers, fans etc.)

Small electric motors can usually be suppressed with good low inductance bypass capacitors.

Engine instrumentation

Certain types of oil-pressure sensors and voltage regulators used in instrument systems contain a vibrating or thermal cycling contact. These devices can only be suppressed by isolating and screening or wiring in the same way as described for the alternator to regulator control wire. Disc ceramic capacitors with short leads (protected with insulating sleeving) are frequently useful but to prevent damage to instrument contacts, where the use of bypass capacitors is attempted, values larger than 1nf should not be used.

General noise suppression tips

When searching for sources of noise, some of their characteristics can be helpful in identification:-

- Petrol engine ignition noise and contact breaker noise is a sharp staccato 'plop' varying with engine speed. It is only with this class of noise that the impulse noise limiter incorporated within some transceivers is effective
- Noise from other sources generally has a more 'mushy' sound. That from the alternator/generator may only be troublesome over a limited range of engine speed and can also be influenced by the state of charge of the battery.
- The noise from instrument regulators may depend on the battery voltage, the reading of the instrument and the length of time the system has been switched on. For this reason, the search for noise sources must be done thoroughly to prevent noise from apparently reappearing after the installation has been completed.
- Electric motors generate a 'whining' sound. Do not forget to check windscreen wipers, electric fuel pumps, heater and air conditioning fans and other motors which operate only on an intermittent basis.

914 series manual tap whip antenna - Barrett P/N BC91401 to BC91424**Installation**

914 series manual tapped whip antennas are mounted on vehicles using a heavy duty base and spring (Barrett P/N BCA91400). The whip should be mounted on the vehicle in positions such as those illustrated in the diagrams below. A bracket, fabricated to withstand the forces and vibration that can be expected during off-road driving, should be used to mount the antenna base and spring to the vehicle. When locating the mounting position for the antenna, the ring located above the label at the bottom of the whip should be level with the surrounding ground plane, eg. the bonnet of the vehicle or the roof of the vehicle. Ensure that the mounting bolt on the base and spring is electrically bonded to the chassis of the vehicle via a very low resistance path, ie. clean all joints to bare metal and use braid earth straps if any non-metal joints are encountered. Use only good quality coaxial cable and water proof UHF connectors (such as those supplied by Barrett Communications). **Do not use PL-259 UHF connectors.**

When running the coaxial cable from the antenna to the transceiver avoid sharp corners and heat such as that generated by the manifold of the engine. After installing the antenna check the antenna VSWR on each channel. Generally if the antenna has been mounted in the positions as illustrated, the VSWR will be less than 1.6:1 and no adjustment is necessary. If the VSWR is not lower than 2:1 the antenna to ground capacitance in that installation is probably outside of the design range of the factory set tuning. Consideration may be given to retuning the whip if the VSWR is so high as to cause the transmitter ALC system to begin to reduce power (to protect the transmitter).

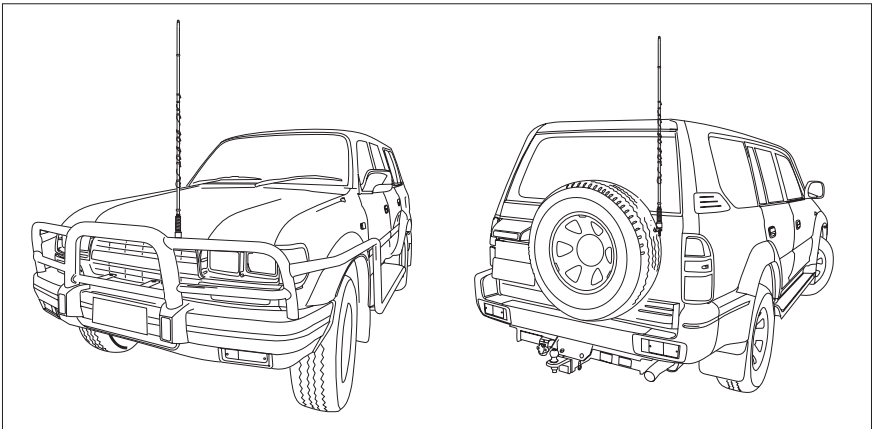

For each frequency which will not tune correctly you will need to determine whether the tuning is high or low in frequency. Generally any frequencies which will not tune will always be out the same way. When the antenna is made most frequencies are deliberately made on the low frequency side and adjusted upwards by the placement of "tuning rings". Tuning rings are single short circuit rings of 20 amp fuse wire placed on the windings of an individual part of the antenna. A tuning ring inductively raises the frequency of the section of antenna over which it is placed.

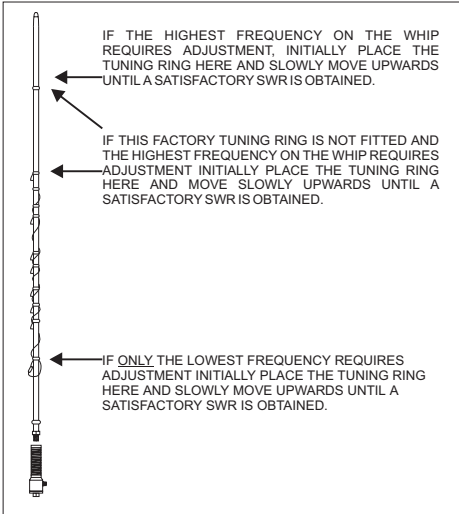

It must be understood that the tuning of an antenna on a particular vehicle or installation may not hold for other vehicles or installations. To determine whether any particular frequency tap is high or low hold the tune key down on the relevant frequency and observe the VSWR on a suitable meter. Get an assistant to slowly move his outstretched arm closer to the antenna tap in use.

If the VSWR gets better then the antenna is too high in frequency. This indicates that there is insufficient antenna to ground capacity. Usually this happens when the antenna is mounted too far away from the body of a vehicle. Either re-site the antenna closer to the vehicle or remove any tuning rings which are already on the antenna.

If the VSWR gets worse when following the above procedure then too much capacity is already present, this is frequently encountered when mounting the antenna too low on a vehicle bumper bar or when mounting close to bodywork as in cab-over type vehicles. In this case either re-site the antenna further away or add extra tuning rings to the frequency sections affected until a suitable VSWR is obtained.

Note: Truck cab-over installations usually produce distorted radiation patterns even when the VSWR looks good.

When tuning is complete any new rings added should be coated with epoxy resin to secure and protect the ring from damage. Five minute quick setting type epoxy is suitable. If rings need to be removed they may be cut off using a sharp pair of side cutters. Take care not to cut into the body of the antenna.

Note: If the wander lead is damaged or lost and requires replacing the number on the first tap eg. WI-60 indicates the length of the wander lead was 60cm. When making a replacement wander lead ensure it is made to this length to obtain optimum performance.

Operation Instructions

The 914 manual tapped whip antenna should now be screwed into the base and spring mounted on the front of the vehicle.

The **operation frequency being used on the transceiver should now be selected on the antenna**. This is done with the supplied jumper lead as indicated in the diagram below and the following example (Note:- this is an example only and your antenna will be manufactured with different frequency taps.)

The 914 manual tapped whip antenna used in the example has the following frequencies:-

Channel 1 4030 kHz	Channel 2 4760 kHz	Channel 3 5190 kHz
Channel 4 5254 kHz	Channel 5 7180 kHz	Channel 6 8199 kHz
Channel 7 9134 kHz	Channel 8 9145 kHz	Channel 9 10567 kHz
Channel 10 14567 kHz		

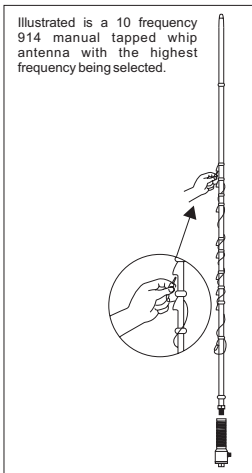

When using Channel 1, frequency 4030kHz, the jumper lead should be removed from the bottom antenna socket and stored in the vehicle.

On all other channels the jumper lead is required:-

For Channel 2 , frequency 4760kHz, the jumper is plugged into the bottom socket then wound tightly around the antenna and the other end plugged into the socket marked 4760.

For Channel 3 , frequency 5190kHz, the jumper is plugged into the bottom socket then wound tightly around the antenna and the other end plugged into the socket marked 5190.

An so on to channel 10.

Note:- It is important for correct operation of the whip antenna to have the right frequency tap selected as indicated above and that the jumper lead is wrapped tightly around the antenna between sockets.

910 automatic tuning mobile antenna - Barrett P/N BC91000

The 910 Antenna plugs directly into the rear auxiliary connector of 550/530 or 950/930 transceivers using the cables supplied. Transceivers must have the 910/510 Antenna option set during programming (refer to operation and programming manual).

A good earth (ground) to the main body of the vehicle is essential for efficient operation of the antenna. To achieve this clean all joints to bare metal and use copper braid earth straps if any hinges or non-metallic joints are encountered.

IMPORTANT INSTRUCTIONS

When fitting the whip assembly to the Barrett 910 antenna, it is important to **ensure the whip spring base is tightened firmly onto the ABS antenna body**. Barrett communications recommends turning the spring base on to the ABS body lightly by hand until it can be turned no further (ie; the mating faces of the spring base and mounting stud on top of the ABS antenna body are touching). Then using a suitable tool (ie; spanner) turn the lower threaded part of the spring base a further 20-30 degrees clockwise while holding the top of the ABS antenna body with a free hand.

Note: Failure to fit the whip assembly on the ABS antenna body correctly in accordance with the above instructions may lead to eventual failure of the whip mounting stud.

The antenna is supplied with a pre-terminated 1.5 metre cable tail. This should be routed into either the engine compartment or boot (trunk) of the vehicle.

A 6 metre pre-terminated extension cable is supplied to connect the antenna to the transceiver (this cable may be extended to 12 metres by use of another extension cable). If the joint between the antenna stub cable and the extension cable is in an exposed position, a butyl rubber self amalgamating tape should be used to seal the joint. Do not wrap this joint if it cannot be made completely water tight as water will collect in the joint and cause it to corrode.

Antenna Assembly

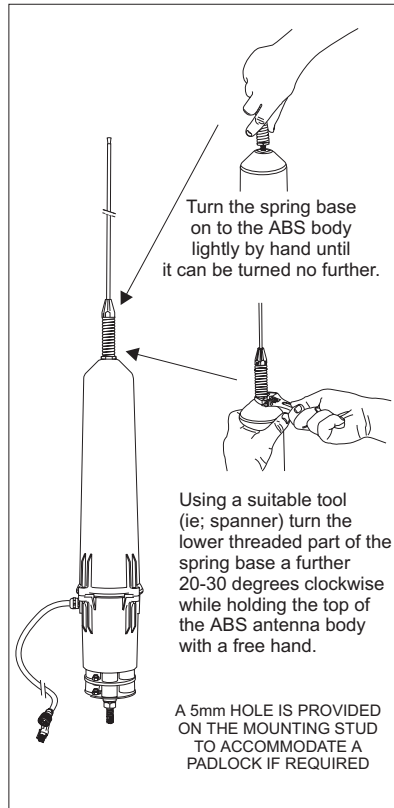

910 Antenna Testing

To test the antenna, first select the lowest transmit frequency in the transceiver and press the TUNE* key. On a 930 or 950 transceiver the display should show the words "Automatic Tuning" for a few seconds, followed by "Autotune Passed". (On a 530 or 550 transceiver the lower line of the display will indicate "SWR" and the transceiver will "beep" while the tuning is in progress, then stop beeping once the tune is successful). Repeat the above test on the highest frequency in the transceiver, and on a selection of frequencies in between at approximately 2 MHz intervals. If the tune passes at all times, the 910 is working correctly.

However, if the display shows "Autotune fail" accompanied by a series of low pitched beeps at any point, the 910 has failed tune. Check all cables are correctly connected, check the earth cable from the base of the 910 has a good connection to the vehicle body (not chassis or battery), check the whip fitted is not faulty or incorrect, and move the vehicle if the 910 is close to any metal fences, buildings etc. The 910 tunes on whip current, not SWR. If the transceiver indicates tune has passed, the system is working correctly.

*On the 550/930/950 Transceiver, press the TUNE button.
 On the 530 Transceiver, press and hold the desired channel key for more than 2 seconds.

Preferred Mounting Positions

ABSOLUTE MINIMUM CLEARANCE
TOP VIEW

160mm
BULL BAR

Important:
 Please note that the mounting of a 910 Antenna on the front of a vehicle may be considered illegal in some areas/countries. Please check with your local transport/vehicle authority prior to installation on the front of your vehicle.

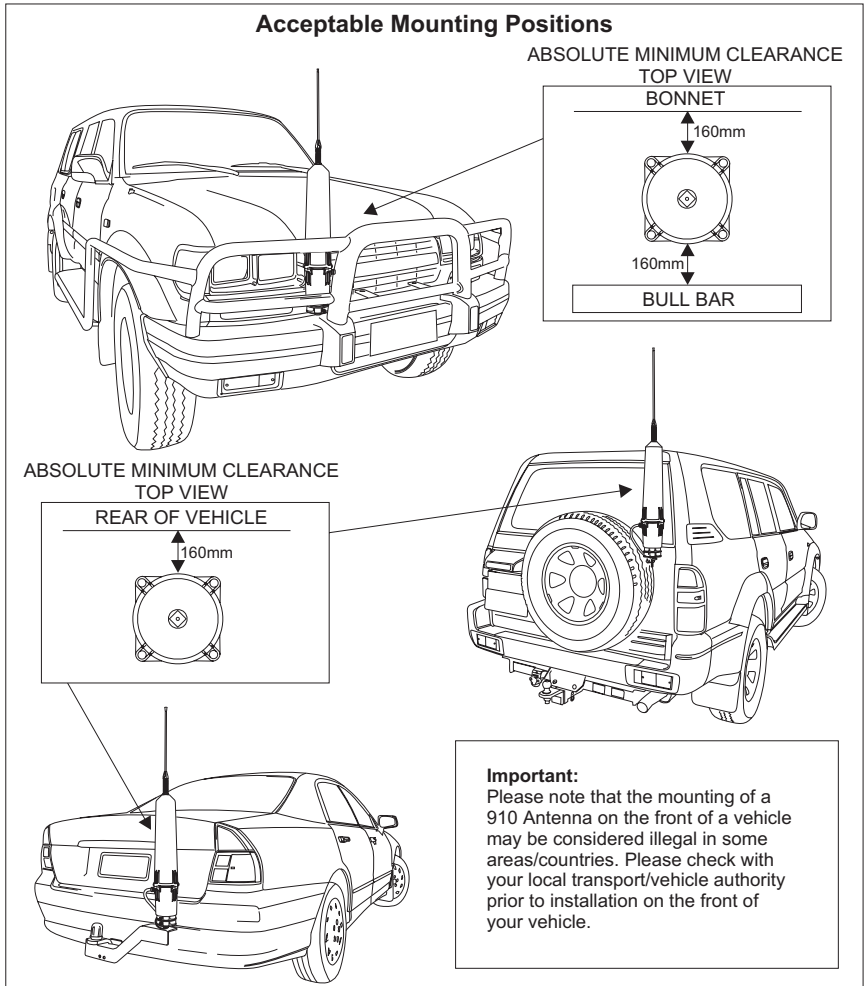

Important Information

The 910 Antenna is a high performance device that must be mounted in positions as indicated in the illustrations following. It is **ESSENTIAL** to maintain the minimum clearances between the antenna and surrounding metal work as indicated in the diagrams. **FAILURE TO MAINTAIN THESE CLEARANCES WILL NOT ONLY REDUCE THE EFFICIENCY OF THE 910 ANTENNA BUT MAY ALSO LEAD TO INTERNAL RF ARCING AND FAILURE.**

Select a position free from excessive vibration. A bracket, fabricated to withstand the forces and vibration that can be expected during off-road driving should be used to mount the antenna to the vehicle.

Caution:- Whilst the 910 Automatic Tuning Mobile Antenna is designed to with stand vibration to military type specifications on tyred vehicles, some mounting positions on large prime-movers, particularly front mounted bull-bars, are subject to vibration that far exceeds these type of specifications. Do not mount the 910 Antenna in positions such as these as damage to the antenna may result.

For operation under low clearances use the supplied plastic clip and cord to pull the antenna into a horizontal configuration as indicated in the diagram below.

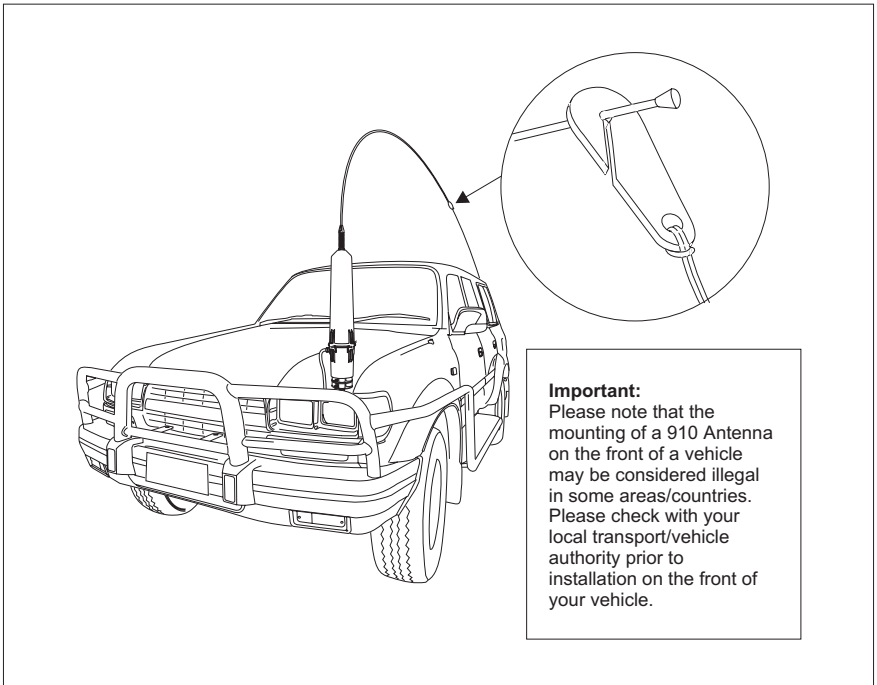

Marine Installations

General

The Barrett 911 automatic antenna tuner is designed for use in land base station and maritime HF services. Primarily designed for operation with end-fed un-balanced antennas such as whips and long wires, the tuner is built in a waterproof impact resistant, moulded ABS plastic enclosure.

Antenna selection

The 911 automatic antenna tuner will operate into almost any end-fed antenna with a length exceeding 2.5 metres, providing an effective ground (earth) is used. The antenna efficiency will be proportional to the length of the antenna and will be maximum when the length of the antenna approaches $1/4$ wavelength. It is advisable to limit the wire antenna to $1/4$ or $3/4$ wavelength at the highest frequency to be used.

Antenna

On sailing vessels the antenna can either be an insulated backstay or a whip antenna mounted vertically, usually on the stern. Best performance will be achieved by using an insulated backstay as the radiating length will be longer than that available when using a whip. The top insulator on the backstay should be approximately 300 mm from the mast and the bottom insulator should be at eye level above the deck. The distance between insulators should be greater than 10 metres and less than 35 metres. A whip antenna is generally used on small to medium sized power vessels. There are different length whips to suit the vessel length.

Transceiver and tuner mounting

Select a suitable position in the vessel to mount the transceiver. It should be a position that is out of the weather and easily accessible to the operator, whilst as close as practical to the 13.8V DC power source. Mount the transceiver to a solid fixing point using the mounting cradle. Make sure there is sufficient space at the rear of the transceiver to connect the power and antenna cables.

The antenna tuner should be mounted as close to the antenna feed point as possible. In metal vessels the length of the feeder from the antenna tuner to the feed-through insulator, inside the vessel, should be kept less than 1 metre.

The antenna feed cable should be a suitable high voltage cable. Care should be taken to avoid sharp points when terminating the cable to prevent corona discharges.

The interconnect cable supplied with the antenna tuner should be routed away from other cables back to the transceiver and connected as indicated in the diagram overleaf.

Ground (earth) system

The ground (earth) system is a key part of the overall antenna system and consequently the system operation. An inadequate ground system is the primary cause of poor performance and tuning problems. There is little point in installing the antenna unless a good ground system can be provided.

Metal hulled vessels provide an almost perfect ground. The tuner ground terminal should be connected directly to the hull using the shortest possible ground strap. The point of connection to the hull should be prepared so that it is free of paint and rust to ensure a good contact area with minimum electrical resistance.

Wooden or fibreglass vessels present more of a problem to ground. Ideally the vessel should be fitted with an external copper ground sheet, connected to the interior of the vessel by suitable stud or an earth plate ("E" plate Barrett P/N BCA91700)

If the vessel is yet to be constructed, then in the case of fibreglass vessels a thin copper sheet with an area of not less than 4 square metres should be moulded into the hull during lamination. A suitable heavy strap should be connected to the sheet and left free for earth connection.

Should neither of these methods be available it will be necessary to bond as many large metallic objects, such as the engine and propeller shaft, together to form a ground.

Whichever method is used the ground run from the ground system to the antenna tuner should be as short as possible and use copper strap at least 50mm wide (wider if available). Consideration must always be given to the problem of electrolysis. Severe structural damage may occur if electrolysis is present.

Corrosion

All connections in marine situations are subject to corrosion and oxidation. To minimise this all joints should be cleaned and have silicon grease applied before assembly. Under severe conditions joints should be protected with self vulcanising rubber tape.

Installation details - 950 transceiver and 911 antenna tuner.

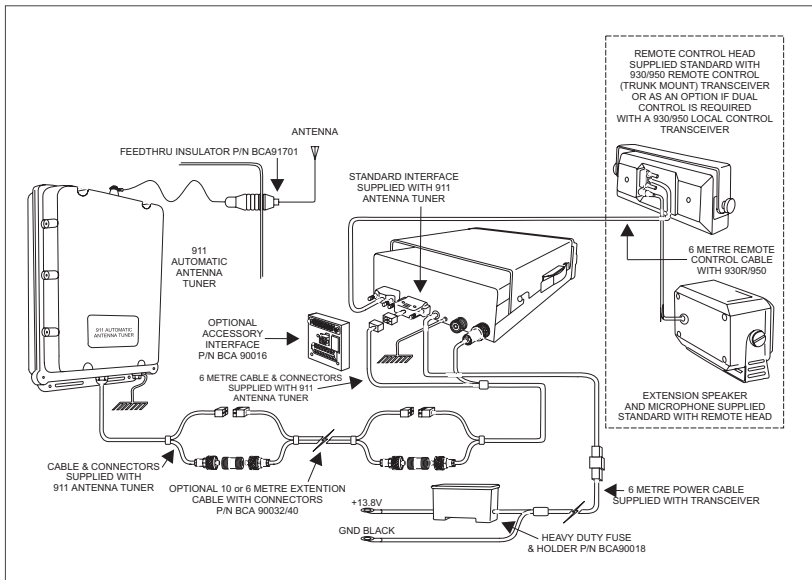

Electrical checkout

After mechanical installation is complete select the highest frequency to be used on the transceiver. A directional watt meter such as a Bird Model 43 should be inserted in the coaxial transmission line between the transceiver and the tuner. The tune mode on the transceiver is then energised (refer to the transceiver user manual). Upon application of RF energy, the tuner should start to tune, indicated by the 'clattering' of the tuner relays. After a few seconds the relay noise will cease. The transceiver should indicate a successful tune and the watt meter reflected power should indicate a low value consistent with a VSWR of better than 2:1. If the cover of the tuner is removed the PCB mounted 'tuned' LED should be illuminated. Now select the lowest desired frequency on the transceiver and repeat the above procedure. The result should be the same, except that the tune cycle may take somewhat longer. If the above procedure does not give the results as indicated check that the antenna length and connections are correct and re-check all ground (earth) connections.

Note:- When received, the Barrett 911 automatic antenna tuner memory system will usually not have any pre-stored tuning information appropriate to your installation. To allow the 911 to 'learn' its tuning information simply proceed from one channel to the next allowing the normal tune cycle to take place. Each successful tune is 'memorised' so that when that channel is re-selected the tuner will almost instantaneously retune to that frequency.

Portable Operation

For temporary base station operation the Barrett 950 can be operated from batteries using either a single wire, end fed, portable broadband antenna Barrett P/N BC91204 or a tactical rapid deploy dipole, Barrett P/N BC91502 as illustrated below:-

End fed single wire broadband used in a typical temporary base station:-

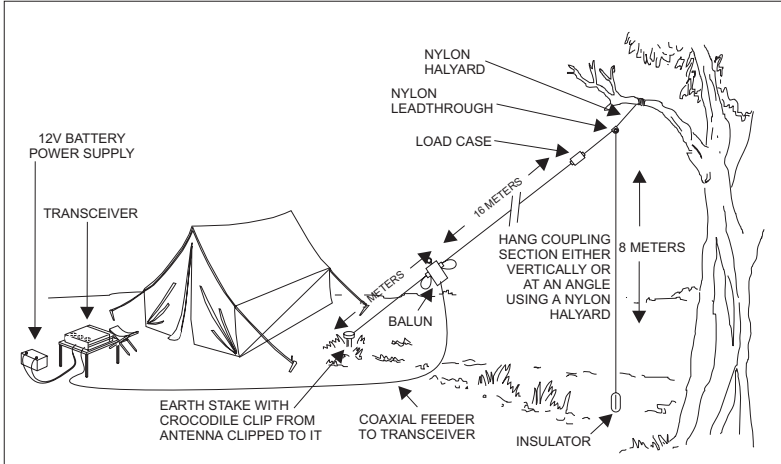

Tactical rapid deploy tuned dipole:-

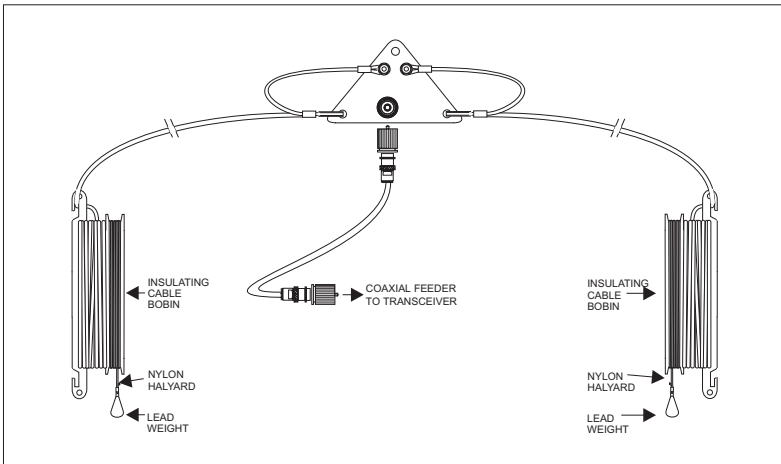

Inverted "V" Configuration

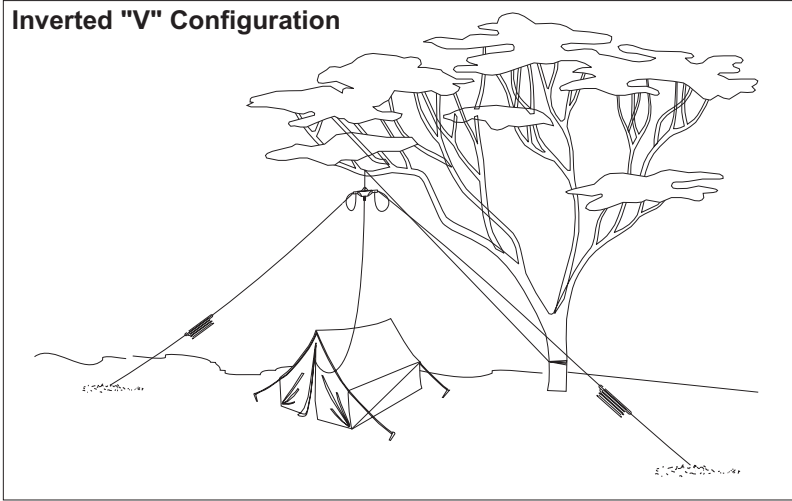

Sloping Configuration

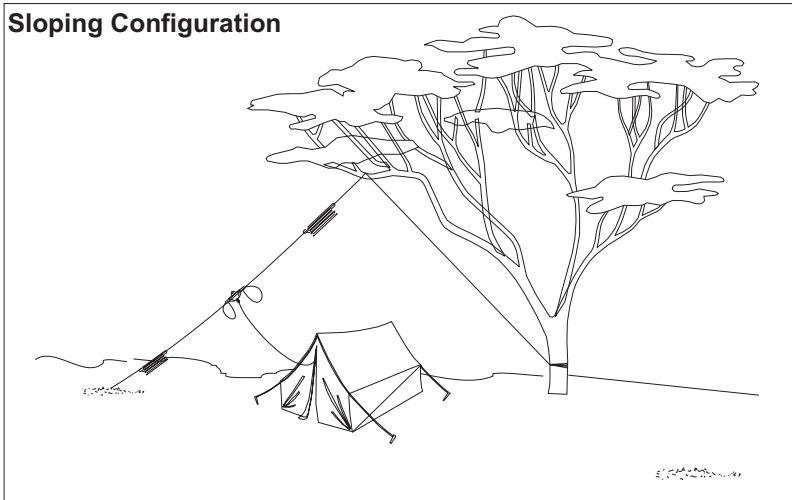

Auxiliary connector

(25 pin female "D" connector on rear panel)

Pin	Name	Description of function	Level
1	Ground	Ground	0V
2	Rx Data	RS-232 data input	True RS-232
3	Tx Data	RS-232 data output	True RS-232
4	External Power On	For use with Barrett 960 or ancillary equipment.	Low to activate
5	External Speaker	External speaker output	0-10V
6	Tuned In	Antenna tune cycle complete input from 910 / 911	Low going pulse
7	RS-232 Gnd.	RS-232 Ground	0V
8	ALC / Ext. GPS In	Ext. ALC from Linear Amp / Ext. GPS Input (with pin 20)	0-10V / NMEA 0183
9	Auxiliary PTT In	Auxiliary PTT input	Low to activate PTT
10	Scan Stop	Scanstop input from external modem	Low to stop scan
11	Bal. Tx Audio In	Balanced external Tx audio input (with pin 24)	600 Ohms 0dBm.
12	Bal. Rx Audio Out	Balanced un-muted Rx audio output (with pin 25)	600 Ohms 0dBm.
13	Ground	Ground	0V
14	Ant 0 / Pre-amp on	Channel no. output Octal bit 0 / 910 pre-amp on - Note 2	Active low
15	Ant 1	Channel no. output Octal bit 1 - Note 2	Active low

Pin	Name	Description of function	Level
16	Ant 2	Channel no. output Octal bit 2 - Note 2	Active low
17	External Alarm Out /Ant 3	Horn / Latched alarm out (selcall activated) / Ant 3 - Note 2	Active low
18	13.8 V Int Out	Interrupted 13.8 V for 910 Auto. Antenna	13.8V-0V / Active Low
19	Ant 0 / Pre-amp on	910 pre-amp on / Channel number output Octal bit 0 - Note 2	Active low
20	Aux. dig. input / Ext. GPS in	Aux. dig. input / Ext. GPS Input (with pin 8)	Active low / NMEA 0183
21	PTT / C-Mute Out	PTT Out / Receiver Cross Mute Out	Active low
22	CW Key	Input from CW Key	Low to activate
23	+13.8 V Fused Out	+13.8V Output to power auxiliary equipment	13.8V @ 2 Amp.
24	Bal. Tx Audio In	Balanced external Tx audio input (with pin 11)	600 Ohms 0dBm.
25	Bal. Rx Audio Out	Balanced un-muted Rx audio output (with pin 12)	600 Ohms 0dBm.

Note 1:- Pin 8 and Pin 20 - External GPS input is selected using a menu function or set during programming when the software option required is fitted.

Note 2:- These outputs provide channel information for use with antenna select units such as the BARRETT 916. The outputs are octal coded 0 to FF representing the least significant digit of the channel number selected. i.e. octal 0 for channel 1, octal 1 for channels 2, octal 3 for channels 2, to octal FF for channel 16.

Overview of HF operation

HF (High Frequency) is the radio spectrum with frequencies between 1.6 and 30MHz. Within this radio spectrum an efficient form of transmitter modulation, SSB (Single Side Band), is used. This, combined with the use of the ionosphere - a layer of ionisation gases that resides between 100 and 700km above the earth's surface, provides efficient, cost effective communications over short, medium and long distances - without the need for expensive re-transmission devices, such as the VHF or UHF repeaters or satellites, all of which have on going operational costs and a reliance on a physical infrastructure.

In many remote areas , HF/SSB is the only form of communication possible.

HF propagation

When HF/SSB radio waves are generated by the transceiver there are usually two components:-

- The ground-wave, which travels directly from the transmitting antenna to the receiving antenna following the contours of the earth.
- The sky-wave, which travels upward and at an angle from the antenna, until it reaches the ionosphere (an ionised layer high above the earth's surface) and is refracted back down to earth, to the receiving antenna.

Generally speaking, ground-wave is used to communicate over shorter distances usually less than 50km. Because ground-wave follows the contours of the earth, it is affected by the type of terrain it passes over. Ground wave is rapidly reduced in level when it passes over heavily forested areas or mountainous terrain.

Sky-wave is used to communicate reliably over medium to long distances up to 3,000km. Whilst the nature of sky-wave propagation means it is not affected by the type of terrain as in ground waves it is affected by factors involving the ionosphere as described below.

Radio wave propagation illustrated

The following illustrations show the characteristics of ground-wave and sky-wave propagation during day and night time. In each illustration the height of the ionosphere above the ground is shown.

In both illustrations Station A communicates with Stations B, C and D. Propagation from Station A to B is by ground-wave. The diagrams illustrate that the ground wave is not affected by the time of day and the height of the ionosphere above the ground.

Propagation from Station A to C and D, however, is by sky-wave and as the diagrams illustrate the sky wave is significantly affected by the time of day and the height of the ionosphere above the ground.

Under each diagram there are recommended working frequencies listed. Please note that these will vary according to time of year and other factors. They are intended only as a guide and are subject to change.

Day

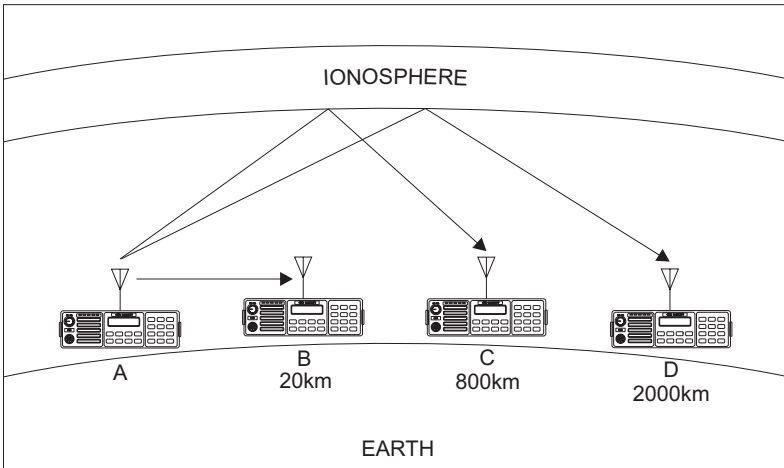

The sun is higher, the best frequency to use is higher

- A to B - Possible optimum working frequency is 3 MHz
- A to C - Possible optimum working frequency is between 7 - 9 MHz
- A to D - Possible optimum working frequency is between 13-16 MHz

Night

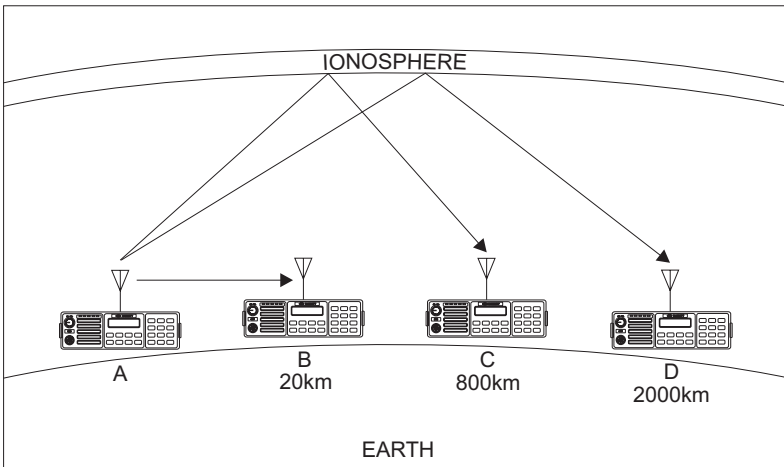

The sun is lower, best frequency to use is lower

- A to B - Possible optimum working frequency is 3 MHz
- A to C - Possible optimum working frequency is between 5 - 7 MHz
- A to D - Possible optimum working frequency is between 9 - 12 MHz

Factors which affect HF/SSB communications

There are a number of different factors which will affect the success of your communications via HF/SSB radio. These are outlined below:-

Frequency selection

Frequency selection is perhaps the most important factor that will determine the success of your HF/SSB communications.

Generally speaking the greater the distance over which you want to communicate, the higher the frequency you should use.

Beacon call, a Selcall (selective call) function built into the Barrett 950 transceiver, makes finding the correct frequency to use easy. Beacon call is based on the network transceivers all having a selection of frequencies that will accommodate most ionospheric conditions. When in standby the network transceivers scan these frequencies waiting for a call (Selcall or beacon call) from another transceiver. The transceiver wishing to check for the best frequency to operate on sends a Beacon Call to the station he wishes to contact. If his call to the other station is successful he will hear a reverte call from the station he is calling, indicating the channel he selected was suitable for the ionospheric conditions prevailing. If he does not hear this reverte call or it is very weak, he tries on another channel until a reverte call of a satisfactory signal strength is heard.

(Refer to Selcall (selective call) section of this manual for full details on Beacon call operation.)

Time of day

As a rule, the higher the sun, the higher the frequency that should be used. This means that you will generally use a low frequency to communicate early morning, late afternoon and evening, but you will use a higher frequency to cover the same distance during times when the sun is high in the sky (e.g. midday). You will need to observe the above rule carefully if your transceiver has a limited number of frequencies programmed into it, as you may only be able to communicate effectively at certain times of the day.

Weather Conditions

Certain weather conditions will also affect HF/SSB communications. Stormy conditions will increase the background noise as a result of 'static' caused by lightning. This background noise could rise to a level that will blank out the signals you are trying to receive.

Man-made electrical interference

Interference of an electrical nature can be caused by overhanging power lines, high power generators, air-conditioners, thermostats, refrigerators and vehicle engines, when in close proximity to your antenna. The result of such interference may cause a continuous or intermittent increase in the level of background noise.

System configuration and installation

The method in which your system is configured and installed will also affect the success of your HF/SSB communications. Your choice of antenna system and power supply is critical. Correct installation is also extremely important. An HF/SSB transceiver is generally installed using different rules to those used to install VHF or UHF transceivers. Failure to correctly install an HF/SSB system will greatly affect the communications quality you will obtain. Refer to the installation section of this manual for details.

Your local Barrett representative will be able to assist with your system configuration and/or installation.

Special note - HF communications compared with VHF or UHF short distance communications

Communications on any HF/SSB transceiver will sound different to that on a VHF (Very High Frequency) radio or UHF (Ultra High Frequency) radio or telephone. This is because of the nature of HF propagation and the modulation methods used. On HF/SSB transceivers there will always be background noise evident behind the signal you are receiving and this will increase when there is electrical interference or thunderstorm activity in the area.

Accessories

Accessory interface - Barrett P/N BCA90016

The BCA90016 accessory interface is provided to allow multiple interconnection to the 950 transceiver of items such as the 910 automatic tuning mobile antenna and an external GPS receiver whilst still giving access for the use of CW keys, external speakers and external alarms. The diagram below describes the pin functions of the connectors used on the accessory interface.

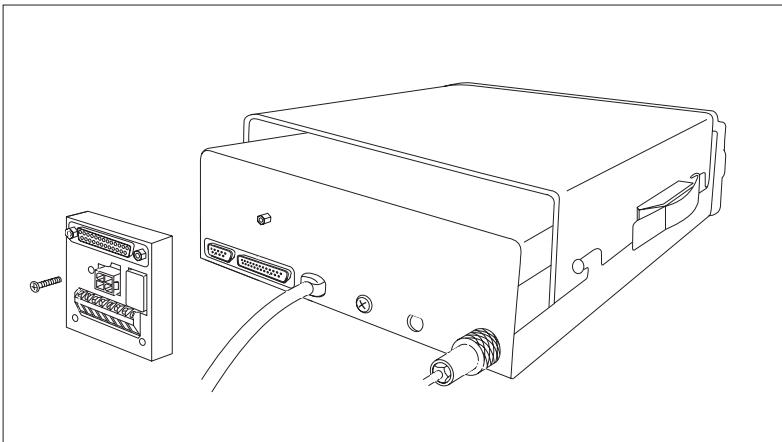
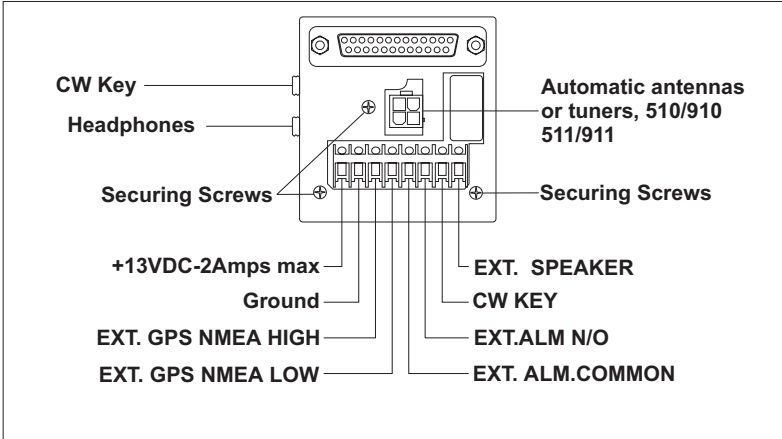

Cable assembly - Barrett P/N BCA90021

The BCA90021 cable assembly is available to interconnect the Barrett 950 transceiver and ancillary units such as the 923 modem as illustrated below:-

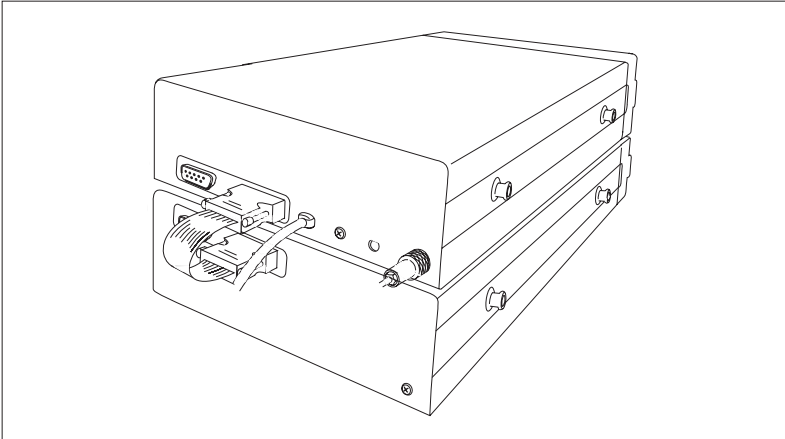

Universal mounting cradle - Barrett P/N BCA90001

The BCA90001 universal mounting cradle is available to mount Barrett 900 series products in vehicles or vessels

The cradle kit comprises the following parts:-

- 4 x M4 x 14 countersunk screws (items marked 1 in diagram)
- 4 x Nylon capstans (items marked 2 in diagram)
- 1 x Cradle assembly c/w catches

Assemble the cradle as per the diagram below:-

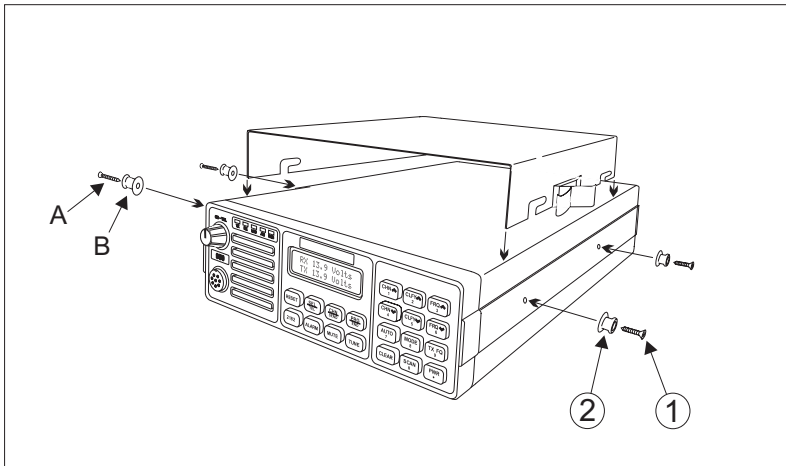

Fan unit - Barrett P/N BCA90007

The fan unit can be fitted to a transceiver at time of order or retrofitted at a later date. To retrofit the fan unit to a 950 transceiver:-

- Disconnect the power from the transceiver and remove the top and bottom cover of the transceiver.
- Insert the wires from the fan unit through the hole in the power amplifier printed circuit board. Slide the fan unit into the slots provided in the heatsink and the left hand side plate.
- Remove the screw on the PA transistor nearest to the pads used to solder the fan thermostatic switch to (TH2). Replace this screw with the fan thermostatic switch tab installed. Solder the wires from the fan thermostatic switch to the pads provided at TH2 on the PA PCB
- Solder the ends of the wires to the pads on the PA marked fan, red lead to the + and black lead to the pad marked -

Kit comprises:-

1 x fan PCB

1 x fan thermostatic switch

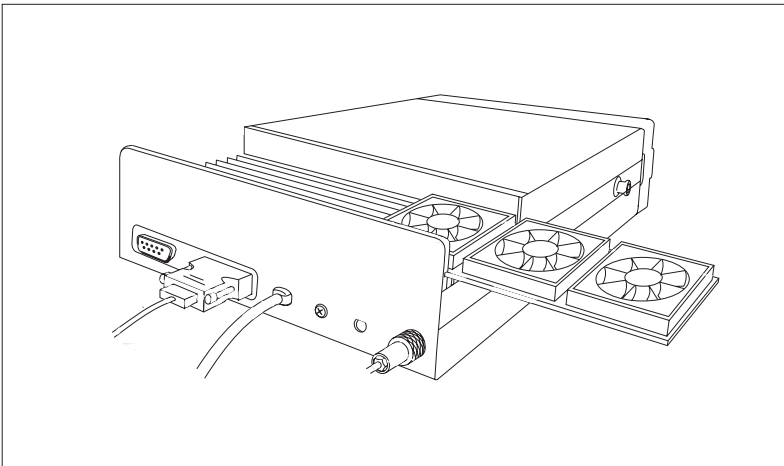

Side-plate kits - Barrett P/N BCA90025, BCA90026, BCA90027

Side-plate kits are available for stacking two, three or four 900 or 500 series units vertically. The diagram herein illustrates the method of assembly of the two unit version. Place the two units to be stacked together. Screw the side-plate onto each 900 series unit using the M4 x 6 pan head screws, with M4 nylon washers placed under each screw.

BCA90025 kit comprises:-
 8 x M4 x 6 pan head screws (Items marked 1 in diagram)
 8 x M4 nylon washers (Items marked 2 in diagram)
 2 x 2 unit side-plates (Items marked 3 in diagram)

BCA90026 kit comprises:-
 12 x M4 x 6 pan head screws (Items marked 1 in diagram)
 12 x M4 nylon washers (Items marked 2 in diagram)
 2 x 3 unit side-plates (Items marked 3 in diagram)

BCA90027 kit comprises:-
 16 x M4 x 6 pan head screws (Items marked 1 in diagram)
 16 x M4 nylon washers (Items marked 2 in diagram)
 2 x 4 unit side-plates (Items marked 3 in diagram)

BCA90025 kit shown below:-

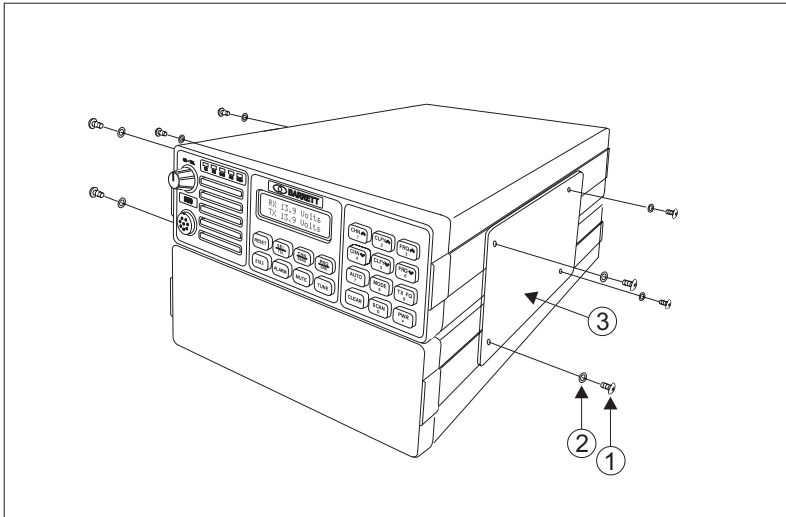

19" rack mount conversion kit - Barrett P/N BCA90010

Referring to the diagram, first attach the left and right hand side plates to the 19" front panel using the ten M4 x 6 pan head screws (items 2 on diagram), with M4 nylon washers (items 3 on diagram), placed under each screw. (make sure the Barrett logo on the front panel is orientated correctly when assembling).

Screw the "D" handles on to the front panel using the screws supplied (items 4 on diagram). When the assembly is complete mount the transceiver, power supply, modem or antenna select unit into the tray from the rear, making sure the front panel mates into the milled cut-out in the rear of the 19" front panel. Secure the transceiver in place with the remaining four M4 x 12 pan head screws (items marked 1 on diagram).

Kit comprises:-

- MW-08450 { - 1 x left hand side plate
- 1 x right hand side plate
- MW-08440 - 1 x 19" front panel
- MW-08095 - 2 x "D" handles
- NB-04597 - 10 x M4 x 6 pan head phillips screws (marked 2 on diagram)
- NB-04595 - 10 x M4 nylon washers (marked 3 on diagram)
- NB-04617 - 4 x M4 x 12 pan head pozidrive screws (marked 1 on diagram)
- NB-04598 - 4 x M6 x 16 Rack mount pan head pozidrive screws
- NB-04629 - 4 x M6 Captive nut.
- NB-00006 - 4 x M6 nylon washers
- NB-00003 - 4 x M4x 16 pan head pozidrive Screws (marked 4 on diagram)

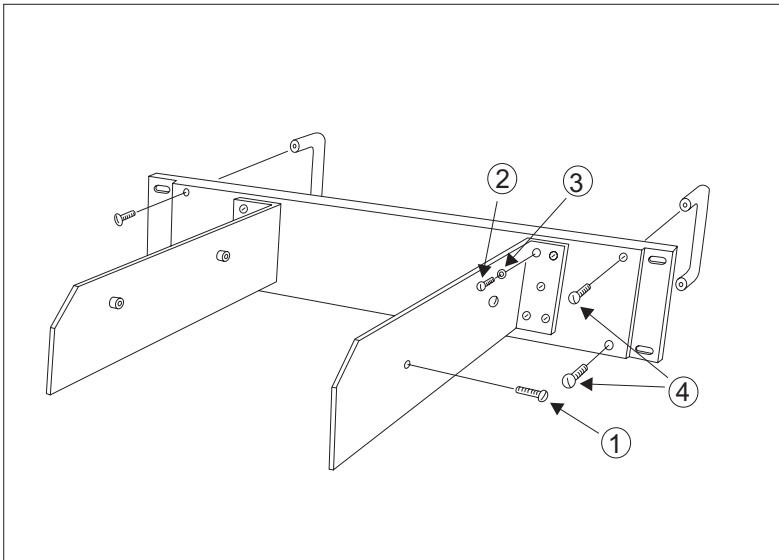

Interference suppression kit - Barrett P/N BCA90018**General**

Satisfactory suppression cannot be achieved if faults exist in the vehicle or vessel to be suppressed. Cracked distributor caps, worn commutators or burnt contacts may not yet be seriously degrading vehicle performance but will generate very high radio frequency noise levels. Before attempting to suppress noise, problems described above should be sought out and rectified.

Interference suppression kit contains:-

ITEM	QTY	DESCRIPTION	BARRETT P/N
1	1	Noise Filter MAR-60A	FI-07630
2	1	Noise Filter MAR-ACE	FI-07631
3	1	Earth Strap	PO-07633
4	1m	Earth Cable	CA-06518
5	4	8mm Terminal Lugs	CN-07640
6	4	10mm Terminal Lugs	CN-07641
7	4	Capacitors	CP-01515
8	1	Suppressor	NB-04563
9	1	Clamp	NB-04565

Ignition systems

Audible as a 'popping' noise - frequency varies with engine speed.

High tension

High tension wiring should be of the impregnated neoprene type. Suppression cables using graphite powder in a paper core are not reliable. If necessary replace with a suitable set of suppression cables recommended for the vehicle. All high tension wiring should be separated from any other wiring and should be placed as close to the metal block of the motor as practical to reduce radiation of any RF noise.

Low tension

Ensure that the wire from the distributor points to the ignition coil is as short as possible and that it is not loomed together with any other cables. If the wire length exceeds 300mm it should be replaced by a screened wire. This may be coaxial cable with the shield connected to ground or simply consist of a twisted pair of wires, one used for the distribution/coil connection and the other earthed at **both** ends. Keep all wiring as short as possible.

In some cases the wiring from battery to coil may require suppression. In this case use the MAR-60A noise filter supplied in this kit.

Battery charging systems

Alternator or generator

Audible as a whine - frequency dependant on engine speed.

Fit an MAR-60A noise filter as supplied in this kit in series with the main charging output of the alternator. If a satisfactory earth point cannot be found on or immediately adjacent to the alternator then the alternator/filter connection should be screened.

Generators are treated in the same way as alternators.

Charge regulator

Audible as a 'sizzling' noise above engine idle speed. The alternator/regulator control ('field') wire should be removed from any other wiring by replacing with screened wire. Capacitors should not be connected between this wire and ground as they may damage the regulator.

Instrumentation

Some vehicles use thermal chopping regulators and/or sensors within their instrument systems. These may be heard as a noise similar to the charge regulator which starts 5 to 20 seconds after the engine is started. This can be suppressed using capacitors on the supply side and screening on the switched side of the device.

Accessories

Windscreen wipers, fans, and all other electrical accessories should be checked to ensure they do not contribute RF noise. They can be suppressed using MAR-ACE filters or capacitors and the installation method given in the MAR-ACE application note.

Bonding

All metal objects on a vehicle or vessel should be bonded to one common earth with reliable connections. Ensure that the body of a vehicle is connected to chassis by-passing any rubber mounts that may be present. Heavy duty earth straps are supplied for this purpose.

Additional information for suppression of Toyota Land Cruiser's with vibrating reed oil pressure sensors

Many Toyota Land Cruiser's have a vibrating reed oil pressure sensor. This unit generates square waves which cause severe interference over the entire HF band. The oil pressure sensor is usually located on the right hand side of the motor at the rear and down low looking from the front of the vehicle. It is a circular device coloured dull yellow with a single electrical connection on the end. To suppress this unit a 0.47uF single ended suppressor should be used. (Supplied in this kit). Usually there are no bolts available in the area to attach the earth side of the suppressor. If this is the case a 50mm hose clamp (also supplied in this kit) should be fitted around the oil sensor body. The earth lugs on the 0.47uF suppressor should be fitted under the clamp and the clamp tightened. The flying lead of the suppressor should then be connected to the electrical terminal on oil sensor.

For more information regarding suppression refer to the Mobile installation section.

Note:- Specifications, information and drawings in this manual are subject to change without notice.