



9390 Reference manual

No part of this handbook may be reproduced,
transcribed, translated into any language or transmitted
in any form whatsoever without the prior written
consent of Codan Pty Ltd.

© Copyright 1996 Codan Pty Ltd.

Codan part number 15-04069 Issue 1, May 1996

Contents



1 About this manual

Standards and icons	1-3
Glossary	1-4
Other documents	1-6

2 Installation

Type of station	2-2
Coast station	2-2
Ship station	2-3
Installing the transceiver	2-5
Mounting the cradle, gimbals and transceiver	2-5
Installing the control head	2-7
Mounting the cradle and control head	2-7
Connecting the control head	2-8
Power supply	2-10
Mains operated supply	2-10
Battery supply	2-10
DC power cable	2-10
Grounding—RF earth	2-12
Ship stations	2-12
Coast stations	2-14
9390 transceiver and control head grounding	2-15
Ancillary equipment	2-16
Antennas and antenna tuners	2-16

3 Channel and scan table setup

Customising channels	3-2
Channel settings	3-2
Changing channel settings	3-3
Copying a channel to a new channel number	3-4
Changing a channel comment	3-6
Changing channel options	3-8
Changing the receive frequency of a channel	3-11
Creating a receive-only channel	3-13
Creating a receive-only channel in Free-Tune Receiver mode	3-16
Deleting a channel	3-19
Creating a transmit channel (option)	3-21
Creating a scan table	3-24
Deleting a scan table	3-29
Creating a telephone directory (option)	3-31

4 Using Setup mode

Using Setup mode	4-2
List of Setup mode procedures	4-3
Advanced users	4-7

5 Setup procedures (part 1)

ALE option settings (option)	5-2
Changing an ALE option setting	5-7
ALE option reset (option)	5-9
ALE sounding interval (option)	5-11
Beep loudness	5-13
Call preamble length (option)	5-15
Call privacy on/off (option)	5-17
Clock calibration	5-19
Clock setting	5-21
Clone a transceiver	5-26

6 Setup procedures (part 2)

Display brightness.....	6-2
Display contrast	6-4
Display frequency	6-6
Free-Tune Receiver mode availability on/off	6-9
GPS display on/off (option)	6-11
GPS timeout on/off (option)	6-13

7 Setup procedures (part 3)

Password entry to enable transceiver options	7-2
Enabling transceiver options	7-2
Deleting a PIN.....	7-6
Power up message on/off.....	7-8
Power up mute setting.....	7-11
Power up selcall self ID display on/off (option)	7-14
PTT release beep on/off.....	7-16
PTT transmit cutout	7-18
Recall channels by frequency on/off.....	7-20
RF gain on/off.....	7-22
RS-232 connected equipment	7-24
RS-232 connection baud rate.....	7-27

8 Setup procedures (part 4)

Scan table automatic scanning start	8-2
Scan table editing on/off	8-4
Selcall ID setup (option).....	8-6
Setting up a selcall group	8-7
Selcall ID size compatibility (option)	8-13
Selcall lockout on/off (option).....	8-16
Selcall mute availability on/off (option)	8-19
Telcall availability on/off (option).....	8-21
Tone call setup.....	8-23
99-beacon call response on/off (option)	8-26

9 Link Setup mode

Link Setup mode enter/exit.....	9-2
Antenna band or channel control	9-5
PIN setup	9-7
Setup mode availability on/off.....	9-10
Transceiver reset to factory settings	9-12

10 Display messages

11 Appendix

Connectors.....	11-2
Microphone socket.....	11-3
Antenna Control connector	11-4
Remote Control connector	11-5
GP connector.....	11-6
RS-232 socket	11-7
Loudspeaker socket.....	11-7
External alarm socket.....	11-7
Connecting ancillary equipment	11-8
Using the optional RS-232/I ² C Interface	11-10
Setting up the RS-232/I ² C Interface.....	11-11
Specifications.....	11-14
Transceiver options.....	11-15
Accessories	11-16

Index

Figures

Figure 2.1	A typical coast station installation	2-2
Figure 2.2	A typical ship station installation	2-3
Figure 2.3	High power ship station installation (24 volt)	2-4
Figure 2.4	Rear view of control head without cover plate ...	2-8
Figure 2.5	General grounding requirements for metal hulled vessels.....	2-12
Figure 2.6	General grounding requirements for wooden or fibreglass hulled vessels	2-13
Figure 2.7	General grounding requirements for 9390-H receive-exciter—all hull types	2-14
Figure 4.1	The Setup mode tree.....	4-8
Figure 9.1	Moving the link for Link Setup mode	9-2



1 About this manual

This manual describes how you set up the Codan 9390 HF SSB transceiver or the Codan 9390-H receiver-exciter.

This issue of the manual incorporates operating information for software versions:

- transceiver 3.02
- control head 3.01.

To check the version of your transceiver, refer to the *User guide, Chapter 4, Using View All Settings mode—transceiver software issue*.

You should refer to this manual when you want to:

- set up the transceiver for the first time
- change how the transceiver operates
- use options or ancillary equipment with the transceiver.

The manual contains 11 chapters.

Chapter 1 explains how to use the manual.

Chapter 2 explains how to install your transceiver and connect the components that make up your station.

Chapter 3 explains how to set up channels, scan tables and the telephone directory.

Chapter 4 explains how to use Setup mode to set up how the transceiver works. You should read this before following any Setup mode procedure described in Chapters 5–8.

Chapters 5–8 describe the Setup mode procedures which have been separated into four parts for ease of reference.

Chapter 9 describes Link Setup mode procedures.

Chapter 10 lists all information and error messages output to the transceiver display.

Chapter 11 covers technical information such as the connector pin arrangements, ancillary equipment settings, transceiver specifications, options and accessories.

We recommend that only Codan approved service agents perform maintenance on the transceiver.

Standards and icons

In this manual, Arial typeface in single quotes is used for text shown on the transceiver display. For example:

If 'no response' was displayed, send the call again.

Arial typeface in bold is used for the names of buttons, knobs and connectors. For example:

Press the **On/Off** button.

This icon...



Means...

the end of a subject.



a warning.

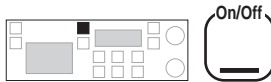

the transceiver button or knob that you need to operate (the **On/Off** button in this example). The solid area in the picture of the transceiver control panel on the left shows you where to find the button or knob.



the microphone button that you need to operate (the **Call** button in this example). The solid area in the picture of the microphone on the left shows you where to find the button.

Glossary

This term...	Means...
ALE	Automatic Link Establishment.
AM	Amplitude Modulation.
Call memory	a list containing details of the last ten calls you have received.
Called ID	the ID of the station being called (the receiving station's self ID).
EPROM	Erasable Programmable Read-Only Memory.
GPS	Global Positioning System.
HF	High Frequency.
LCD	Liquid Crystal Display.
LSB	Lower Sideband.
LU	Lower/Upper Sideband.
PCB	Printed Circuit Board.
PIN	Personal Identification Number.
PSTN	Public Switched Telephone Network.
PTT button	Press-To-Talk button.
RDD	Radio Direct Dial.
Receive-only channel	a channel that allows you to receive calls but not send calls.
Receiver-exciter	a version of the transceiver designed to operate with an external high power RF amplifier (400 watts PEP).
Revertive signal	an acknowledgment signal automatically transmitted from a station receiving a call.
RF	Radio Frequency.
Rx	Receive.

This term...	Means...
Scan table	a list of channels used when scanning for incoming calls.
Selcall	the simplest type of selective call.
Selective calling	a call to a specific station (transceiver option). Selective calls include beacon calls, selcalls, telcalls, GPS calls, page calls and ALE calls.
Self ID	the programmed address identification number of your station. (Used by other stations to call you.)
SSB	Single Sideband transmission format.
Transceiver-exciter	a version of the transceiver designed to operate with an external high power RF amplifier (400 watts PEP).
Transceiver ID	a unique, factory programmed 16-character alpha-numeric identification code.
Transmit channel	a channel that allows you to receive and transmit calls.
Two-frequency simplex	a channel that has different transmit and receive frequencies but does not allow simultaneous send and receive.
Tx	Transmit.
TXE	Transmit Enabled. To enable user programming of transmit frequency.
USB	Upper Sideband.

Other documents

For information on how you use the transceiver to send and receive calls, refer to the *9390 User guide* (Codan part number 15-04068).

For information on ALE calling, refer to the *9300 ALE controller user guide* (Codan part number 15-04046).



2 Installation



This chapter describes how to install your transceiver and connect the components that make up your station.

It covers:

- type of station (2-2)
- installing the transceiver (2-5)
- installing the control head (2-7)
- power supply (2-10)
- grounding—RF earth (2-12)
- ancillary equipment (2-16).

On receipt of your transceiver, check the contents against the packing list. Ensure all items are available before starting installation.

The procedures for installing your transceiver are not comprehensive. They are to be used as a guide only. We recommend that installation be carried out by qualified and experienced personnel.

Type of station

You can operate the transceiver from more than one place if you attach control heads to your system. Control heads have the same control panel as the transceiver. The smaller depth of the control head allows you to mount the unit where there is insufficient space for the transceiver.

There are two types of station:

- coast station
- ship station.

Coast station

A fixed base coast station typically consists of an AC power supply connected directly to the mains. DC output from the power supply is connected to the transceiver which, in turn, is connected to an antenna system.

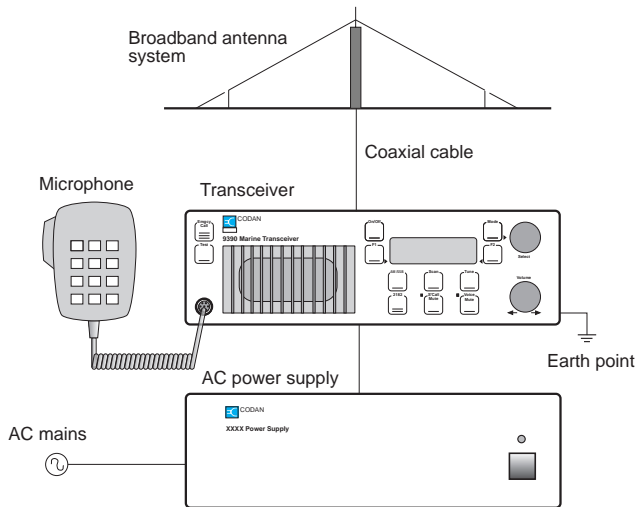

Figure 2.1 A typical coast station installation

Ship station

A ship station typically consists of a DC power supply (battery) connected to the transceiver. A coaxial cable connects the transceiver to an antenna tuning unit which is attached to a whip or long wire antenna.

The transceiver and microphone should be mounted in such a way as to be easily accessible to the operator.

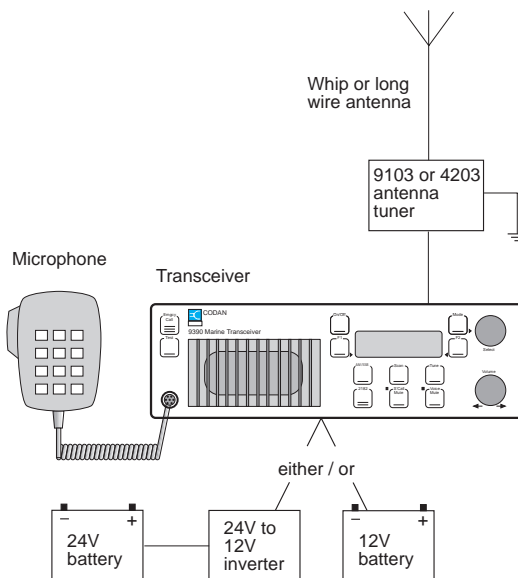

Figure 2.2 A typical ship station installation

For 400 watt high power systems using a 9390-H receiver-exciter, an external PA unit is connected between the receiver-exciter and the antenna tuning unit.

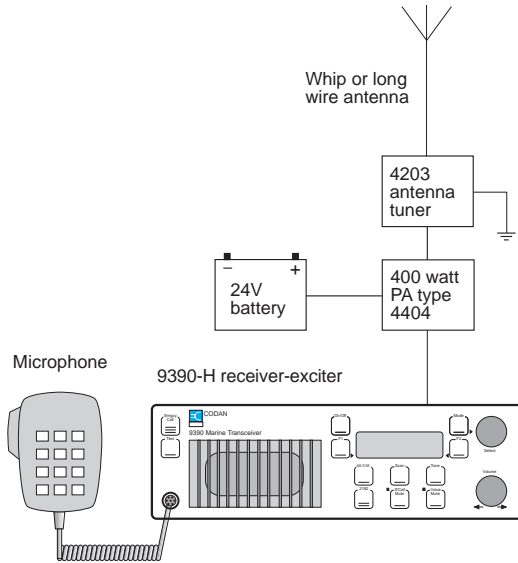

Figure 2.3 High power ship station installation (24 volt)

Where cables must pass through bulkheads with sharp edges, the insulation of the cables should be protected by grommets. Holes in the bulkhead need only be large enough to allow the end of the cable with the smaller connector to pass through (for example, the control cable between the control head and the transceiver).



If the power and control cables are long and follow a common path, keep the cables separated by at least 200mm. The cables can be closer together for short distances, for example, to pass through the same hole in the bulkhead.

Failure to observe this warning can cause distortion of the transmitted audio signals.



Installing the transceiver



The transceiver must be mounted in a position that:

- *allows easy access to the controls*
- *allows a free flow of air through the rear cooling fins*
- *is not exposed to direct sunlight*
- *will not cause injury in the event of rough conditions or an accident.*

Mounting the cradle, gimbals and transceiver

The cradle and gimbals for mounting the transceiver are suitable for locations where there is enough space available to slide the transceiver in and out.

The cradle provides DC isolation for the transceiver.

To mount the cradle, gimbals and transceiver:

1. Assemble the supplied pair of mounting gimbals onto the cradle in the position and angle that provides good access to the mounted transceiver controls. Two fixing bolts (M5 x 8mm) for each gimbal are supplied.
2. Secure the cradle in position with the rotating cam catches to the front. Ensure there is sufficient space at the rear of the cradle to clear the transceiver heat sink and connectors.
3. Align both cam catch slots with the T-section slides.

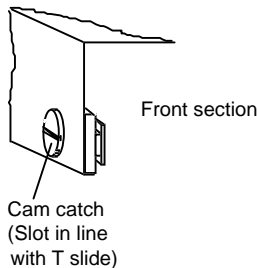

4. Insert the transceiver side rails into the T-section slides and push the transceiver fully into the cradle.
5. Apply gentle pressure to the front of the transceiver and lock it into the cradle by using a flat blade screwdriver to turn the cam catches one quarter of a turn in either direction.



Installing the control head



*Make sure that the transceiver is disconnected from the DC power source before connecting the control head to the **Remote Control** connector on the transceiver.*

Mounting the cradle and control head

To mount the cradle and control head:

1. Select a suitable location to mount the control head. Avoid places exposed to direct sunlight.
2. Remove the two cradle screws and washers securing the cradle to the control head.
3. Secure the cradle into position. Ensure that there is sufficient space at the rear for the cables.
4. Secure the control head to the cradle with the two screws and washers.

Connecting the control head

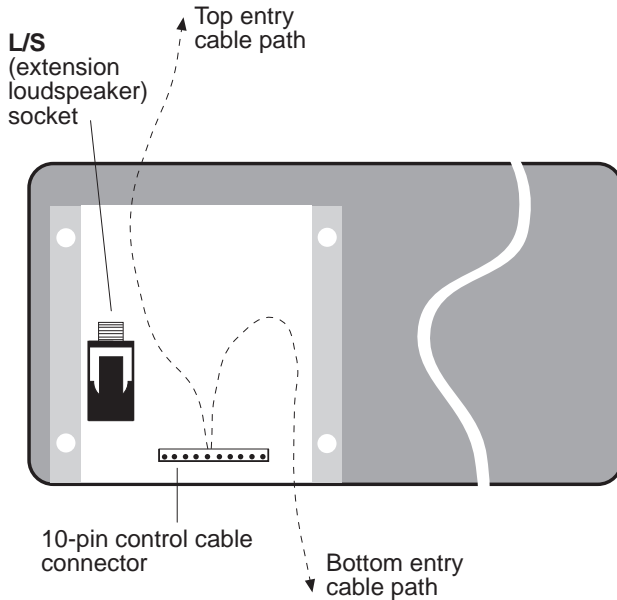

Figure 2.4 Rear view of control head without cover plate

The control head chassis is isolated from ground but in operation may require earthing. See *Grounding—RF earth* on page 2-12.

To connect the control head:

1. Remove the four screws that secure the small cover plate at the back of the control head. Remove the cover. Figure 2.4 shows the back of the control head with the cover plate removed.
2. If you are connecting an extension loudspeaker, feed the loudspeaker cable through the foam grommet near the control head end of the control cable. Note that the transceiver also has provision for connecting the extension loudspeaker.
3. Use the cable clamp to attach the control cable to the inside surface of the cover.

4. Plug the control cable into the 10-pin connector (the cable only fits one way).
5. If you are connecting an extension loudspeaker, plug the loudspeaker cable into the **L/S** (extension loudspeaker) socket.
6. Insert the foam grommet into the slot on the cover plate.
7. The cover plate can be rotated to give you either top or bottom cable entry. Replace the cover plate and secure it with the four screws.
8. Make sure that the transceiver is disconnected from the DC power source.
9. Plug the control cable into the **Remote Control** connector on the rear panel of the transceiver. Fasten the cable securely.
10. Plug in the microphone by gently rotating the plug in the microphone socket until the pins locate. Push the plug home and fasten the locking ring until finger-tight. Do not over tighten.
11. If the 6-metre control cable is too long, gather the excess neatly and secure it out of the way. Do not cut the cable.



*Make sure that the transceiver is disconnected from the DC power source before connecting the control head to the **Remote Control** connector on the transceiver.*



Power supply

Ensure that the power supply and power cable for the transceiver is suitable for correct and safe system operation.

For both 12V and 24V DC systems the power source can be mains operated or battery.

Mains operated supply

We recommend the Codan AC power supply 9113 or 9114 for 12V DC operated 9390 front or extended control transceivers. The 9114 is necessary if you are going to use your transceiver for fax or data transmissions.

We recommend the heavy duty AC power supply accessory code 507 for 24V DC operated systems using the 9390-H receiver-exciter and the PA type 4404.

Battery supply

You can use standard, heavy duty 12V or 24V batteries as the system supply. If a 12V system has to be powered from a 24V battery, install the accessory code 508 voltage regulator (12V) within two metres of the transceiver.

DC power cable

It is important that the size of the DC power cable (cross sectional area) is sufficient to keep the voltage drop between power source and transceiver within close limits.

To check the effectiveness of the power cable installation with the tuner and antenna connected, press the **Tune** button and measure the voltage at the transceiver end of the cable. The voltage should not drop more than 0.5V compared with the voltage on receive only.

9390 front and extended control 12V systems are supplied with 6-metre power cables. 9390-H receiver-exciter 24V 400 watt systems are supplied with 2-metre power cables. If a supplied cable is too short, a larger cable size must be used replacing the existing cable. Refer to the following table.

Maximum distance from power source	12V system cable size	24V 400 watt system cable size
6 metres	Use supplied cable	16mm ² (7/1.7mm)
9 metres	16mm ² (7/1.7mm)	25mm ² (19/1.35mm)
18 metres	25mm ² (19/1.35mm)	50mm ² (19/1.78mm)

Protect all cables from sharp edges and mechanical abrasion.

We recommend that you fit a suitable cartridge fuse in the active wire close to the battery or main isolating switch. This protects the power cable and your vessel from risk of fire should damaged insulation cause a short circuit. Use a 32A fuse for a 12V system (accessory code 711) or a 50A fuse for a 24V, 400 watt system. Do not use normal glass in-line automotive fuses as these cause too high a voltage drop during transmission.

A qualified technician should check your installation before power is applied to the transceiver.



In extended control installations where the power and control cables are long and follow a common path, keep the cables separated by at least 200mm. The cables can be closer together for short distances, for example, to pass through the same hole in the bulkhead.

Failure to observe this warning can cause distortion of the transmitted audio signals.



Grounding—RF earth

A good ground (RF earth) is essential for efficient operation of the installed transceiver system.

This section is a general guide for achieving the best performance from your installation. For maximum reliability and safety, we recommend that you also seek expert advice specific to your installation.



Inappropriate earthing can result in severe damage to your vessel through electrolytic corrosion.

The chassis and earth point of the 9390 transceiver are connected to the negative supply. The 9390-H receiver-exciter, control head, PA type 4404, code 733B Aerial DC Isolator and antenna tuners have isolated earth points.

Ship stations

A metal hulled vessel in salt water provides an almost ideal ground. Connect the tuner and any other equipment requiring an earth to the hull using the shortest possible ground strap. To minimise contact resistance, use a large, clean and paint-free contact area.

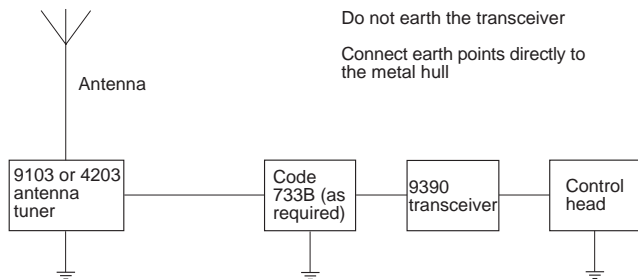

Figure 2.5 General grounding requirements for metal hulled vessels

Wooden or fibreglass hulled vessels present more of a grounding problem. Use bonding straps to connect the antenna tuner and all other earth points directly to a radio earth plate attached to the outside of the hull below the water line.

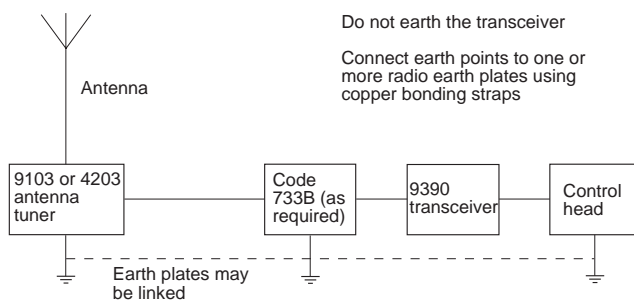

Figure 2.6 General grounding requirements for wooden or fibreglass hulled vessels

The earth plate may be a 1mm thick copper sheet of at least 0.25 square metres or an E-plate, such as accessory code 157. Multiple earth plates may be an advantage.

Bonding should be with 25–50mm wide copper straps for lengths up to two metres. Use proportionately wider or multiple straps for longer runs. A thickness of 0.5mm is sufficient since the RF current only flows on the conductor surface. Alternatively, you can use 20mm diameter copper tubing.

Run one or more bonding straps from the earth plate to the antenna tuner. Where possible, joints should be brazed and inspected regularly for corrosion.

The general grounding requirements for 9390-H receiver-exciter systems are the same for all hull types.

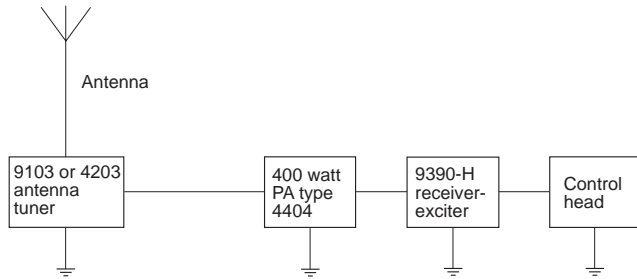

Figure 2.7 General grounding requirements for 9390-H receive-exciter—all hull types

Coast stations

For typical coast station installations (see Figure 2.1 on page 2-2) we recommend that you earth the chassis ground point of the transceiver.

You can establish an effective ground with an earthing spike or water pipe that has good soil contact and is free of joints that could increase the path resistance to earth. Use copper braid of at least 12mm wide for the connection.

9390 transceiver and control head grounding

Grounding the 9390 transceiver or control head is unnecessary for most installations. If RF interference causes transmit distortion, you may need to ground either or both units.

The transceiver chassis is connected to battery negative and will be DC isolated from ground when installed with the cradle (see *Installing the transceiver* on page 2-5).

If the transceiver needs to be grounded, use a code 733B Aerial DC Isolator to isolate the transceiver when connecting to the antenna tuner and the RF earth point.

To earth the control head, earth the mounting bracket by ensuring that the screws holding the mounting bracket are not insulated. It may be necessary to remove paint from around the screws to ensure a good contact.



Ancillary equipment

There is a range of ancillary equipment you can connect to the transceiver. For details, see *Chapter 11, Connecting ancillary equipment*.

Antennas and antenna tuners

Correct installation of the antenna and antenna tuner is important for good transceiver operation.

To obtain the best performance and good radiation efficiency from your transceiver, consider the antenna and antenna tuner's:

- physical location
- distance from the transceiver
- grounding.

Follow the installation instructions provided with each antenna and antenna tuner to achieve the best possible performance.



3 Channel and scan table setup

This chapter covers:

- customising channels (3-2)
- copying a channel to a new channel number (3-4)
- changing a channel comment (3-6)
- changing channel options (3-8)
- changing the receive frequency of a channel (3-11)
- creating a receive-only channel (3-13)
- creating a receive-only channel in Free-Tune Receiver mode (3-16)
- deleting a channel (3-19)
- creating a transmit channel (option, 3-21)
- creating a scan table (3-24)
- deleting a scan table (3-29)
- creating a telephone directory (option, 3-31).

Customising channels

You can customise the way channels are set up in your transceiver. For example, you might want to:

- change channel comments to help you remember how channels are used
- copy regularly used channels to group them for convenience (for example, creating a group of 10 channels with channel numbers 9001 to 9010).

Channel settings

Transmit channel settings consist of:

- frequency (either a single transmit/receive frequency or a two-frequency simplex)
- sideband (upper and AM—lower/selectable needs local authority approval)
- tone call group (1–4 or none)
- selcall group (option, 1–5 or none)
- channel protection (on/off)
- channel comment (description of channel).

Receive-only channel settings consist of:

- frequency
- sideband (upper/lower/selectable)
- channel protection (on/off)
- channel comment (description of channel).

When you send a call, the frequency and sideband have to be the same for both stations. The channel number is unimportant.

Changing channel settings

Factory fitted, standard marine channels consist of:

- protected channels
- Radphone channels.

If you want to change the settings of a protected channel, make an unprotected copy of the channel and edit the copy. You may then change any channel setting except for the transmit frequency.

If your transceiver has option TXE, you can change the setting of a protected channel including the transmit frequency.





You can change Radphone channel options and comments but not frequencies (even with TXE). To reset a Radphone channel to its factory set condition, you delete the modified version. You cannot delete factory set Radphone channels.

If you change the single transmit/receive frequency of a transmit channel, the channel becomes a two-frequency simplex with a new receive frequency. The transmit frequency remains unchanged.



Copying a channel to a new channel number

To copy a channel to a new channel number:

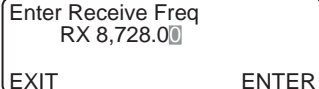



Action	Notes
<p>1. In Channel mode, select the channel that you want to copy.</p>	<p>Example of the display for channel 804:</p> 
<p>2. Press twice</p> 	<p>Example of the display:</p> 
<p>3. Enter the number of a new, unused channel</p> 	<p>For example, enter 9991 to copy channel 804 to channel 9991.</p>
<p>4. Press</p> 	<p>Example of the display:</p> 



Action	Notes												
<p>5. To save the new channel, press four times</p> <div style="display: flex; align-items: center; justify-content: center; gap: 20px;">  <div style="border: 1px solid black; padding: 5px; text-align: center;"> <p>Enter</p> <p>R'call</p> </div> </div>	<p>The display shows the new channel:</p> <div style="border: 1px solid black; padding: 5px; margin-top: 10px;"> <table style="width: 100%; border-collapse: collapse;"> <tr> <td colspan="3" style="text-align: left; padding: 2px;">Radphone</td> </tr> <tr> <td style="font-size: small; padding: 2px;">USB</td> <td style="font-size: 2em; font-weight: bold; padding: 2px;">9991</td> <td style="font-size: small; padding: 2px;">8,204</td> </tr> <tr> <td style="font-size: small; padding: 2px;">HI</td> <td style="font-size: 2em; font-weight: bold; padding: 2px;">▶ 8,728</td> <td style="font-size: small; padding: 2px;">Pwr</td> </tr> <tr> <td style="font-size: small; padding: 2px;">RF-ON</td> <td style="font-size: small; padding: 2px;">Rx.</td> <td style="font-size: small; padding: 2px;"></td> </tr> </table> </div>	Radphone			USB	9991	8,204	HI	▶ 8,728	Pwr	RF-ON	Rx.	
Radphone													
USB	9991	8,204											
HI	▶ 8,728	Pwr											
RF-ON	Rx.												

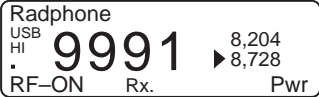

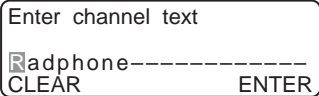
Changing a channel comment

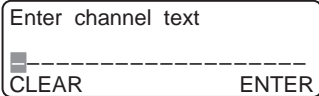
To change a channel comment:

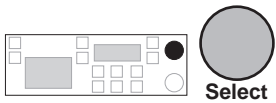
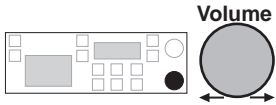
Action	Notes
<p>1. In Channel mode, select the channel that you want to change.</p>	<p>Example of the display for channel 9991:</p> 
<p>2. Repeatedly press   until you see 'Enter channel text' displayed.</p>	<p>Example of the display:</p> 
<p>3. To clear any existing text, press  </p>	<p>Example of the display:</p> 

Action	Notes
<p>4. To enter a comment to describe this channel, rotate</p>	<p>Enter up to 20 characters (for example, Trawler Network).</p>
 <p>to select each character and</p>	
 <p>to move along the line to the next character position.</p>	
<p>5. To save your changes for the channel, press</p>	<p>Example of the display:</p>
	



Changing channel options

You cannot change the channel options of protected channels (unless you have option TXE). If you want to change these settings, make an unprotected copy of the channel and edit the copy.

The table below lists which of the four channel options you can change for each type of unprotected channel.

	Transmit channel	Receive-only channel	Radphone channel
Sideband	Yes *	Yes	No
Tone call group	Yes	No	Yes
Selcall group	Yes	No	Yes
Channel protection	Yes	Yes	No







* You need local authority approval to change the sideband setting from USB.



Use caution when changing the channel protection option!

Once you protect a channel, only a Codan agent can change or delete this channel without deleting many other channels from the transceiver (unless you have option TXE).

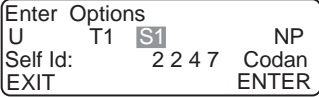
To change channel options:

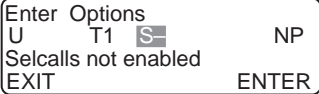
- | Action | Notes |
|--|--|
| <p>1. In Channel mode, select the channel that you want to change.</p> | <p>Example of the display for channel 9991:</p>  <p>The screenshot shows a radio display for channel 9991. It includes the text 'Trawler Network', 'USB HI', 'RF-ON', 'Rx.', '8,204', '8,728', and 'Pwr'.</p> |
| <p>2. Repeatedly press  Enter R'call until you see 'Enter Options' displayed.</p> | <p>Example of the display:</p>  <p>The screenshot shows the 'Enter Options' menu with 'U' selected under 'Options'. Other options include 'T1 S1', 'Upper sideband', and 'EXIT'. 'NP' and 'ENTER' are also visible.</p> |
| <p>3. To move to the option setting you want to change, rotate .</p> | <p>Example of the selcall group setting:</p>  <p>The screenshot shows the 'Enter Options' menu with 'S1' selected under 'Options'. Other options include 'U', 'T1', 'Self Id: 2 2 4 7', 'EXIT', 'Codan', and 'ENTER'. 'NP' is also visible.</p> |
| <p>4. To change the setting, rotate .</p> | <p>Selcalling is now disabled for this channel:</p>  <p>The screenshot shows the 'Enter Options' menu with 'S' selected under 'Options'. Other options include 'U', 'T1', 'Selcalls not enabled', 'EXIT', and 'ENTER'. 'NP' is also visible.</p> |

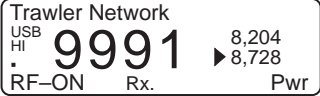





Action	Notes
<p>5. Do you want to change another option setting?</p> <p>Yes ➤ Return to Step 3.</p> <p>No ➤ Step 6.</p>	
<p>6. To save your changes for the channel, press twice</p>	<p>Example of the display:</p>  



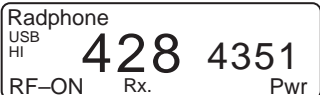







Changing the receive frequency of a channel

Frequencies of protected channels (unless you have option TXE) and Radphone channels cannot be changed. To change the receive frequency of one of these channels, you copy the channel and edit the copy.

To change the receive frequency of a protected or Radphone channel:

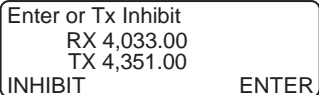

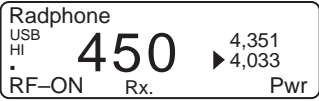





Action	Notes
<p>1. In Channel mode, select the channel that you want to change.</p>	<p>Example of the display for channel 428:</p> 
<p>2. Press twice</p>  	<p>Example of the display:</p> 
<p>3. Enter the number of a new, unused channel</p>  	<p>For example, enter 450 to copy channel 428 to unused channel 450.</p>







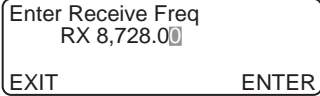

Action	Notes
<p>4. Press</p>  	<p>Example of the display:</p> 
<p>5. Enter the new receive frequency</p>  	<p>Enter the kHz frequency to two decimal places. For example, to enter 4033kHz, enter 403300.</p> <p>Changing the receive frequency makes this channel a two-frequency simplex.</p>
<p>6. Press</p>  	<p>Example of the display:</p> 
<p>7. To save the new channel, press three times</p>  	<p>Example of the display:</p> 



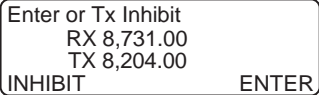
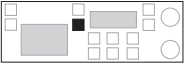

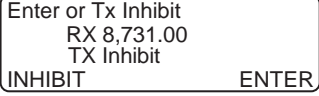
Creating a receive-only channel

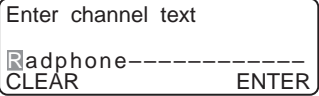
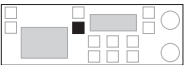
To create a receive-only channel:

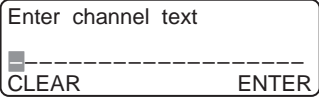
Action	Notes
<p>1. In Channel mode, press twice</p>  	<p>Example of the display:</p> 
<p>2. Enter the number of a new, unused channel</p>  	<p>For example, enter 9991.</p> <p>If you do not enter a number, you will edit the displayed channel instead of creating a new one.</p>
<p>3. Press</p>  	<p>Example of the display:</p> 
<p>4. Enter the receive frequency</p>  	<p>Enter the kHz frequency to two decimal places. For example, to enter 8731kHz, enter 873100.</p>

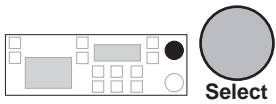
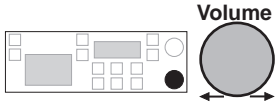
Action	Notes
<p>5. Press</p>  	<p>Example of the display:</p> 
<p>6. Press</p>  	<p>Example of the display:</p> 
<p>7. Press twice</p>  	<p>Example of the display:</p> 
<p>8. To clear any existing channel comment, press</p>  	<p>Example of the display:</p> 

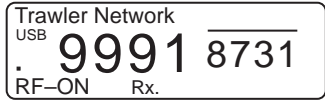
Action	Notes
<p>9. To enter a comment to describe this channel, rotate</p>	<p>Enter up to 20 characters (for example, Trawler Network).</p>
 <p>to select each character and</p>	
 <p>to move along the line to the next character position.</p>	
<p>10. To save the new channel, press</p>	<p>The bar displayed above the frequency indicates that this channel is receive-only:</p>
	





Creating a receive-only channel in Free-Tune Receiver mode





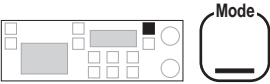
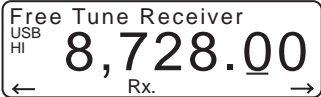





This method of creating receive-only channels allows you to listen to broadcasts on different frequencies before deciding what frequencies to store as channels for ease of future listening.

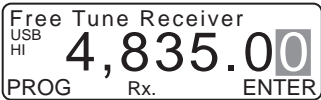

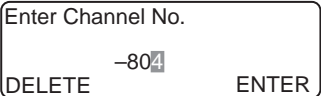
Due to internally generated signals, it is difficult to receive on and near frequencies 7303, 9125, 10950, 12775, 14607, 18250, 20075, 21900 and 23725kHz.

To create a receive-only channel in Free-Tune Receiver mode:

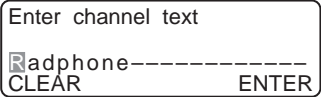
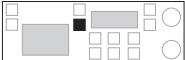
Action	Notes
<p>1. Repeatedly press</p>  <p>until you see 'Free-Tune Receiver' displayed.</p>	<p>Example of the display:</p> 
<p>2. Make any changes to the frequency.</p>	<p>Example of the display for Radio Australia's frequency of 4835kHz:</p> 

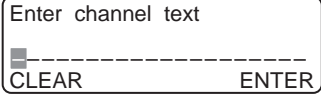
To change the frequency, refer to the *9390 User guide, Chapter 4, Using Free-Tune Receiver mode.*

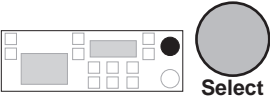
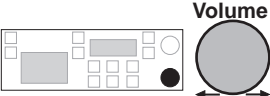
Action	Notes
<p>3. Press</p>  	<p>Example of the display:</p> 
<p>4. Press</p>  	<p>Example of the display:</p> 
<p>5. Enter the number of a new, unused channel</p>  	<p>For example, enter 9808.</p> <p>If you do not enter a number, you will edit the displayed channel instead of creating a new one.</p>
<p>6. Press twice</p>  	<p>Example of the display:</p> 
<p>7. To clear any existing channel comment, press</p>  	<p>Example of the display:</p> 

Action	Notes
<p data-bbox="185 220 557 306">8. To enter a comment to describe this channel, rotate</p>  <p data-bbox="288 459 539 513">to select each character and</p>  <p data-bbox="288 663 557 746">to move along the line to the next character position.</p>	<p data-bbox="636 220 954 274">Enter up to 20 characters (for example, Radio Australia).</p>
<p data-bbox="185 826 557 912">9. To return to Channel mode saving the new channel, press</p> 	<p data-bbox="636 826 954 912">The bar displayed above the frequency indicates that this channel is receive-only:</p> 







Deleting a channel

This procedure deletes unprotected channels.

You cannot delete protected channels unless you have option TXE.

You cannot delete factory set Radphone channels. Deleting a modified Radphone channel resets the Radphone channel to its factory set condition.

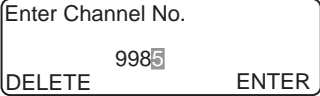
To delete a channel:

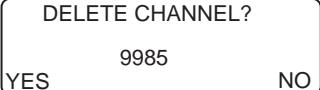
Action	Notes
<p>1. In Channel mode, select the channel that you want to delete.</p>	<p>Example of the display for channel 9985:</p> 
<p>Unprotected channels show the unprotected marker (small square) on the left of the display.</p>	<p>Unprotected channels show the unprotected marker (small square) on the left of the display.</p>
<p>2. Press twice</p>  	<p>Example of the display:</p> 
<p>3. Press</p>  	<p>Example of the display:</p> 

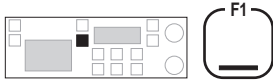
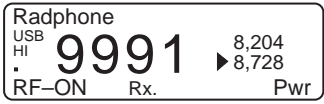
Action	Notes
<p data-bbox="181 220 347 248">4. Press</p> 	<p data-bbox="636 220 984 343">The transceiver deletes the channel, 'beeps' and displays the channel with the next larger channel number:</p>  <pre data-bbox="636 359 960 462">Radphone USB HI 9991 8,204 RF-ON Rx. 8,728 Pwr</pre>











Creating a transmit channel (option)



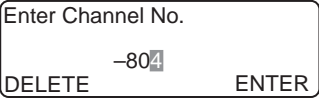







You can only use this procedure to create a transmit channel if you have option TXE (Transmit Enable).

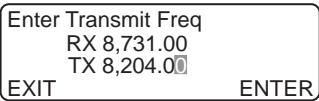

TXE allows you to change the transmit frequency of any channel except a Radphone channel. TXE overrides any channel protection.

Under special circumstances TXE may be fitted at the time of purchase where local licensing authorities permit.

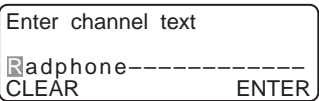
To create a transmit channel:

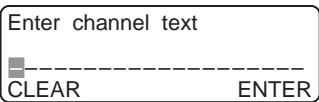
Action	Notes
<p>1. In Channel mode, press twice</p>  	<p>Example of the display:</p> 
<p>2. Enter the number of a new, unused channel</p>  	<p>For example, enter 9991.</p> <p>If you do not enter a number, you will edit the displayed channel instead of creating a new one.</p>
<p>3. Press</p>  	<p>Example of the display:</p> 

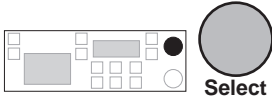
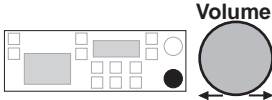
Action	Notes
<p>4. Enter the receive frequency</p>  	<p>Enter the kHz frequency to two decimal places. For example, to enter 8731kHz, enter 873100.</p>
<p>5. Press</p>  	<p>Example of the display:</p> 
<p>6. Enter the transmit frequency</p>  	<p>Enter the kHz frequency to two decimal places. For example, to enter 8550kHz, enter 855000.</p> <p>Entering 0 inhibits transmission and makes this channel receive-only.</p>
<p>7. Press twice</p>  	<p>Example of the display:</p> 
<p>8. To clear any existing channel comment, press</p>  	<p>Example of the display:</p> 

Action	Notes
<p>9. To enter a comment to describe this channel, rotate</p>	<p>Enter up to 20 characters (for example, Trawler Network).</p>
 <p>The diagram shows a control panel with various buttons. A large circular button on the right is shaded and labeled "Select".</p>	
<p>to select each character and</p>	
 <p>The diagram shows the same control panel. A large circular knob on the right is shaded and labeled "Volume". A horizontal double-headed arrow is positioned below the knob.</p>	
<p>to move along the line to the next character position.</p>	
<p>10. To save the new channel, press</p>	<p>Example of the display:</p>
 <p>The diagram shows a handheld device with a keypad and a button labeled "Enter R'call".</p>	 <p>The screenshot shows a radio display with the following text: "Trawler Network", "USB HI", "9991", "8,550", "8,731", "RF-ON Rx.", and "Pwr".</p>



Creating a scan table

This procedure sets up any of the three scan tables.

You can only make changes to scan tables if scan table editing is switched on (see *Chapter 8, Scan table editing on/off*).

Each scan table can hold up to ten channels. You can add a channel to the scan table more than once if you want the channel to be scanned several times in each scan cycle.

You can select one of several scan types as displayed:

‘Selcall’ Selcall scanning is the normal setting if you have enabled the selcall option and you expect to receive selcalls. Mute is on so that no voice transmissions are heard. (Use of selcall mute needs to be on. See *Chapter 8, Selcall mute availability on/off*.)

Each channel is scanned for 0.6 seconds.
Scanning only stops for selcalls.

‘Cont’ Use Continuous scanning if you want to listen to voice traffic as the channels are scanned.

Each channel is scanned for 0.6 seconds.
Scanning only stops for selcalls. Mute is off.

‘Pause’ Use Pause scanning if you expect voice calls and want scanning to pause for five seconds when voice is detected on the channel.

Each channel is scanned for one second unless voice is detected. Scanning also stops for selcalls.

‘Hold’ Use Hold scanning if you expect voice calls and want scanning to hold for as long as the voice is detected on the channel.

Each channel is scanned for one second unless voice is detected. Scanning also stops for selcalls.



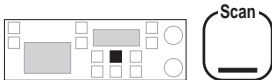
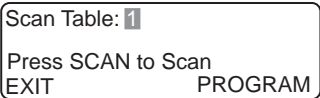
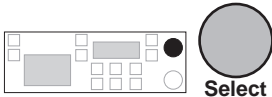
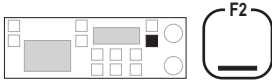
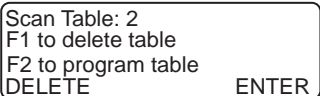

‘ALE’ (option) Use ALE scanning if you are using an ALE controller and expect ALE calls.

Scanning stops for both selcall and ALE calls. Mute is on.

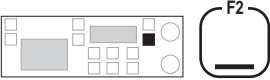
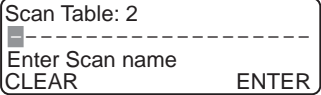
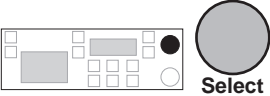
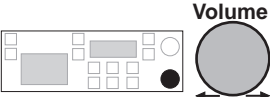
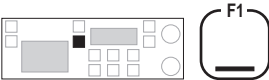
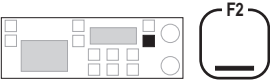
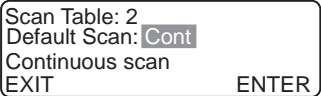
To set up a scan table:

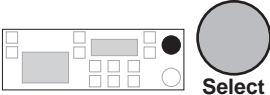
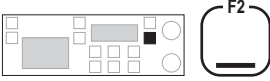
Action	Notes
<p>1. In Channel mode, press</p> 	<p>The display shows:</p> 
<p>2. To select one of the three scan tables, rotate</p> 	<p>Select scan table 1, 2 or 3.</p>
<p>3. Press</p> 	<p>Example of the display for scan table 2:</p> 

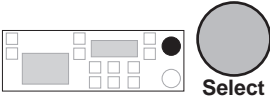
Action	Notes
<p>4. Press</p> 	<p>Example of the display:</p> 
<p>5. To enter a comment to describe this scan table, rotate</p>  <p>to select each character and</p>  <p>to move along the line to the next character position.</p>	<p>Enter up to 20 characters (for example, Ship to shore).</p> <p>To clear any existing text, press</p> 
<p>6. Press</p> 	<p>Example of the display:</p> 

Action	Notes
<p>7. To switch between the types of scanning, rotate</p> 	<p>Select:</p> <ul style="list-style-type: none"> • ‘Selcall’ for normal selcall scanning (option) • ‘Cont’ for scanning without muting channel traffic • ‘Pause’ for voice call scanning to pause five seconds on voice detection • ‘Hold’ for voice call scanning to hold on voice detection • ‘ALE’ for ALE call scanning (option).
<p>8. Press</p> 	<p>Example of the display:</p> 
<p>9. To select the channel to add to the scan table, rotate</p> 	<p>You can add up to ten channels to the scan table.</p> <p>To delete a channel already added to the scan table (showing ‘Prog’ at the top right of the display), press</p> 

Action

Notes

- 10.** To add the displayed channel to the scan table, press

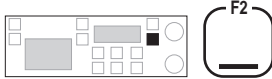

'Prog x1' indicates that this channel is now entered once in the scan table:

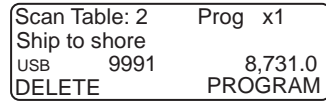

- 11.** Do you want to add another channel to the scan table?

Yes ➤ **Return to Step 9.**
 No ➤ **Step 12.**

- 12.** To save your changes, press

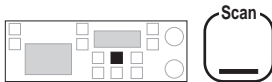

Example of the display:



Return to **Step 2** if you want to set up another scan table.





Deleting a scan table

This procedure deletes any of the three scan tables.

You can only delete scan tables if scan table editing is switched on (see *Chapter 8, Scan table editing on/off*).

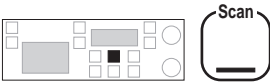
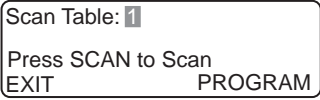
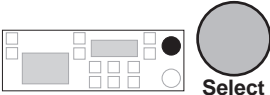
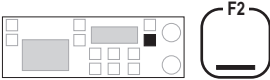
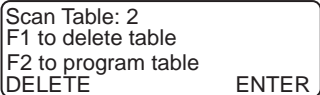
To delete a scan table:

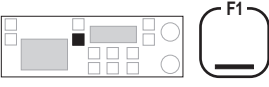
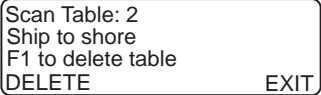
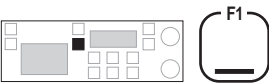
Action	Notes
<p>1. In Channel mode, press</p> 	<p>The display shows:</p> 
<p>2. To select one of the three scan tables for deletion, rotate</p> 	<p>Select scan table 1, 2 or 3.</p>
<p>3. Press</p> 	<p>Example of the display for scan table 2:</p> 

Action	Notes
<p data-bbox="181 220 348 248">4. Press</p> 	<p data-bbox="639 220 891 248">Example of the display:</p> 
<p data-bbox="181 440 549 501">5. To delete the scan table, press</p> 	<p data-bbox="639 440 891 469">Example of the display:</p> 



Creating a telephone directory (option)

This procedure sets up the telephone directory for making telcalls.









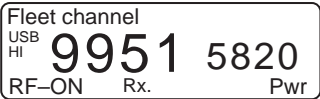

Before you can use the telephone directory, you need to enable the selcall option (see Chapter 7, Password entry to enable transceiver options).

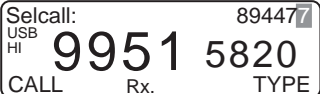
The telephone directory operates like a telephone book. It can hold ten telephone entries (numbered 0–9). Each entry consists of a telephone number and a comment.

You can only access the telephone directory from channels that allow selcalling by being attached to a selcall group. To check the selcall group setting for a channel, refer to the *9390 User guide, Chapter 4, Using View Channel Options mode*.

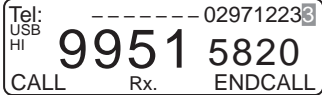
To add or clear entries from the telephone directory:

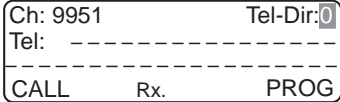
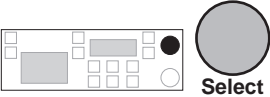
Action	Notes
<p>1. In Channel mode, select a channel that is set up for selcalling.</p>	<p>Example of the display for channel 9951:</p> 
<p>2. Press</p>  	<p>Example of the display:</p> 

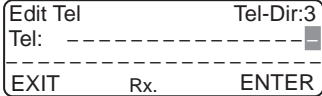
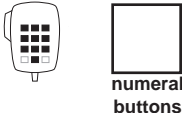
Action	Notes
<p>3. Press</p> 	<p>Example of the display:</p> 
<p>4. Press</p> 	<p>Example of the display:</p> 
<p>5. To select one of the ten entries, rotate</p> 	<p>Select entry 0–9.</p>
<p>6. Press</p> 	<p>Example of the display for entry 3:</p> 
<p>7. Enter the telephone number</p> 	<p>To cancel an existing number and leave this entry unused, enter 0.</p>

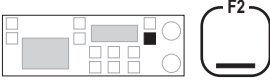
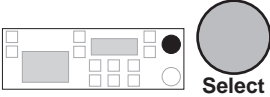
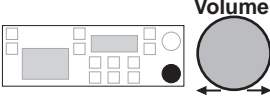
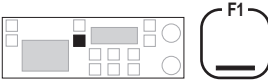
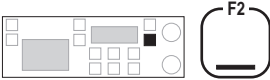
- | Action | Notes | | | | | | | | |
|--|---|-----------|-----------|------------|-----------|----------------|-----------|------|----------|
| <p>8. Press</p>  | <p>Example of the display for number 083050311:</p> <table border="1" data-bbox="692 300 1012 395"> <tr> <td>Edit Text</td> <td>Tel-Dir:3</td> </tr> <tr> <td>Tel: -----</td> <td>083050311</td> </tr> <tr> <td>CLEAR</td> <td>Rx. ENTER</td> </tr> </table> | Edit Text | Tel-Dir:3 | Tel: ----- | 083050311 | CLEAR | Rx. ENTER | | |
| Edit Text | Tel-Dir:3 | | | | | | | | |
| Tel: ----- | 083050311 | | | | | | | | |
| CLEAR | Rx. ENTER | | | | | | | | |
| <p>9. To enter a comment, rotate</p>  <p>to select each character and</p>  <p>to move along the line to the next character position.</p> | <p>Enter up to 20 characters to describe the number (for example, person's name and location).</p> <p>To clear any existing text, press</p>  | | | | | | | | |
| <p>10. To save your changes, press</p>  | <p>Example of the display:</p> <table border="1" data-bbox="692 1062 1012 1158"> <tr> <td>Ch: 9951</td> <td>Tel-Dir:3</td> </tr> <tr> <td>Tel: -----</td> <td>083050311</td> </tr> <tr> <td>Codan Adelaide</td> <td></td> </tr> <tr> <td>CALL</td> <td>Rx. PROG</td> </tr> </table> | Ch: 9951 | Tel-Dir:3 | Tel: ----- | 083050311 | Codan Adelaide | | CALL | Rx. PROG |
| Ch: 9951 | Tel-Dir:3 | | | | | | | | |
| Tel: ----- | 083050311 | | | | | | | | |
| Codan Adelaide | | | | | | | | | |
| CALL | Rx. PROG | | | | | | | | |
| <p>11. Do you want to add another telephone number?</p> <p>Yes > Return to Step 5.</p> <p>No > Step 12.</p> | | | | | | | | | |

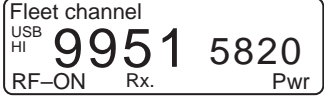
Action	Notes
<p>12. To return to Channel mode, press</p>  PTT	<p>Example of the display:</p> 



4 Using Setup mode

Setup mode allows you to view and change settings that control transceiver operation.

This chapter:

- explains how to use Setup mode (4-2)
- lists the procedures available in Setup mode (4-3)
- gives some tips on using Setup mode for advanced users (4-7).

You should read this chapter before running any of the Setup mode procedures. Chapters 5–8 cover Setup mode procedures in detail.

Using Setup mode

You enter Setup mode by pressing the **Mode** button on the control panel four times starting with the Channel mode setting.

The easiest way to use Setup mode is to find which procedure you want from the following list and turn to the description of the procedure for further details and step by step guidance. Procedures are listed in Chapters 5–8.

You start each transceiver procedure by entering a setup code.

Procedures labelled optional are only available if you contact Codan for a password to enable them in your transceiver (see *Chapter 7, Password entry to enable transceiver options*).

If you make a mistake in setting a value and want to avoid saving your changes, press the **F1** button on the control panel or **PTT** button on the microphone to return to an earlier step in the procedure. Repeated pressing of either button progresses you back to Channel mode.

If you do not touch any button or knob for 60 seconds while in Setup mode, the transceiver automatically reverts to Channel mode. If this happens while you are in the middle of a procedure, start the procedure again.

The descriptions for the procedures show examples of channel and frequency numbers. You must enter your own values.



List of Setup mode procedures

Procedure	Page	Setup code	Description
ALE option settings	5-2	2431	Controls how the ALE controller works (option).
ALE option reset	5-9	2432	Resets the ALE option settings 0–16 to their factory values (option).
ALE sounding interval	5-11	2433	Changes the ALE sounding time interval (option).
Beep loudness	5-13	33	Controls the volume of ‘beep’ tones made by the transceiver.
Call preamble length	5-15	242	Sets the length of the preamble transmitted at the start of a selcall or ALE call (option).
Call privacy on/off	5-17	2443	Limits the stations that can receive your transmissions of GPS and page information (option).
Clock calibration	5-19	412	Calibrates the transceiver clock against an external standard.
Clock setting	5-21	411	Sets the time and date of the transceiver clock.
Clone a transceiver	5-26		Copies the settings from one transceiver to another by a process called cloning.
Display brightness	6-2	311	Controls the brightness of the display.
Display contrast	6-4	312	Controls the contrast of the display.

Procedure	Page	Setup code	Description
Display frequency	6-6	313	Controls the displayed channel frequency.
Free-Tune Receiver mode availability on/off	6-9	3442	Controls the use of Free-Tune Receiver mode.
GPS display on/off	6-11	3421	Switches on or off the display of your transceiver's GPS latitude and longitude (option).
GPS timeout on/off	6-13	3422	Switches GPS timeout warning on or off (option).
Password entry to enable transceiver options	7-2	42	Enables transceiver options that are built into the transceiver and deletes forgotten PINs.
Power up message on/off	7-8	34411	Allows you to set up a message which is displayed for several seconds when the transceiver is powered up.
Power up mute setting	7-11	34412	Controls the initial mute setting used when the transceiver is powered up.
Power up selcall self ID display on/off	7-14	34413	Controls whether the self ID is displayed when the transceiver is powered up (option).
PTT release beep on/off	7-16	3432	Switches PTT release 'beeping' on or off.
PTT transmit cut-out	7-18	3431	Prevents the transceiver from being left on in the transmit state by mistake.
Recall channels by frequency on/off	7-20	32	Controls whether you can recall channels by frequency as well as channel number.

Procedure	Page	Setup code	Description
RF gain on/off	7-22	3443	Controls the RF gain to change the receive sensitivity.
RS-232 connected equipment	7-24	3411	Controls what equipment is connected to the transceiver rear panel.
RS-232 connection baud rate	7-27	3412	Sets the speed of information transfer for equipment connected to the transceiver rear panel.
Scan table automatic scanning start	8-2	11	Sets the time delay for starting automatic scanning.
Scan table editing on/off	8-4	12	Switches scan table editing on or off.
Selcall ID setup	8-6	211	Sets up IDs for any of the transceiver's five selcall groups S1–S5 (option).
Selcall ID size compatibility	8-13	213	Controls how you communicate with stations that are incapable of using IDs longer than four digits (option).
Selcall lockout on/off	8-16	2441	Switches selcall lockout on or off (option).
Selcall mute availability on/off	8-19	212	Controls whether you can select selcall mute from the control panel (option).
Telcall availability on/off	8-21	22	Controls whether your transceiver can send telcalls (option).

Procedure	Page	Setup code	Description
Tone call setup	8-23	23	Sets up the high and low frequency pairs for any of the four tone call groups T1–T4.
99-Beacon call response on/off	8-26	241	Controls whether the transceiver can respond to received 99-beacon calls (option).



Advanced users

This section explains how Setup mode procedures are arranged in the transceiver. You do not need to understand this to use Setup mode, but some readers may find this knowledge useful.

The Setup mode tree in Figure 4.1 shows how Setup mode procedures are accessed. Each menu of options displayed by the transceiver is represented by a branch in this tree.

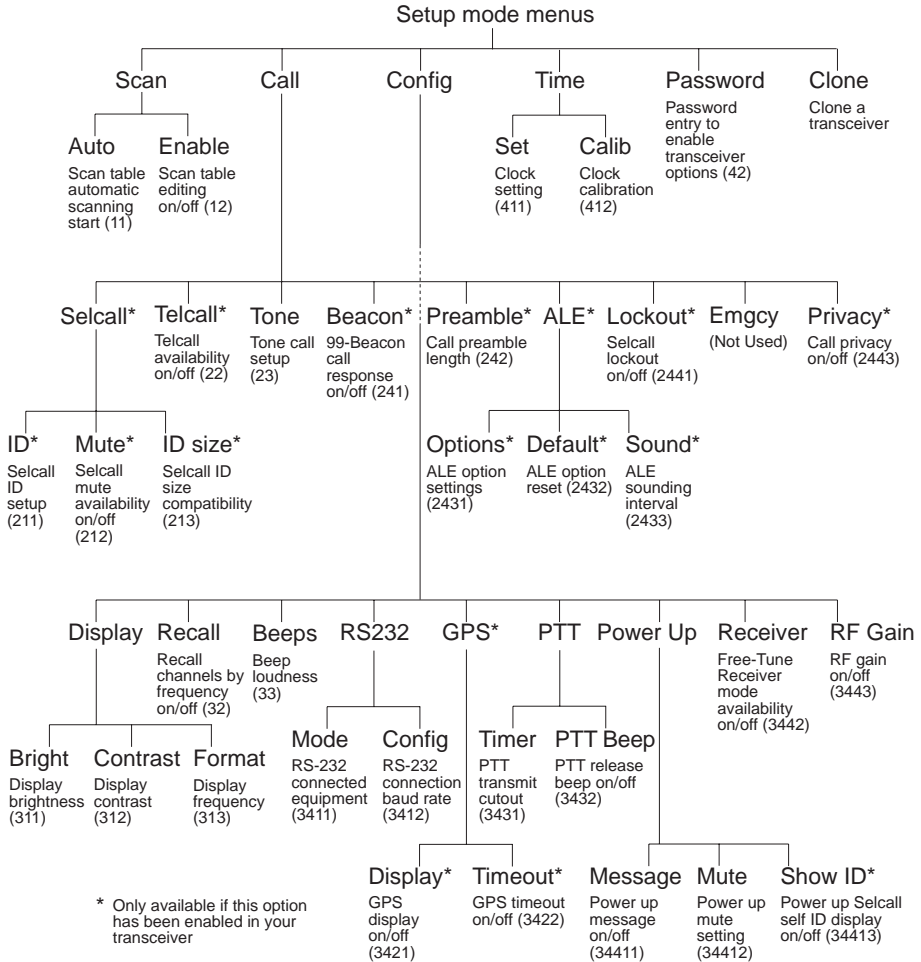

Figure 4.1 The Setup mode tree

If you are comfortable using menus and selecting menu options, you can refer to the Setup mode tree instead of entering setup codes to access each procedure. This allows you to use Setup mode by directly following the guidance shown on the transceiver display.

Each branch in the menu tree shows:

- the name of the menu item shown on the display
- the name in small print of the equivalent procedure in this manual, if any, for this menu item
- the setup code in parentheses.

To navigate around the Setup mode tree, use front panel button:

- **F2** to select a highlighted menu option and advance down the tree
- **F1** to go back up the tree to the previous menu.

For example, you could branch down to the 'Power Up' menu and view each of the 'Power Up' menu options, 'Message', 'Mute' and 'Show ID', in turn making any changes to settings as necessary.



Using Setup mode procedures

5 Setup procedures (part 1)

This chapter describes the following Setup mode procedures:

- ALE option settings (option, 5-2)
- ALE option reset (option, 5-9)
- ALE sounding interval (option, 5-11)
- Beep loudness (5-13)
- Call preamble length (option, 5-15)
- Call privacy on/off (option, 5-17)
- Clock calibration (5-19)
- Clock setting (5-21)
- Clone a transceiver (5-26).

ALE option settings (option)

Setup code 2431

This procedure controls how the ALE (Automatic Link Establishment) controller works.



Before you can use this procedure, you need to enable both the selcall and ALE options (see Chapter 7, Password entry to enable transceiver options).

There are 17 ALE system settings numbered 0–16. These settings control ALE call performance and do not usually require changing. You can change nine. The remaining eight are not displayed since their values are fixed.

Setting No.	Description
0	Sounding On/Off
2	Channel Quality Decay Time
3	Sounding Signal Length
5	BER Threshold
6	Golay Threshold
7	Error Threshold
11	ALE Silent Mode
13	Call Retry Limit
14	Channel Quality Averaging

For further information, this manual should be read in conjunction with the *9300 ALE controller user guide* (Codan part number 15-04046).

Sounding On/Off (ALE option 0)

This ALE option switches sounding on or off.

When sounding is switched off, your transceiver no longer sends or receives ALE sounding signals. For correct ALE operation, you should leave sounding on all the time.

If ALE Silent Mode (ALE option 11) is switched on, the Sounding On/Off option setting is ignored and your station does not send or receive ALE sounding signals. To set the sounding interval, see *ALE sounding interval* on page 5-11.

Channel Quality Decay Time (ALE option 2)

This ALE option sets the artificial decay time for the record of channel quality that is stored in the channel quality table in ALE controller memory.

You can switch decay off or set a decay time in the range 1–8 hours.

For example, switching the sounding off and setting a decay time of four hours would result in the record of a perfect channel (100% channel quality) decaying to an unusable channel (0% channel quality) over a period of four hours.

Sounding Signal Length (ALE option 3)

This ALE option sets the length in seconds of the sounding transmission for each channel in the scan group.

When an ALE station sends sounding signals, a separate signal is transmitted for each channel in the scan group. The ALE station sends these signals sequentially. The total length of the sounding transmission is the product of the sounding signal length and the number of channels.

For example, if the sounding signal length is set to 10 seconds and the scan group contains seven channels, the ALE station takes 70 seconds to complete sounding transmission.

The default sounding signal length is the minimum setting (under five seconds). The maximum setting is 100 seconds.

Bit Error Rate (BER) Threshold (ALE option 5)

This ALE option sets the value of the BER Threshold used in BER testing.

You can set a value in the range 0–48.

BER testing is a method of error detection for ALE word transmission. ALE stations send and receive ALE link controlling information in blocks of data called ALE words. An ALE word consists of a 3-bit preamble and a 21-bit data field.

The result of BER error testing is used in helping to decide whether the ALE link can be established using the current channel.

The higher the BER value of a transmitted ALE word, the greater the error. A BER value of 0 indicates perfect reception of an ALE word. The maximum BER value of 48 indicates that all bits of the ALE word were bad.

If a received ALE word contains more errors than the BER Threshold, the ALE controller rejects the word. The lower you set the BER Threshold, the tougher the test for rejecting transmission errors.

Golay Threshold (ALE option 6)

This ALE option sets the value of the Golay Threshold used in Golay testing.

You can set a value in the range 0–4.

Golay testing is an additional method of error detection for ALE word transmission. The result of Golay error testing is used in helping to decide whether the ALE link can be established using the selected channel.

The higher the Golay value calculated for a received ALE word, the greater the error.

If a received ALE word contains more errors than the Golay Threshold, the ALE controller rejects the word. The lower you set the Golay Threshold, the tougher the test for rejecting transmission errors.

Error Threshold (ALE option 7)

This ALE option sets the maximum number of sequentially received bad ALE words which are allowed before the ALE controller decides that the quality of the current channel is too poor to establish an ALE link. A bad word is a word that has exceeded either the BER or Golay Threshold.

You can set a value in the range 0–4.

If the test fails during the process of establishing the ALE link, the call aborts and the transceiver returns to Scan mode.

ALE Silent Mode (ALE option 11)

This ALE option switches ALE Silent mode on or off.

When ALE Silent mode is switched off, the station runs as a normal ALE station.

When ALE Silent mode is switched on, the station no longer:

- recognises any incoming ALE calls
- sends or receives sounding signals even if Sounding On/Off (ALE option 0) is switched on.

You can still send ALE calls in ALE Silent mode.

Call Retry Limit (ALE option 13)

This ALE option controls the number of times the ALE station tries to establish an ALE link using each channel in turn from the scan group.

You can set 99 for no limit or a value in the range 0–98.

On each selected channel, two attempts are made to establish a link before trying the next preferred channel, where two more attempts are made and so on, until all channels in the scan table have been tried (unless a link is established).

The sequence is then repeated dependent upon the number set in the Call Retry Limit.

If a link is not established, the display shows 'LINK FAILED' accompanied by error 'beeps'. Retry duration can be up to one minute per channel.

Channel Quality Averaging (ALE option 14)

This ALE option sets the method used to update an existing channel quality value stored in ALE controller memory when the new channel quality reading is worse than the stored value.



You can:

- replace old values with new readings
- replace old values with different weighted averages of the old values and new readings.

Averaging reduces the effect that one bad reading might otherwise have on a perfect channel. If a new reading is better than an old value, the old value is replaced by the reading.

Changing an ALE option setting

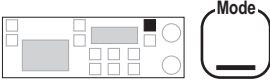
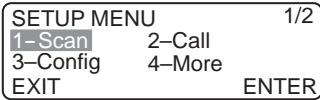
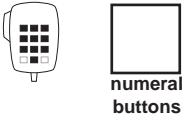
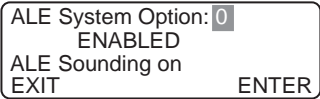
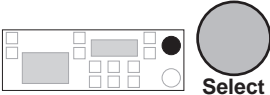
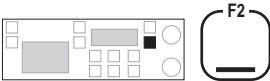
To change an ALE option setting:

Action	Notes
<p>1. Repeatedly press</p>  <p>until you see the display for Setup mode.</p>	<p>The display shows:</p> 
<p>2. Enter 2431</p> 	<p>Example of the display:</p> 
<p>3. To find the ALE option you want to change, rotate</p> 	<p>The name of the option setting is shown on the third line of each display.</p> <p>You can only display and change nine of the 17 ALE options (numbered 0–16).</p>
<p>4. To select this ALE option, press</p> 	<p>For example, option 13 (Call Retry Limit) looks like this:</p> 

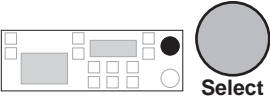
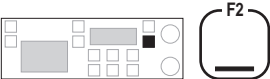
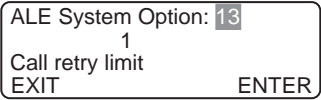
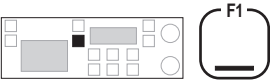
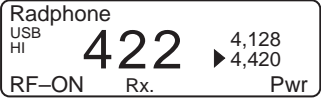
Action	Notes
<p>5. To change the setting, rotate</p> 	
<p>6. To save your change, press</p> 	<p>Example of the display:</p> 
<p>7. Do you want to change another ALE option?</p> <p>Yes ➤ Return to Step 3.</p> <p>No ➤ Step 8.</p>	
<p>8. To return to Channel mode, press four times</p> 	<p>Example of the display:</p> 



ALE option reset (option)



Setup code 2432

This procedure resets 9 of the 17 ALE (Automatic Link Establishment) option settings 0–16 to their factory values.

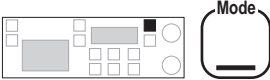

Before you can use this procedure, you need to enable both the selcall and ALE options (see Chapter 7, Password entry to enable transceiver options).

To reset the ALE option settings:

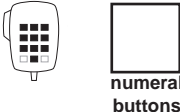
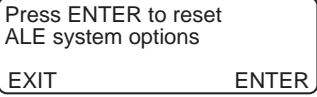
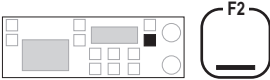
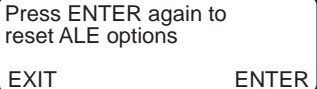
Action	Notes
<p>1. Repeatedly press</p>  <p>until you see the display for Setup mode.</p>	<p>The display shows:</p> 
<p>2. Enter 2432</p> 	<p>The display shows:</p> 
<p>3. Press</p> 	<p>The display shows:</p> 

Action

Notes

4. To confirm resetting, press

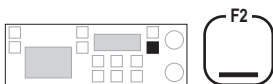

The transceiver ‘beeps’ after resetting all ALE options.

The display shows:

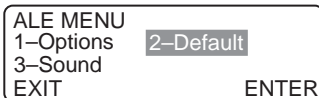

5. To return to Channel mode, press three times



Example of the display:

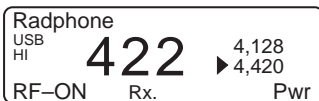

ALE sounding interval (option)

Setup code 2433

This procedure changes the ALE (Automatic Link Establishment) sounding time interval.



Before you can use this procedure, you need to enable both the selcall and ALE options (see Chapter 7, Password entry to enable transceiver options).





ALE stations repeatedly send sounding signals to determine how good each channel is for transmission. The ALE sounding interval is the time between signal transmissions.

You can select:

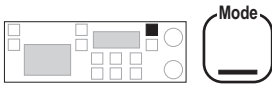
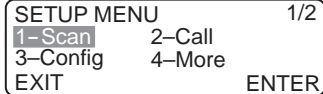
- ‘30 Mins’
- ‘45 Mins’
- ‘1 Hour’
- ‘2 Hours’
- ‘4 Hours’
- ‘8 Hours’
- ‘16 Hours’.

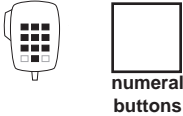
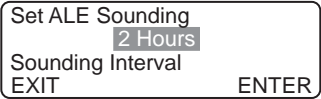
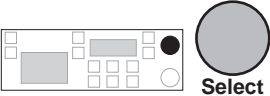
To change the ALE sounding time interval:

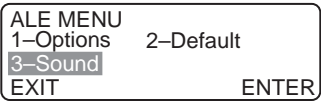
Action	Notes
1. Repeatedly press	The display shows:
	
until you see the display for Setup mode.	

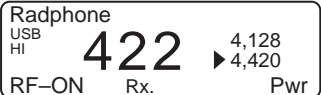
Action	Notes
<p>2. Enter 2433</p> 	<p>Example of the display:</p> 
<p>3. To change the ALE sounding interval, rotate</p> 	<p>Select a time in the range 30 minutes to 16 hours.</p>
<p>4. To save your change, press</p> 	<p>The display shows:</p> 
<p>5. To return to Channel mode, press three times</p> 	<p>Example of the display:</p> 



Beep loudness

Setup code 33

This procedure controls the volume of ‘beeps’ made by the transceiver.

You can select:

- ‘NORMAL’ (error ‘beeps’ loud, acceptance ‘beeps’ soft)
- ‘SOFT’ (all ‘beeps’ soft)
- ‘LOUD’ (all ‘beeps’ loud).

To change the ‘beep’ loudness:

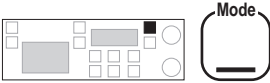
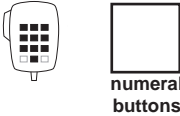
Action	Notes
<p>1. Repeatedly press</p>  <p>until you see the display for Setup mode.</p>	<p>The display shows:</p> <div style="border: 1px solid black; padding: 5px;"> <pre> SETUP MENU 1/2 1-Scan 2-Call 3-Config 4-More EXIT ENTER </pre> </div>
<p>2. Enter 33</p> 	<p>The display looks like one of the following:</p> <div style="border: 1px solid black; padding: 5px; margin-bottom: 10px;"> <pre> Adjust Beep Volume NORMAL Soft and loud beeps EXIT ENTER </pre> </div> <div style="border: 1px solid black; padding: 5px; margin-bottom: 10px;"> <pre> Adjust Beep Volume SOFT Always soft beeps EXIT ENTER </pre> </div> <div style="border: 1px solid black; padding: 5px;"> <pre> Adjust Beep Volume LOUD Always loud beeps EXIT ENTER </pre> </div>

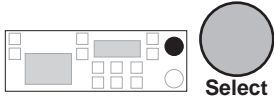
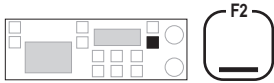
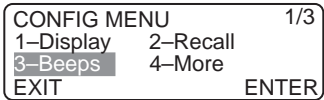
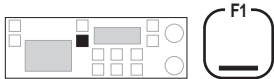
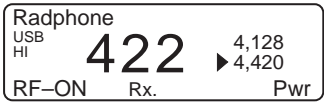
Action	Notes
<p data-bbox="181 220 568 311">3. To switch between 'NORMAL', 'SOFT' and 'LOUD', rotate</p> 	<p data-bbox="636 220 980 248">Select:</p> <ul data-bbox="636 268 980 523" style="list-style-type: none"><li data-bbox="636 268 980 359">• 'NORMAL' if you want loud error 'beeps' and soft acceptance 'beeps'<li data-bbox="636 378 980 443">• 'SOFT' if you always want soft 'beeps'<li data-bbox="636 462 980 523">• 'LOUD' if you always want loud 'beeps'.
<p data-bbox="181 595 561 655">4. To save your change, press</p> 	<p data-bbox="636 595 980 624">The display shows:</p> 
<p data-bbox="181 842 561 903">5. To return to Channel mode, press twice</p> 	<p data-bbox="636 842 980 871">Example of the display:</p> 



Call preamble length (option)

Setup code 242

This procedure sets the length of the preamble transmitted at the start of a selcall or ALE call.



Before you can use this procedure, you need to enable the selcall option (see Chapter 7, Password entry to enable transceiver options).

To send an ALE call, your station needs to be set up with an ALE controller.

The preamble is part of the coded selcall and ALE message structure which is transmitted when you send a call. The preamble allows the receiving station sufficient time to scan to the selected channel and recognise the incoming call. ALE calls need a longer preamble than selcalls.



You can set the preamble for:

- ‘Selcall’
- ‘ALE’.

The ‘Selcall’ preamble lasts six seconds. The ‘ALE’ preamble lasts 12 seconds.

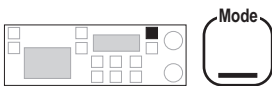
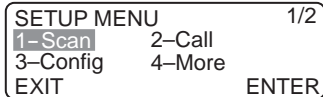
To change the preamble length:

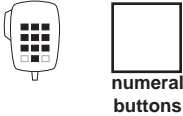
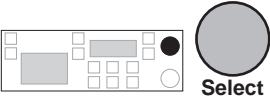
Action	Notes
<p>1. Repeatedly press</p>  <p>until you see the display for Setup mode.</p>	<p>The display shows:</p> 

Action	Notes
<p>2. Enter 242</p> 	<p>The display shows:</p> <div style="border: 1px solid black; padding: 5px; margin-bottom: 10px;"> Setup Call Preamble SELCALL Selcall preamble EXIT ENTER </div> <p>or</p> <div style="border: 1px solid black; padding: 5px;"> Setup Call Preamble ALE ALE preamble EXIT ENTER </div>
<p>3. To switch between 'SELCALL' and 'ALE', rotate</p> 	<p>Select:</p> <ul style="list-style-type: none"> • 'SELCALL' if you are not using an ALE controller • 'ALE' if you are using an ALE controller to send calls.
<p>4. To save your change, press</p> 	<p>The display shows:</p> <div style="border: 1px solid black; padding: 5px;"> CALL MENU 2/3 1-Beacon 2-Preamble 3-ALE 4-More EXIT ENTER </div>
<p>5. To return to Channel mode, press twice</p> 	<p>Example of the display:</p> <div style="border: 1px solid black; padding: 5px;"> Radphone USB HI 422 4,128 RF-ON Rx. ▶ 4,420 Pwr </div>



Call privacy on/off (option)

Setup code 2443

This procedure limits the stations that can receive your transmissions of GPS and page information.



Before you can use this procedure, you need to enable the selcall option (see Chapter 7, Password entry to enable transceiver options).

You switch on call privacy by setting a privacy key (a number up to six digits). This restricts the stations that can receive your information to those using an identical privacy key.

To switch call privacy on or off:

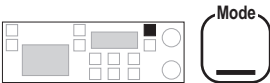
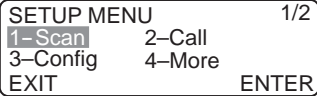
Action	Notes
<p>1. Repeatedly press</p>  <p>until you see the display for Setup mode.</p>	<p>The display shows:</p> 

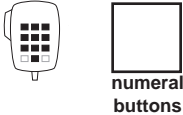
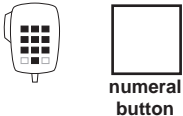
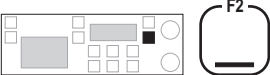
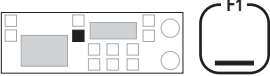
Action	Notes
<p>2. Enter 2443</p> 	<p>If privacy is unset, the privacy key is shown as 0 like this:</p> <div data-bbox="639 296 958 395" style="border: 1px solid black; padding: 5px;"> <p>Enter Privacy Key Key: -----0</p> <p>EXIT ENTER</p> </div> <p>If privacy is set, the privacy key is hidden like this:</p> <div data-bbox="639 512 958 611" style="border: 1px solid black; padding: 5px;"> <p>Enter Privacy Key Key: ******</p> <p>EXIT ENTER</p> </div>
<p>3. Enter the privacy key</p> 	<p>Enter up to six digits.</p> <p>To switch call privacy off, enter 0 for the privacy key.</p>
<p>4. To save your change, press</p> 	<p>The display shows:</p> <div data-bbox="639 978 958 1077" style="border: 1px solid black; padding: 5px;"> <p>CALL MENU 3/3</p> <p>1-Lockout 2-Emgcy</p> <p>3-Privacy 4-More</p> <p>EXIT ENTER</p> </div>
<p>5. To return to Channel mode, press twice</p> 	<p>Example of the display:</p> <div data-bbox="639 1198 958 1297" style="border: 1px solid black; padding: 5px;"> <p>Radphone</p> <p>USB 4,128</p> <p>Hi 422 ▶ 4,420</p> <p>RF-ON Rx. Pwr</p> </div>



Clock calibration

Setup code 412

This procedure calibrates the transceiver clock against an external standard.

The clock is used for timing incoming selective calls recorded in call memory.

You can adjust the running of the clock by changing the number of seconds that the clock gains or loses each month. The calibration range is -150 to +310 seconds/month in steps of 10 (approximate values).

The first time you calibrate the clock, set the value to zero seconds/month. Over a period of a few months, see if the clock gains or loses time and recalibrate as necessary.

To calibrate the clock:

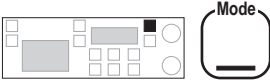
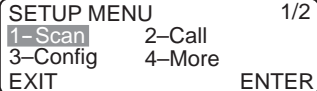
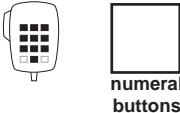
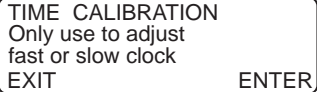
Action	Notes
<p>1. Repeatedly press</p>  <p>until you see the display for Setup mode.</p>	<p>The display shows:</p> 
<p>2. Enter 412</p> 	<p>The display shows:</p> 

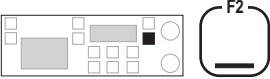
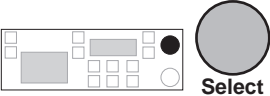
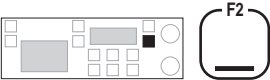
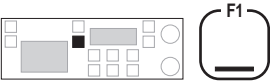
Action	Notes
<p>3. Press</p> 	<p>The display shows the day and time that the calibration was last set:</p> <div data-bbox="639 325 960 422" style="border: 1px solid black; padding: 5px;"> <p>TIME CALIBRATION Last 04/06/96 18:04 +010 sec/month EXIT ->+ ENTER</p> </div>
<p>4. To change the calibration setting, rotate</p> 	<p>The calibration range is -150 to +310 seconds/month in steps of 10.</p> <p>As you change the value, the slider moves at the bottom of the screen—as displayed above.</p>
<p>5. To save your change, press</p> 	<p>The display shows:</p> <div data-bbox="639 852 960 949" style="border: 1px solid black; padding: 5px;"> <p>TIME SETUP MENU 1- Set 2-Calib EXIT ENTER</p> </div>
<p>6. To return to Channel mode, press twice</p> 	<p>Example of the display:</p> <div data-bbox="639 1102 960 1198" style="border: 1px solid black; padding: 5px;"> <p>Radphone USB 422 4,128 Hi 4,420 RF-ON Rx. Pwr</p> </div>



Clock setting

Setup code 411



This procedure sets the time and date of the transceiver clock.

The time is always shown in 24 hour format. The clock is used for timing incoming selective calls recorded in call memory.

To change the clock setting, you must complete the procedure. If you exit the procedure before the end, all changes are lost.

The clock stops during the procedure. When you complete the procedure, it restarts using the new settings.

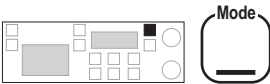
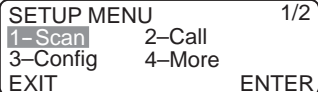
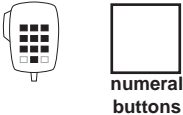
To set the clock:

Action	Notes
<p>1. Repeatedly press</p>  <p>until you see the display for Setup mode.</p>	<p>The display shows:</p> 
<p>2. Enter 411</p> 	<p>The clock stops running. Example of the display:</p> 

Action

Notes

3. Enter the hour if you want to change the hour

Use 24-hour format. For example, enter 18 for 6 pm.

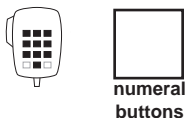

4. Press

Example of the display:

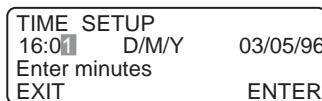
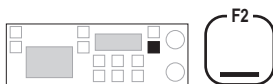

5. Enter the minutes if you want to change the minutes



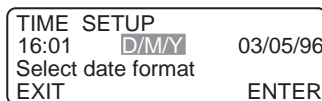

6. Press

Example of the display:

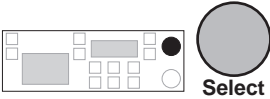
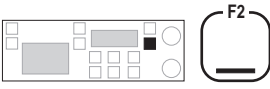
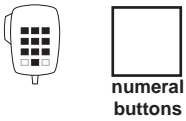
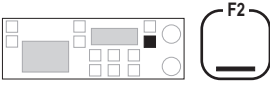

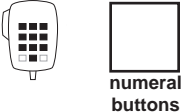
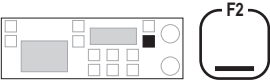
Action	Notes
<p>7. To switch between 'D/M/Y' and 'M/D/Y' date formats, rotate</p> 	<p>Select:</p> <ul style="list-style-type: none"> • 'D/M/Y' for day/month/year • 'M/D/Y' for month/day/year.
<p>8. Press</p> 	<p>Example of the display:</p> <div style="border: 1px solid black; padding: 5px;"> <p>TIME SETUP 16:01 D/M/Y 05/05/96 Enter days EXIT ENTER</p> </div>
<p>9. Enter the day for the 'D/M/Y' format if you want to change the day (or month for the 'M/D/Y' format)</p> 	<p>Example of the display:</p> <div style="border: 1px solid black; padding: 5px;"> <p>TIME SETUP 16:01 D/M/Y 03/05/96 Enter months EXIT ENTER</p> </div>
<p>10. Press</p> 	<p>Example of the display:</p> <div style="border: 1px solid black; padding: 5px;"> <p>TIME SETUP 16:01 D/M/Y 03/05/96 Enter months EXIT ENTER</p> </div>

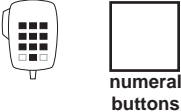
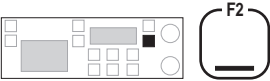
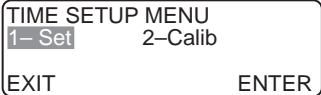
Action	Notes
<p>11. Enter the month for the 'D/M/Y' format if you want to change the month (or day for the 'M/D/Y' format)</p> 	
<p>12. Press</p> 	<p>Example of the display:</p> 
<p>13. Enter the last two digits of the year if you want to change the year</p> 	<p>For example, enter 96 for 1996.</p>
<p>14. To save all changes to the time and date, press</p> 	<p>The clock restarts at the time the F2 button is pressed. The display shows:</p> 

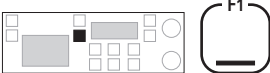
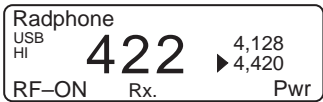
Action	Notes
<p>15. If you are setting the clock for the first time, calibrate the clock.</p>	<p>Set calibration to zero seconds/month. See <i>Clock calibration</i> on page 5-19.</p>
<p>16. To return to Channel mode, press twice</p>	<p>Example of the display:</p>
 <p>The diagram shows a control panel with several buttons and a display area. A specific button is highlighted with a circle and labeled 'F1'.</p>	 <p>The display shows the following information:</p> <ul style="list-style-type: none"> Radphone USB HI 422 4,128 4,420 RF-ON Rx. Pwr



Clone a transceiver

This procedure copies the settings from one 9390 transceiver to another by a process called cloning. Cloning allows you to set up several 9390 transceivers that all work in exactly the same way.



You clone transceivers by connecting the microphone socket of the transceiver which is already set up to the microphone socket of a transceiver which is to be cloned.



You can obtain the cable required for this procedure from an authorised Codan dealer (Codan part no. 08-05138-001).

Except for the PIN and the self ID, the cloning procedure overwrites all settings in the transceiver you are copying into.

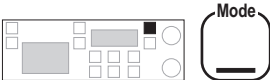
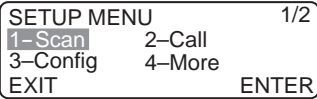
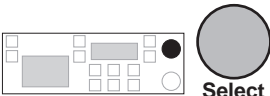
To clone a transceiver:

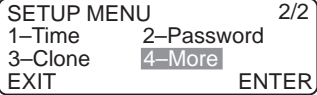
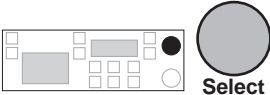
Action	Notes
1. Use the Cloning cable to join the microphone sockets of the two transceivers.	
2. Switch on both transceivers.	

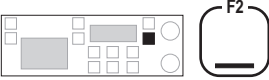
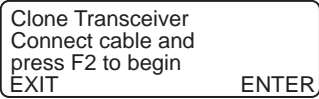
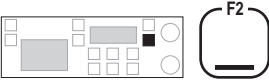
- | Action | Notes |
|---|--|
| <p>3. On the master transceiver you are cloning from, repeatedly press</p>  <p>until you see the display for Setup mode.</p> | <p>The display shows:</p>  |
| <p>4. Select '4-More' by rotating</p>  | |
| <p>5. Press</p>  | <p>The display shows:</p>  |
| <p>6. Select '3-Clone' by rotating</p>  | |

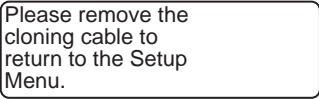
Action	Notes
<p>7. Press</p> 	<p>The display shows:</p> 
<p>8. To start the transfer of information, press</p> 	<p>The display shows:</p>  <p>After about two minutes, cloning finishes and the master transceiver 'beeps' twice. The display shows:</p> 
<p>9. Disconnect the cable and switch off both transceivers.</p>	



6 Setup procedures (part 2)

This chapter describes the following Setup mode procedures:

- Display brightness (6-2)
- Display contrast (6-4)
- Display frequency (6-4)
- Free-Tune Receiver mode availability on/off (6-6)
- GPS display on/off (option, 6-11)
- GPS timeout on/off (option, 6-13).

Display brightness



Setup code 311

This procedure controls the brightness of the display.

You can also adjust the brightness of the display using the **On/Off** button on the control panel (refer to the *9390 User guide, Chapter 4, Adjusting the display brightness*).

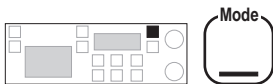
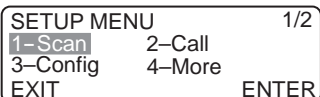
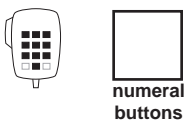
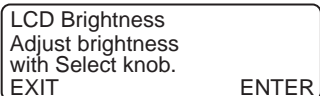
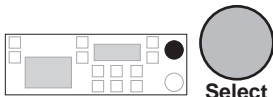
To adjust the brightness of the display:

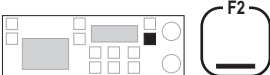
Action	Notes
<p>1. Repeatedly press</p>  <p>until you see the display for Setup mode.</p>	<p>The display shows:</p> 
<p>2. Enter 311</p> 	<p>The display shows:</p> 
<p>3. To adjust the brightness, rotate</p> 	

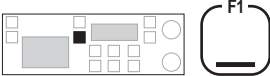
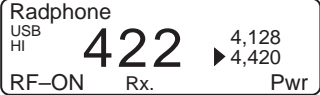
Action	Notes
<p>4. To save your change, press</p> 	<p>The display shows:</p> 
<p>5. To return to Channel mode, press three times</p> 	<p>Example of the display:</p> 



Display contrast



Setup code 312

This procedure controls the contrast of the display.

You can also adjust the contrast of the display using the **On/Off** button on the control panel (refer to the *9390 User guide, Chapter 4, Adjusting the display contrast*).

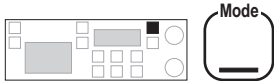
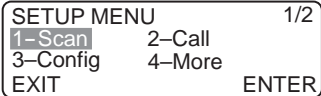
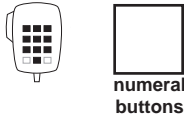
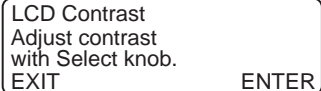
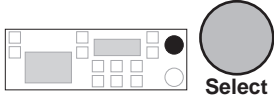
To adjust the contrast of the display:

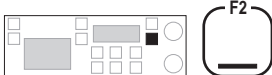
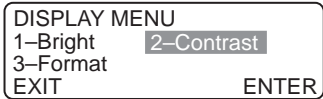
Action	Notes
<p>1. Repeatedly press</p>  <p>until you see the display for Setup mode.</p>	<p>The display shows:</p> 
<p>2. Enter 312</p> 	<p>The display shows:</p> 
<p>3. To adjust the contrast, rotate</p> 	

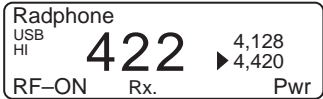
Action	Notes
<p>4. To save your change, press</p> 	<p>The display shows:</p> 
<p>5. To return to Channel mode, press three times</p> 	<p>Example of the display:</p> 



Display frequency

Setup code 313

This procedure controls how the frequency is displayed for each channel.

You can select:

- ‘RX/TX’
- ‘INHIBIT’
- ‘RX ONLY’



For two-frequency simplex channels, the ‘RX/TX’ setting displays the transmit frequency above the receive frequency. An arrow on the screen moves from the receive frequency to the transmit frequency during transmission. For other channels where the transmit and receive frequencies are the same, this setting displays the single frequency.

The ‘INHIBIT’ setting displays no frequency for any channel.

The ‘RX ONLY’ setting displays the frequency in use, whether single frequency or two-frequency simplex, which changes to the transmit frequency during transmission.

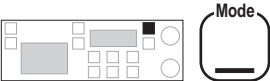
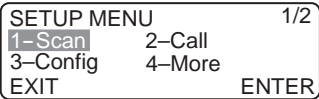
To change how the channel frequency is displayed:

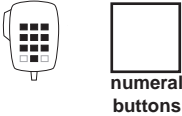
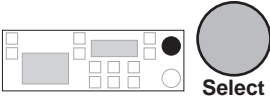
Action	Notes
<p>1. Repeatedly press</p>  <p>until you see the display for Setup mode.</p>	<p>The display shows:</p> 

Action	Notes
<p data-bbox="239 220 449 244">2. Enter 313</p> 	<p data-bbox="689 220 1003 277">The display shows one of the following:</p> <div data-bbox="692 300 1012 395" style="border: 1px solid black; padding: 5px;"> <p data-bbox="701 300 900 323">Freq. display format</p> <p data-bbox="766 323 835 347">RX/TX</p> <p data-bbox="701 347 909 371">Show Tx and Rx freq</p> <p data-bbox="701 371 1003 395">EXIT ENTER</p> </div> <div data-bbox="692 418 1012 513" style="border: 1px solid black; padding: 5px;"> <p data-bbox="701 418 900 442">Freq. display format</p> <p data-bbox="766 442 853 466">INHIBIT</p> <p data-bbox="701 466 909 489">Show no frequencies</p> <p data-bbox="701 489 1003 513">EXIT ENTER</p> </div> <div data-bbox="692 536 1012 632" style="border: 1px solid black; padding: 5px;"> <p data-bbox="701 536 900 560">Freq. display format</p> <p data-bbox="766 560 864 584">RX ONLY</p> <p data-bbox="701 584 887 608">Show Rx freq. only</p> <p data-bbox="701 608 1003 632">EXIT ENTER</p> </div>
<p data-bbox="239 707 583 764">3. To switch between the settings, rotate</p> 	<p data-bbox="689 707 762 730">Select:</p> <ul data-bbox="689 754 992 1007" style="list-style-type: none"> <li data-bbox="689 754 992 847">• 'RX/TX' to display both transmit and receive frequencies <li data-bbox="689 871 992 928">• 'INHIBIT' to display no frequencies <li data-bbox="689 952 992 1007">• 'RX ONLY' to display receive frequency only.
<p data-bbox="239 1082 570 1139">4. To save your change, press</p> 	<p data-bbox="689 1082 897 1106">The display shows:</p> <div data-bbox="692 1128 1012 1224" style="border: 1px solid black; padding: 5px;"> <p data-bbox="701 1128 864 1152">DISPLAY MENU</p> <p data-bbox="701 1152 949 1176">1-Bright 2-Contrast</p> <p data-bbox="701 1176 801 1200">3-Format</p> <p data-bbox="701 1200 1003 1224">EXIT ENTER</p> </div>

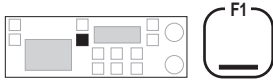
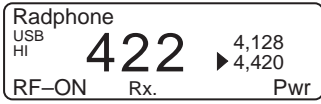
Action	Notes
<p data-bbox="182 220 543 279">5. To return to Channel mode, press three times</p> 	<p data-bbox="636 220 957 247">Example of the display:</p> 





Free-Tune Receiver mode availability on/off



Setup code 3442

This procedure controls the availability of Free-Tune Receiver mode.

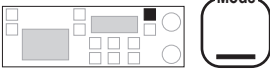
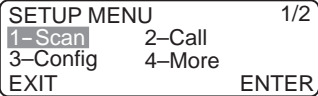
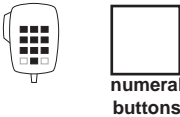
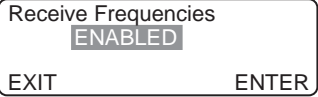
Free-Tune Receiver mode allows you to tune the receiver to any frequency in its operating frequency range.

To switch the availability of Free-Tune Receiver mode on or off:

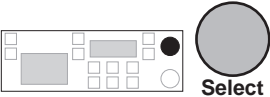
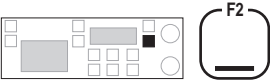
Action	Notes
<p>1. Repeatedly press</p>  <p>until you see the display for Setup mode.</p>	<p>The display shows:</p> 
<p>2. Enter 3442</p> 	<p>The display shows:</p>  <p>or</p> 

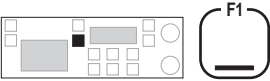
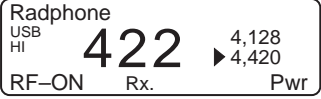
Action	Notes
<p>3. To switch between 'ENABLED' and 'DISABLED', rotate</p> 	<p>Select:</p> <ul style="list-style-type: none"> • 'ENABLED' if you want to be able to tune the transceiver to any receive frequency • 'DISABLED' if you only want to tune the transceiver to set channel receive frequencies.
<p>4. To save your change, press</p> 	<p>The display shows:</p> 
<p>5. To return to Channel mode, press twice</p> 	<p>Example of the display:</p> 



GPS display on/off (option)

Setup code 3421



This procedure switches on or off the display of your transceiver's GPS (Global Positioning System) latitude and longitude.

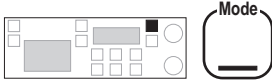
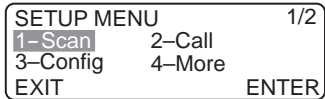
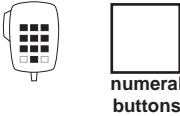
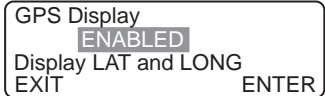
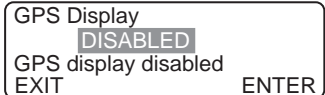

Before you can use this procedure, you need to enable both the selcall and GPS options (see Chapter 7, Password entry to enable transceiver options).

To switch the displaying of GPS information on or off:

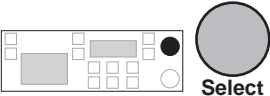
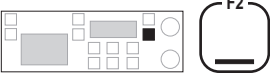
Action	Notes
<p>1. Repeatedly press</p>  <p>until you see the display for Setup mode.</p>	<p>The display shows:</p> 
<p>2. Enter 3421</p> 	<p>The display shows:</p>  <p>or</p> 

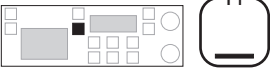
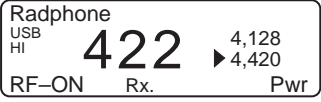
Action	Notes
<p>3. To switch between 'ENABLED' and 'DISABLED', rotate</p> 	<p>Select:</p> <ul style="list-style-type: none"> • 'ENABLED' if you want to display GPS latitude and longitude • 'DISABLED' if you do not want to display GPS information.
<p>4. To save your change, press</p> 	<p>The display shows:</p> 
<p>5. To return to Channel mode, press three times</p> 	<p>Example of the display:</p> 



GPS timeout on/off (option)

Setup code 3422

This procedure switches GPS (Global Positioning System) timeout warning on or off.



Before you can use this procedure, you need to enable both the selcall and GPS options (see Chapter 7, Password entry to enable transceiver options).



When GPS timeout is switched on, the transceiver ‘beeps’ if it does not receive GPS information within the set time.

You can select:

- ‘5 mins’
- ‘10 mins’
- ‘15 mins’
- ‘20 mins’
- ‘35 mins’
- ‘OFF’ (no error ‘beep’).

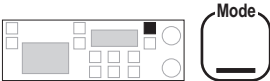
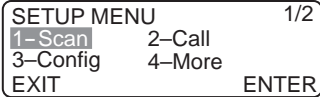
To switch GPS timeout on or off:

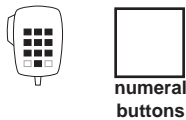
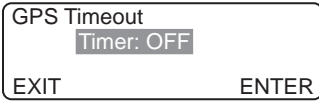
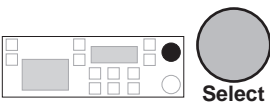
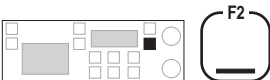
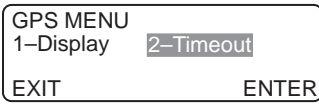
Action	Notes
1. Repeatedly press	The display shows:
	
until you see the display for Setup mode.	

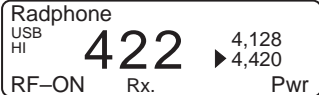
Action	Notes
<p>2. Enter 3422</p> 	<p>If GPS timeout is switched off, the display shows:</p>  <p>If GPS timeout is switched on, the current programmed time setting is displayed.</p>
<p>3. To change the error 'beep' setting, rotate</p> 	<p>Select:</p> <ul style="list-style-type: none"> • on with a time in the range 5–35 minutes. • off.
<p>4. To save your change, press</p> 	<p>The display shows:</p> 
<p>5. To return to Channel mode, press three times</p> 	<p>Example of the display:</p> 



7 Setup procedures (part 3)

This chapter describes the following Setup mode procedures:

- Password entry to enable transceiver options (7-2)
- Power up message on/off (7-8)
- Power up mute setting (7-11)
- Power up selcall self ID display on/off (option, 7-14)
- PTT release beep on/off (7-16)
- PTT transmit cutout (7-18)
- Recall channels by frequency on/off (7-20)
- RF gain on/off (7-22)
- RS-232 connected equipment (7-24)
- RS-232 connection baud rate (7-27).

Password entry to enable transceiver options

Setup code 42

This procedure allows you to:

- display your transceiver ID
- enable transceiver options that are built into the transceiver
- delete your PIN if you have forgotten it.

By using passwords, you can purchase additional features for your transceiver without the need to return the unit to your Codan agent.

You obtain passwords from your Codan agent. There is a separate password for each transceiver option. Passwords are unique to your transceiver. You cannot use your transceiver's passwords with a different transceiver.

Enabling transceiver options

The table below lists the passwords available from Codan for enabling transceiver options.

Password	Option
ALE	Allows you to add an ALE controller to your system so that you can send and receive ALE calls. Refer to the <i>9390 User guide, Chapter 5, ALE call</i> . The selcall option must be enabled.
AM	Allows you to transmit on AM using any of the transceiver's transmit channels. If AM is not enabled, you can only transmit on AM using the 2182kHz marine distress frequency on channel 1.



Password	Option
GPS	Allows your transceiver to send and receive GPS position and GPS beacon calls. The selcall option must be enabled.
S (Selcall)	Allows your transceiver to send and receive selective calls (beacon, telcall, selcall and page).
SL (Selcall Lockout)	Selcall lockout reduces call interference. It applies to all types of selective call (beacon, selcall, telcall, GPS, page and ALE). Refer to the <i>9390 User guide, Chapter 7, Selcall lockout</i> . The selcall option must be enabled.

After you have enabled an option, you may need to use other Setup mode procedures to enter settings that control the option.

You can remove an enabled option by repeating the procedure and entering the password again.

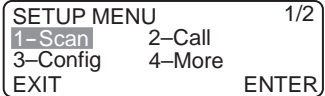
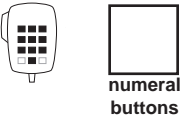
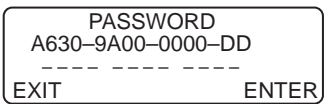
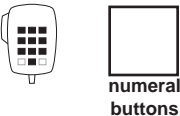
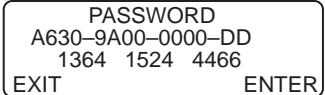
To enable a transceiver option:

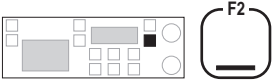
Action	Notes
<p>1. Repeatedly press</p>  <p>until you see the display for Setup mode.</p>	<p>The display shows:</p> 
<p>2. Enter 42</p> 	<p>The display shows your transceiver 14-digit ID. Example of the display:</p> 
<p>3. Contact your Codan agent and request the password for the transceiver option you want to enable.</p>	<p>The Codan agent will ask you for personal identification and your transceiver ID.</p>
<p>4. Enter the password</p> 	<p>Example of the display:</p> 

Action	Notes
<p data-bbox="240 220 397 247">5. Press</p> 	<p data-bbox="688 220 1030 343">If the password is incorrect, the transceiver ‘beeps’ and switches off after displaying this for three seconds:</p> <div data-bbox="694 359 1013 454" style="border: 1px solid black; padding: 5px;"> <pre> PASSWORD INVALID A630-9A00-0000-DD ----- 1 2 3 EXIT ENTER </pre> </div>
<p data-bbox="240 805 565 869">6. To return to Channel mode, press</p> 	<p data-bbox="688 805 946 837">Example of the display:</p> <div data-bbox="694 853 1013 957" style="border: 1px solid black; padding: 5px;"> <pre> Radphone USB HI 422 4,128 RF-ON Rx. Pwr 4,420 </pre> </div>

Deleting a PIN

If the transceiver is set up with a PIN but you cannot remember it, you will not be able to use the transceiver. You will need to obtain the PIN Deletion password from your Codan agent. This password allows you to delete the PIN when you switch on the transceiver.

To delete a forgotten PIN:

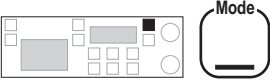
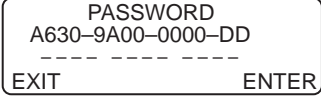
Action	Notes
<p>1. Switch on the transceiver.</p>	<p>The display shows:</p> 
<p>2. Press</p> 	<p>The display shows your transceiver 14-digit ID. Example of the display:</p>  <p>Pressing the Mode button again returns you to the PIN entry screen.</p>
<p>3. Contact your Codan agent and request the PIN deletion password.</p>	<p>The Codan agent will ask you for personal identification and your transceiver ID.</p>

Action

Notes

- 4. Enter the PIN deletion password

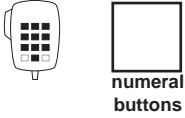

- 5. Press

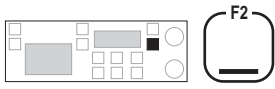

If the password is incorrect, the transceiver 'beeps' and switches off after displaying this for three seconds:

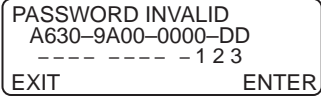

If the password is correct, the transceiver enters Channel mode after displaying this for 10 seconds:

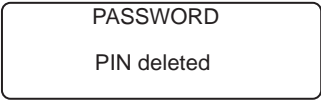

To set up a new PIN, see *Chapter 9, PIN setup*.





Power up message on/off

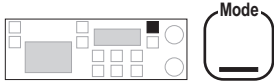
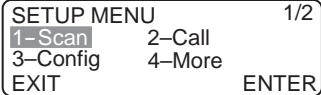
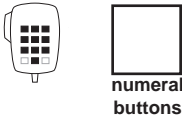

Setup code 34411

This procedure allows you to set up a message which is displayed for several seconds when the transceiver is first switched on (powered).

To set or cancel a power up message:

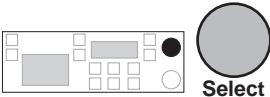
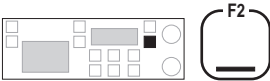
Action	Notes
<p>1. Repeatedly press</p>  <p>until you see the display for Setup mode.</p>	<p>The display shows:</p> 
<p>2. Enter 34411</p> 	<p>The display shows:</p>  <p>or</p> 

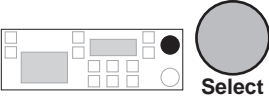
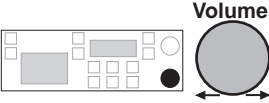
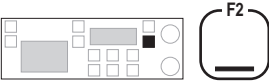
Action	Notes
<p>3. To switch between 'ENABLED' and 'DISABLED', rotate</p> 	<p>Select:</p> <ul style="list-style-type: none"> 'ENABLED' if you want to display a message when you switch on the transceiver 'DISABLED' if you do not want to display a message when you switch on the transceiver.
<p>4. To save your change, press</p> 	<p>If you selected 'ENABLED':</p> <div data-bbox="694 622 1013 718" style="border: 1px solid black; padding: 5px;"> <p>Power Up Message ----- Modify message CLEAR ENTER</p> </div> <p>If you selected 'DISABLED':</p> <div data-bbox="694 790 1013 885" style="border: 1px solid black; padding: 5px;"> <p>POWER UP MENU 1-Message 2-Mute 3-Show ID EXIT ENTER</p> </div>
<p>5. Did you select 'ENABLED' to display a power up message?</p> <p>Yes ➤ Step 6.</p> <p>No ➤ Step 8.</p>	

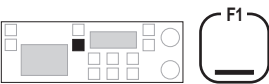
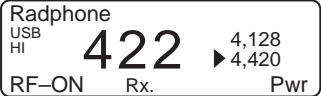
Action	Notes
<p data-bbox="181 220 524 277">6. To enter the message, rotate</p>  <p data-bbox="288 427 538 485">to select each character and</p>  <p data-bbox="288 632 555 718">to move along the line to the next character position.</p>	<p data-bbox="636 220 911 248">Enter up to 20 characters.</p> <p data-bbox="636 268 984 300">To clear any existing text, press</p>
<p data-bbox="181 794 524 852">7. To save your change, press</p> 	<p data-bbox="636 794 844 823">The display shows:</p> 
<p data-bbox="181 1040 542 1098">8. To return to Channel mode, press three times</p> 	<p data-bbox="636 1040 891 1069">Example of the display:</p> 



Power up mute setting



Setup code 34412



This procedure controls the initial mute setting used when the transceiver is switched on (powered).

You can select:

- ‘NO MUTE’
- ‘AUDIO MUTE’
- ‘SELCALL MUTE’ (if selcall mute availability is switched on, see *Chapter 8, Selcall mute availability on/off*).

To change the initial mute setting used when the transceiver is powered:

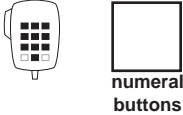
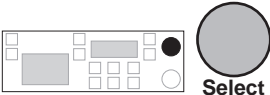
Action	Notes						
1. Repeatedly press <div data-bbox="344 871 613 954" style="display: flex; align-items: center; margin-top: 10px;">  <div style="margin-left: 10px;">  </div> </div> <p data-bbox="342 986 600 1043">until you see the display for Setup mode.</p>	<p>The display shows:</p> <div data-bbox="694 871 1014 963" style="border: 1px solid black; padding: 5px; margin-top: 10px;"> <div style="display: flex; justify-content: space-between;"> SETUP MENU 1/2 </div> <table style="width: 100%; border-collapse: collapse;"> <tr> <td style="padding: 2px;">1-Scan</td> <td style="padding: 2px;">2-Call</td> </tr> <tr> <td style="padding: 2px;">3-Config</td> <td style="padding: 2px;">4-More</td> </tr> <tr> <td style="padding: 2px;">EXIT</td> <td style="padding: 2px; text-align: right;">ENTER</td> </tr> </table> </div>	1-Scan	2-Call	3-Config	4-More	EXIT	ENTER
1-Scan	2-Call						
3-Config	4-More						
EXIT	ENTER						

Action	Notes
<p>2. Enter 34412</p> 	<p>The display shows one of the following:</p> <div style="border: 1px solid black; padding: 5px; margin-bottom: 5px;"> <p>Mute Power Up NO MUTE</p> <p>EXIT ENTER</p> </div> <div style="border: 1px solid black; padding: 5px; margin-bottom: 5px;"> <p>Mute Power Up AUDIO MUTE</p> <p>EXIT ENTER</p> </div> <div style="border: 1px solid black; padding: 5px;"> <p>Mute Power Up SELCALL MUTE</p> <p>EXIT ENTER</p> </div>
<p>3. To switch between the settings, rotate</p> 	<p>Select:</p> <ul style="list-style-type: none"> • ‘NO MUTE’ if you want no muting on power switch on • ‘AUDIO MUTE’ if you want voice muting on power switch on • ‘SELCALL MUTE’ if you want selcall muting on power switch on.
<p>4. To save your change, press</p> 	<p>The display shows:</p> <div style="border: 1px solid black; padding: 5px;"> <p>POWER UP MENU 1–Message 2–Mute 3–Show ID EXIT ENTER</p> </div>

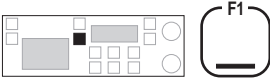
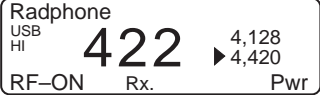
Action	Notes
<p>5. To return to Channel mode, press three times</p> 	<p>Example of the display:</p> 



Power up selcall self ID display on/off (option)





Setup code 34413



This procedure controls whether the self ID set up in selcall group 1 is displayed when the transceiver is switched on (powered).

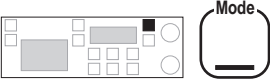

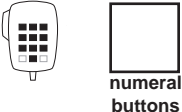
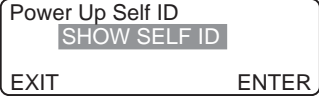
Before you can use this procedure, you need to enable the selcall option (see Chapter 7, Password entry to enable transceiver options).

To switch the display of the self ID on or off when the transceiver is powered:

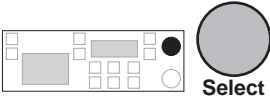
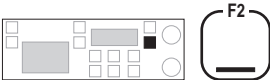
Action	Notes
<p>1. Repeatedly press</p>  <p>until you see the display for Setup mode.</p>	<p>The display shows:</p> 
<p>2. Enter 34413</p> 	<p>The display shows:</p>  <p>or</p> 

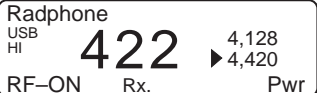
Action	Notes
<p>3. To switch between 'SHOW SELF ID' and 'HIDE SELF ID', rotate</p> 	<p>Select:</p> <ul style="list-style-type: none"> • 'SHOW SELF ID' if you want to display the self ID on power switch on • 'HIDE SELF ID' if you do not want to display the self ID on power switch on.
<p>4. To save your change, press</p> 	<p>The display shows:</p> 
<p>5. To return to Channel mode, press three times</p> 	<p>Example of the display:</p> 







PTT release beep on/off

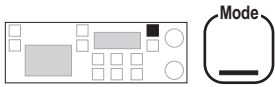
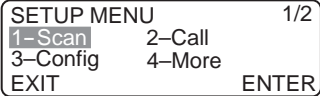

Setup code 3432

The transceiver's PTT release 'beep' feature saves you from having to say 'over' every time you release the **PTT** button. This procedure switches PTT release 'beeping' on or off.

When you switch PTT release 'beeping' on, the transceiver automatically indicates that you have finished talking by sending a 'beep' every time you release the **PTT** button. You do not hear the 'beeps' at your station.

To switch PTT release 'beeping' on or off:

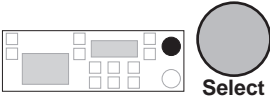
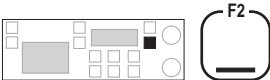
Action	Notes
<p>1. Repeatedly press</p>  <p>until you see the display for Setup mode.</p>	<p>The display shows:</p> 
<p>2. Enter 3432</p>   <p>numeral buttons</p>	<p>The display shows:</p>  <p>or</p> 

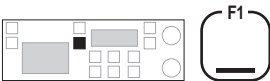
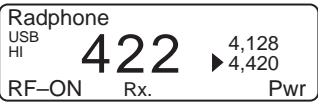
Action	Notes
<p>3. To switch between 'ENABLED' and 'DISABLED', rotate</p> 	<p>Select:</p> <ul style="list-style-type: none"> • 'ENABLED' to make the transceiver 'beep' when you release the PTT button • 'DISABLED' to stop the transceiver 'beeping' when you release the PTT button.
<p>4. To save your change, press</p> 	<p>The display shows:</p> 
<p>5. To return to Channel mode, press three times</p> 	<p>Example of the display:</p> 



PTT transmit cutout

Setup code 3431

This procedure prevents the transceiver from being left on in the transmit state by mistake.

If the transmit time exceeds the time set for PTT transmit cutout, the transceiver switches to receive and displays an error message.





This cutout does not apply to any equipment connected to the **GP** connector.

You can select:

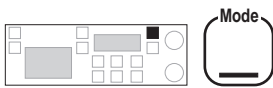
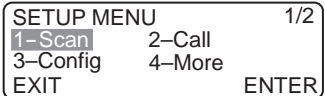
- 'OFF' (transmission never cuts out)
- '5 mins'
- '10 mins'
- '15 mins'
- '20 mins'
- '35 mins'.

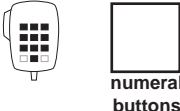
To set the PTT transmit cutout time:

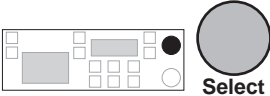
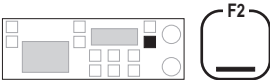
Action	Notes
<p>1. Repeatedly press</p>  <p>until you see the display for Setup mode.</p>	<p>The display shows:</p> 

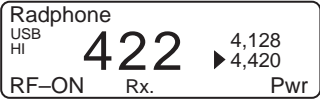
Action	Notes
2. Enter 3431	Example of the display:
	
3. To set the cutout time, rotate	Select:
	<ul style="list-style-type: none"> • 'OFF' • a time in the range 5–35 minutes.
4. To save your change, press	The display shows:
	
5. To return to Channel mode, press three times	Example of the display:
	





Recall channels by frequency on/off

Setup code 32

This procedure controls whether you can recall channels by frequency in addition to channel number.

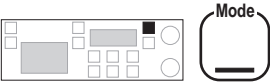
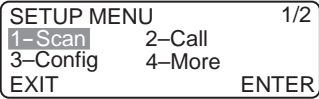
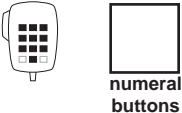
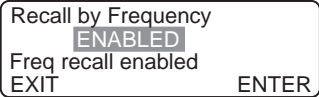
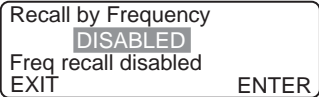
To switch the recalling of channels by frequency on or off:

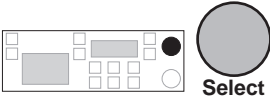
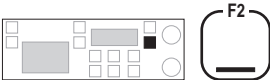
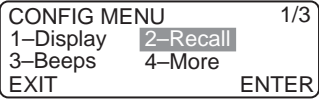
Action	Notes
<p>1. Repeatedly press</p>  <p>until you see the display for Setup mode.</p>	<p>The display shows:</p> 
<p>2. Enter 32</p> 	<p>The display shows:</p>  <p>or</p> 

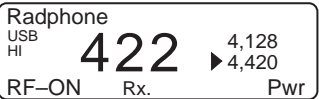
Action	Notes
<p>3. To switch between 'ENABLED' and 'DISABLED', rotate</p> 	<p>Select:</p> <ul style="list-style-type: none"> 'ENABLED' to allow channel recall by frequency as well as channel number 'DISABLED' to only allow channel recall by channel number.
<p>4. To save your change, press</p> 	<p>The display shows:</p> 
<p>5. To return to Channel mode, press twice</p> 	<p>Example of the display:</p> 



RF gain on/off



Setup code 3443



This procedure controls the RF gain to change the receive sensitivity of the transceiver.

Switch RF gain on for a ship station or for an area where electrical interference is low. Switch RF gain off for a coast station that has large antennas or for an area where electrical interference is high.

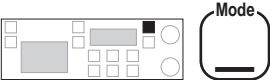
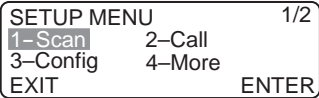
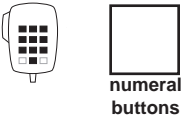
You can also change the RF gain using the **F1** button on the control panel (refer to the *9390 User guide, Chapter 4, Changing RF gain*).

To switch RF gain on or off:

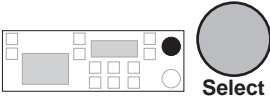
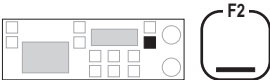
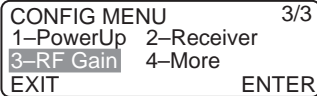
Action	Notes
<p>1. Repeatedly press</p>  <p>until you see the display for Setup mode.</p>	<p>The display shows:</p> 
<p>2. Enter 3443</p> 	<p>The display shows:</p>  <p>or</p> 

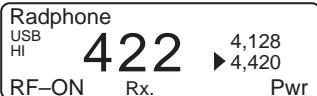
Action	Notes
<p>3. To switch between 'RF gain ON' and 'OFF', rotate</p> 	<p>Select:</p> <ul style="list-style-type: none"> • 'ON' for a ship station or for an area where electrical interference is low. • 'OFF' for a coast station or for an area where electrical interference is high.
<p>4. To save your change, press</p> 	<p>The display shows:</p> 
<p>5. To return to Channel mode, press twice</p> 	<p>Example of the display:</p> 



RS-232 connected equipment

Setup code 3411

This procedure controls what equipment is connected to either the **RS232** socket or **GP** connector on the transceiver rear panel.

Select:

- ‘NONE’ (if nothing is connected)
- ‘COMPUTER’ (if a computer is connected)
- ‘GPS NMEA-0183’ (if the GPS option has been enabled and a GPS receiver is connected)
- ‘9300 ALE’ (if a controller is connected).

To change the setting for the equipment connected to the **RS232** socket or **GP** connector:

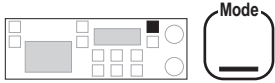
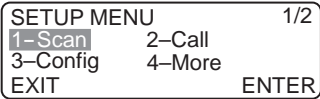
Action	Notes
1. Repeatedly press	The display shows:
	
until you see the display for Setup mode.	

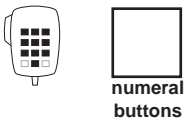
Action	Notes
<p data-bbox="235 215 459 247">2. Enter 3411</p> 	<p data-bbox="688 215 896 247">The display shows:</p> <div data-bbox="688 263 1013 367" style="border: 1px solid black; padding: 5px;"><p data-bbox="700 263 896 295">RS232 Mode Setup</p><p data-bbox="700 295 845 327">None</p><p data-bbox="700 327 845 359">No connection</p><p data-bbox="700 359 1008 367">EXIT ENTER</p></div> <p data-bbox="688 391 716 414">or</p> <div data-bbox="688 430 1013 534" style="border: 1px solid black; padding: 5px;"><p data-bbox="700 430 896 462">RS232 Mode Setup</p><p data-bbox="700 462 868 494">Computer</p><p data-bbox="700 494 907 526">Computer connected</p><p data-bbox="700 526 1008 534">EXIT ENTER</p></div> <p data-bbox="688 550 1036 646">Other screens may be displayed if you have enabled ALE and GPS options.</p>

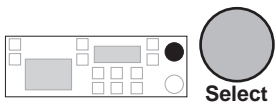
<p data-bbox="235 710 582 774">3. To switch between the settings, rotate</p> 	<p data-bbox="688 710 767 742">Select:</p> <ul data-bbox="688 758 1036 1101" style="list-style-type: none"><li data-bbox="688 758 1036 821">• 'NONE' if nothing is connected<li data-bbox="688 837 1036 901">• 'COMPUTER' if a computer is connected<li data-bbox="688 917 1036 1013">• 'GPS NMEA-0183' if GPS has been enabled and a GPS receiver is connected<li data-bbox="688 1029 1036 1101">• '9300 ALE' if an ALE controller is connected.
---	--

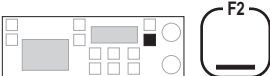
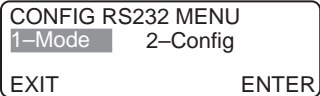
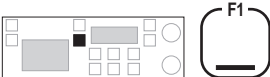
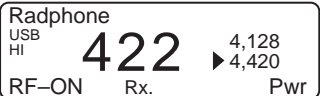
Action	Notes
4. To save your change, press	The display shows:
	
5. To return to Channel mode, press three times	Example of the display:
	



RS-232 connection baud rate

Setup code 3412

This procedure sets the speed of information transfer for equipment connected to either the **RS232** socket or **GP** connector on the transceiver rear panel.





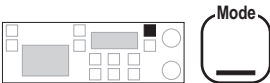
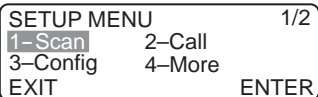

You can select for the baud rate:

- '300'
- '600'
- '1200'
- '2400'
- '4800'
- '9600'.

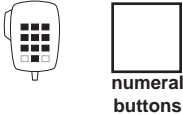
For a GPS receiver, the baud rate is usually 4800. For a computer or an ALE controller, the baud rate is usually 9600.

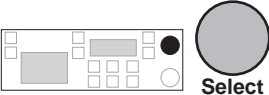
To set the baud rate for the **RS232** socket and **GP** connector:

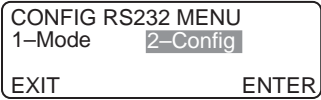
Action	Notes
<p>1. Repeatedly press</p>  <p>until you see the display for Setup mode.</p>	<p>The display shows:</p> 

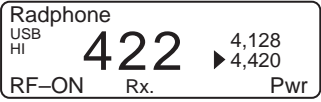
Action	Notes
<p>2. Enter 3412</p>  <p>numeral buttons</p>	<p>Example of the display:</p> 
<p>3. To select the baud rate, rotate</p>  <p>Select</p>	<p>Select the same baud rate used by the connected equipment in the range 300–9600.</p>
<p>4. To save your change, press</p>  <p>F2</p>	<p>The display shows:</p> 
<p>5. To return to Channel mode, press three times</p>  <p>F1</p>	<p>Example of the display:</p> 



8 Setup procedures (part 4)

This chapter describes the following Setup mode procedures:

- Scan table automatic scanning start (8-2)
- Scan table editing on/off (8-4)
- Selcall ID setup (option, 8-6)
- Selcall ID size compatibility (option, 8-13)
- Selcall lockout on/off (option, 8-16)
- Selcall mute availability on/off (option, 8-19)
- Telcall availability on/off (option, 8-21)
- Tone call setup (8-23)
- 99-beacon call response on/off (option, 8-26).

Scan table automatic scanning start

Setup code 11

This procedure sets the time delay to resume automatic scanning after the receipt of a call.



When you do not touch any button or knob for longer than this delay time, the transceiver automatically starts scanning.

If you have set up any of the three scan tables for ALE scanning, it uses the scan table last used in scanning. If you have not set up any scan table for ALE scanning, it uses scan table 1.

You can switch automatic scanning:

- on with a 1–10 minute time delay
- off.

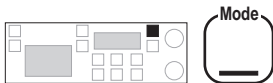
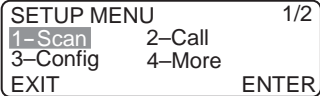
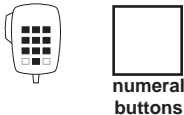
To switch automatic scanning on or off:

Action	Notes
<p>1. Repeatedly press</p>  <p>until you see the display for Setup mode.</p>	<p>The display shows:</p> 
<p>2. Enter 11</p> 	<p>Example of the display:</p> 

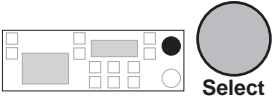
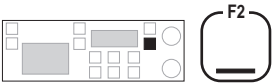
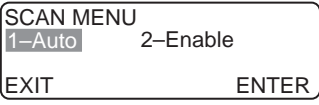
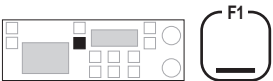
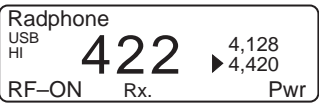
Action	Notes
<p>3. To change the automatic scanning setting, rotate</p> 	<p>Select:</p> <ul style="list-style-type: none"> • 'On' with a 1–10 minute time delay, adjusted in steps of 1 minute • 'Off'.
<p>4. To save your change, press</p> 	<p>The display shows:</p> 
<p>5. To return to Channel mode, press twice</p> 	<p>Example of the display:</p> 



Scan table editing on/off

Setup code 12

This procedure switches scan table editing on or off.



After you have set up your scan tables, switching scan table editing off safeguards against accidentally deleting or modifying scan table information. For details on setting up scan tables, see *Chapter 3, Creating a scan table*.

When scan table editing is switched off:

- you cannot set up, delete or modify any scan table
- you cannot use the transceiver's automatic scanning start feature if no scan tables have been set up (see *Scan table automatic scanning start* on page 8-2).

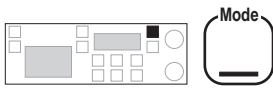
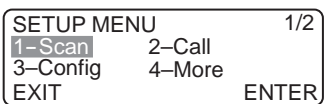
To switch scan table editing on or off:

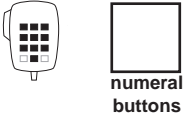
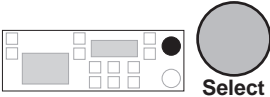
Action	Notes
<p>1. Repeatedly press</p>  <p>until you see the display for Setup mode.</p>	<p>The display shows:</p> 

Action	Notes
<p>2. Enter 12</p> 	<p>The display shows:</p> <div style="border: 1px solid black; padding: 5px; margin-bottom: 10px;"> <p>Scan programming ENABLED Scan program enabled EXIT ENTER</p> </div> <p>or:</p> <div style="border: 1px solid black; padding: 5px;"> <p>Scan programming DISABLED Scan program disabled EXIT ENTER</p> </div>
<p>3. To switch between 'ENABLED' and 'DISABLED', rotate</p> 	<p>Select:</p> <ul style="list-style-type: none"> • 'ENABLED' to switch on scan table editing • 'DISABLED' to switch off scan table editing.
<p>4. To save your change, press</p> 	<p>The display shows:</p> <div style="border: 1px solid black; padding: 5px;"> <p>SCAN MENU 1-Auto 2-Enable EXIT ENTER</p> </div>
<p>5. To return to Channel mode, press twice</p> 	<p>Example of the display:</p> <div style="border: 1px solid black; padding: 5px;"> <p>Radphone USB HI 422 ▶ 4,128 RF-ON Rx. Pwr 4,420</p> </div>



Selcall ID setup (option)

Setup code 211



This procedure sets up IDs for any of the transceiver's five selcall groups S1–S5.

Before you can use this procedure, you need to enable the selcall option (see Chapter 7, Password entry to enable transceiver options).

Having set up a selcall group, you can assign the group to any channel. This allows you to set up your transceiver with several IDs so that you can operate in more than one network.

You can set up any selcall group. To find out the selcall group assigned to each channel in the transceiver, refer to the *9390 User guide, Chapter 4, Using View Channel Options mode*.

A selcall group for normal selective calling consists of:

- a self ID
- an optional called ID
- the selcall type set to 'Codan'
- an optional comment describing the selcall group.

The self ID is equivalent to the telephone number of your station. Do not use a self ID ending with 00 or 99 since these IDs are reserved for sending group and 99-beacon calls.

The called ID is the address of the station to be called. It is usually left unset in your transceiver to allow stations to be selected when the call is made.

If you set a called ID for the selcall group, you will automatically call the station with this ID every time you send a selective call on a channel programmed with this selcall group. If you then want to call a different station on this channel, you will need to change or cancel this called ID setting. Fixing the called ID in this way is useful for ship stations that only ever need to call a coast station.

The selcall type describes the type of selcall group. For normal selective calling between stations, use the 'Codan' selcall type. If you want to set up a selcall group for Radio Direct Dialling (secure telcalls) use the 'RDD' selcall type.





A selcall group for sending secure calls consists of:

- the self ID
- the called ID field left unset
- the selcall type set to 'RDD'
- the RDD PIN
- an optional comment describing the selcall group for RDD use.

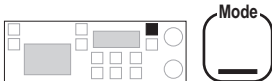
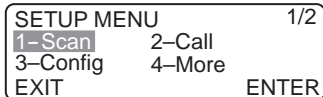
Setting up a selcall group

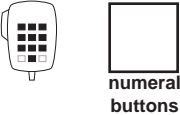
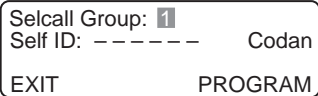
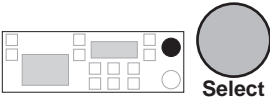
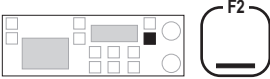
To set up a selcall group:

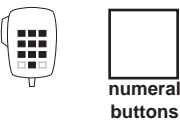
Action	Notes
<p>1. Repeatedly press</p>  <p>until you see the display for Setup mode.</p>	<p>The display shows:</p> 

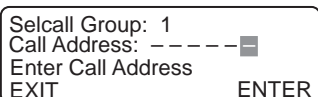
Action	Notes
<p>2. Enter 211</p> 	<p>Example of the display:</p> 
<p>3. To select the selcall group, rotate</p> 	<p>Select one of the five selcall groups 1–5.</p>
<p>4. Press</p> 	<p>Example of the display:</p> 
<p>5. Enter the self ID</p> 	<p>For an 'RDD' selcall type, enter the self ID for the network IPC-500 telephone interconnect.</p>
<p>6. Press</p> 	<p>Example of the display:</p> 

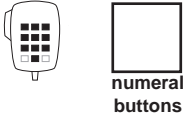
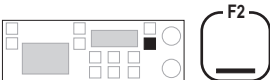
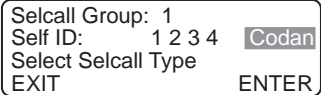
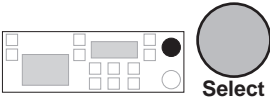
Action	Notes
<p>7. Enter the called ID</p> 	<p>Enter a called ID if you always want to call the same station on all channels programmed with this selcall group.</p> <p>To cancel an existing called ID, enter 0.</p> <p>If you leave the called ID unset, you will need to select the station when sending a call.</p>
<p>8. Press</p> 	<p>Example of the display:</p> 
<p>9. To select the selcall type, rotate</p> 	<p>Select:</p> <ul style="list-style-type: none"> • 'Codan' for normal selcalls • 'RDD' for secure RDD telcalls.

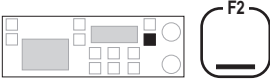
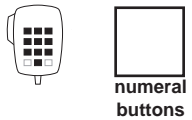
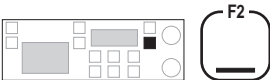
Action	Notes
<p>10. Press</p> 	<p>Example of the display for the 'Codan' selcall type:</p> <div style="border: 1px solid black; padding: 5px; width: fit-content;"> <pre>Selcall Group: 2 Self ID: 1 8 5 0 7 4 Codan █----- CLEAR ENTER</pre> </div> <p>Example of the display for the 'RDD' selcall type:</p> <div style="border: 1px solid black; padding: 5px; width: fit-content;"> <pre>Selcall Group: 1 PIN: ----- █ RDD Enter RDD PIN EXIT ENTER</pre> </div>
<p>11. Did you select the 'RDD' selcall type?</p> <p>Yes ➤ Step 12.</p> <p>No ➤ Step 14.</p>	
<p>12. Enter your RDD PIN</p> 	
<p>13. Press</p> 	<p>Example of the display:</p> <div style="border: 1px solid black; padding: 5px; width: fit-content;"> <pre>Selcall Group: 1 Self ID: 1 2 3 4 RDD █----- CLEAR ENTER</pre> </div>

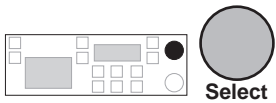
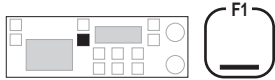
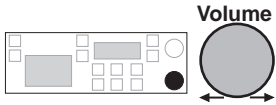
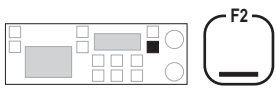
Action	Notes
<p>14. To enter a comment to describe this selcall group, rotate</p>	<p>Enter up to 20 characters. To clear any existing text, press</p>
 <p>The diagram shows a control panel with various buttons and a display. A large circular button labeled 'Select' is highlighted with a grey circle.</p>	 <p>The diagram shows a control panel with various buttons and a display. A button labeled 'F1' is highlighted with a grey circle.</p>
<p>to select each character and</p>	
 <p>The diagram shows a control panel with various buttons and a display. A large circular knob labeled 'Volume' is highlighted with a grey circle and has a double-headed arrow below it.</p>	
<p>to move along the line to the next character position.</p>	
<p>15. To save your changes for this selcall group, press</p>	<p>Example of the display:</p>
 <p>The diagram shows a control panel with various buttons and a display. A button labeled 'F2' is highlighted with a grey circle.</p>	<pre>Selcall Group: 1 Self ID: 1 2 3 4 RDD EXIT PROGRAM</pre>
	<p>or</p>
	<pre>Selcall Group: 2 Self ID: 1 2 3 4 Codan EXIT PROGRAM</pre>
<p>16. Do you want to set up another selcall group?</p>	
<p>Yes ➤ Return to Step 3.</p>	
<p>No ➤ Step 17.</p>	

Action

Notes

- 17.** To return to Channel mode, press four times



Example of the display:

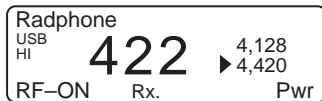

Selcall ID size compatibility (option)

Setup code 213

This procedure controls how you communicate with stations that can not use IDs longer than four digits.



Before you can use this procedure, you need to enable the selcall option (see Chapter 7, Password entry to enable transceiver options).

You can select:



- '4-DIGIT-COMPATIBLE'
- '6-DIGIT-ONLY'.

If some stations in your network are only capable of using 4-digit IDs and your self ID is longer than four digits, select '4-DIGIT-COMPATIBLE'. This allows other stations to call you using the last four digits of your self ID. For example, if your self ID is 123456, you can be called on ID 3456 as well as ID 123456—the transceiver will respond to both.

If all the stations in your network are capable of using 6-digit IDs, select '6-DIGIT-ONLY'. This ensures you can only be called by stations that specify your full self ID. You will not receive unwanted calls by chance matching of the last four digits of your self ID.

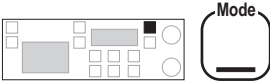
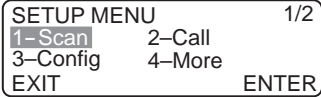
To set the operating compatibility for 4 or 6-digit selcall ID:

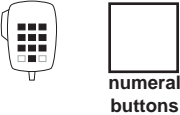
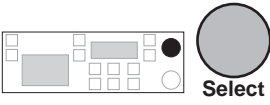
Action	Notes
<p>1. Repeatedly press</p>  <p>until you see the display for Setup mode.</p>	<p>The display shows:</p> 

Action	Notes
<p>2. Enter 213</p> 	<p>The display shows:</p> <div style="border: 1px solid black; padding: 5px; margin-bottom: 10px;"> <p>S'call Compatibility 4-DIGIT-COMPATIBLE 4-digit interoperable EXIT ENTER</p> </div> <p>or</p> <div style="border: 1px solid black; padding: 5px;"> <p>S'call Compatibility 6-DIGIT-ONLY Only 6-digit calls EXIT ENTER</p> </div>
<p>3. To switch between the two settings, rotate</p> 	<p>Select:</p> <ul style="list-style-type: none"> • '4-DIGIT-COMPATIBLE' if some stations in your network can not use 6-digit IDs • '6-DIGIT-ONLY' if all stations in your network are capable of using 6-digit IDs.
<p>4. To save your change, press</p> 	<p>The display shows:</p> <div style="border: 1px solid black; padding: 5px;"> <p>SELCALL MENU 1-ID 2-Mute 3-ID size EXIT ENTER</p> </div>

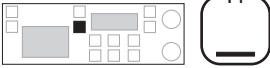
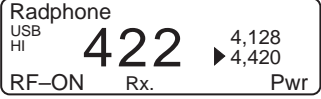
Action	Notes
<p>5. To return to Channel mode, press three times</p> 	<p>Example of the display:</p> 



Selcall lockout on/off (option)

Setup code 2441



This procedure switches selcall lockout on or off.

Before you can use this procedure, you need to enable the selcall and selcall lockout options (see Chapter 7, Password entry to enable transceiver options).

Selcall lockout prevents you from sending selective calls if the transceiver detects that another station is already in the process of sending a selective call on the same channel. This reduces call interference between stations and increases the chance of success when your call is transmitted.

Selcall lockout does not apply to voice, distress or tone calls.

To switch selcall lockout on or off:

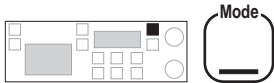
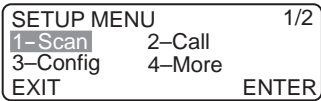
Action	Notes
1. Repeatedly press	The display shows:
	
until you see the display for Setup mode.	

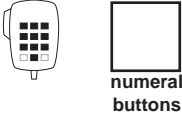
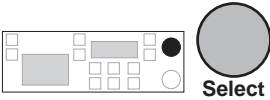
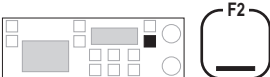
Action	Notes
<p data-bbox="239 220 460 244">2. Enter 2441</p> 	<p data-bbox="689 220 897 244">The display shows:</p> <div data-bbox="692 264 1012 363" style="border: 1px solid black; padding: 5px;"> <p>S'call Lockout Setup ENABLED Call lockout enabled EXIT ENTER</p> </div> <p data-bbox="689 392 714 411">or</p> <div data-bbox="692 429 1012 528" style="border: 1px solid black; padding: 5px;"> <p>S'call Lockout Setup DISABLED Call lockout disabled EXIT ENTER</p> </div>
<p data-bbox="239 603 566 691">3. To switch between 'ENABLED' and 'DISABLED', rotate</p> 	<p data-bbox="689 603 762 627">Select:</p> <ul data-bbox="689 655 1023 919" style="list-style-type: none"> • 'ENABLED' to prevent selcalls being made if another station has initiated a selcall on this channel. • 'DISABLED' to allow selcalls being made even if another station has initiated a selcall on this channel.
<p data-bbox="239 1091 570 1150">4. To save your change, press</p> 	<p data-bbox="689 1091 897 1118">The display shows:</p> <div data-bbox="692 1137 1012 1233" style="border: 1px solid black; padding: 5px;"> <p>CALL MENU 3/3 1-Lockout 2-Emgcy 3-Privacy 4-More EXIT ENTER</p> </div>

Action	Notes
5. To return to Channel mode, press twice	Example of the display: 



Selcall mute availability on/off (option)

Setup code 212

This procedure controls whether you can select selcall mute by pressing the **S'Call Mute** button on the control panel. Selecting selcall mute availability off, disables the selcall mute button.





Before you can use this procedure, you need to enable the selcall option (see Chapter 7, Password entry to enable transceiver options).

Switch selcall mute availability off if you never use selcalls. This will stop you selecting selcall mute by accident and missing incoming voice calls.

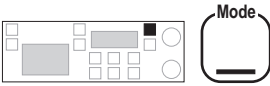
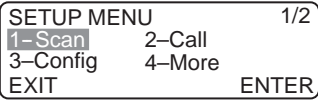
To switch the availability of selcall mute on or off:

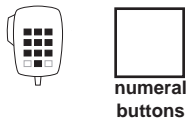
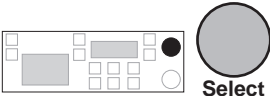
Action	Notes
<p>1. Repeatedly press</p>  <p>until you see the display for Setup mode.</p>	<p>The display shows:</p> 

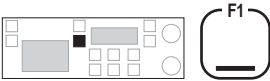
Action	Notes
<p>2. Enter 212</p> 	<p>The display shows:</p> <div style="border: 1px solid black; padding: 5px; margin-bottom: 10px;"> Selcall Mute ENABLED Selcall mute enabled EXIT ENTER </div> <p>or</p> <div style="border: 1px solid black; padding: 5px;"> Selcall Mute DISABLED Selcall mute disabled EXIT ENTER </div>
<p>3. To switch between 'ENABLED' and 'DISABLED', rotate</p> 	<p>Select:</p> <ul style="list-style-type: none"> • 'ENABLED' to make selcall mute available • 'DISABLED' to disable selcall mute control.
<p>4. To save your change, press</p> 	<p>The display shows:</p> <div style="border: 1px solid black; padding: 5px;"> SELCALL MENU 1-ID 2-Mute 3-ID size EXIT ENTER </div>
<p>5. To return to Channel mode, press three times</p> 	<p>Example of the display:</p> <div style="border: 1px solid black; padding: 5px;"> Radphone USB HI 422 ▶ 4,128 ▶ 4,420 RF-ON Rx. Pwr </div>



Telcall availability on/off (option)

Setup code 22





This procedure controls whether your transceiver can send telcalls.

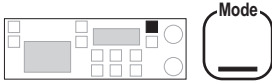

Before you can use this procedure, you need to enable the selcall option (see Chapter 7, Password entry to enable transceiver options).

For information on telcalls, refer to the *9390 User guide, Chapter 5, Telcall.*

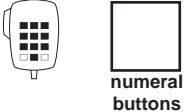
To switch the availability of telcalls on or off:

Action	Notes
<p>1. Repeatedly press</p>  <p>until you see the display for Setup mode.</p>	<p>The display shows:</p> 
<p>2. Enter 22</p> 	<p>The display shows:</p>  <p>or</p> 

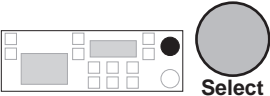
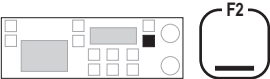
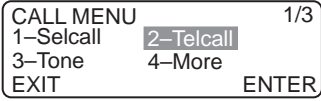
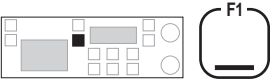
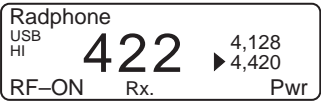
Action	Notes
<p>3. To switch between 'ENABLED' and 'DISABLED', rotate</p> 	<p>Select:</p> <ul style="list-style-type: none"> • 'ENABLED' to make telcalls available • 'DISABLED' to prevent telcalls being made.
<p>4. To save your change, press</p> 	<p>The display shows:</p> 
<p>5. To return to Channel mode, press twice</p> 	<p>Example of the display:</p> 



Tone call setup

Setup code 23

This procedure sets up the high and low frequency pairs for any of the four tone call groups T1–T4.

Having set up a tone call group, you can assign the group to any channel.

You can set frequencies in the range 300–2800Hz. If you want a tone call group to use a single frequency, set either the high or low frequency to 0Hz.

To set up a frequency pair for a tone call group:

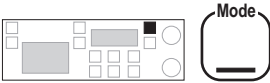
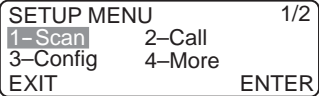
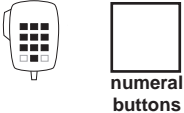
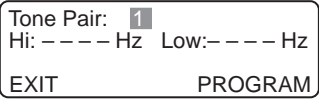
Action	Notes
<p>1. Repeatedly press</p>  <p>until you see the display for Setup mode.</p>	<p>The display shows:</p> 
<p>2. Enter 23</p> 	<p>Example of the display:</p> 

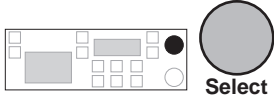
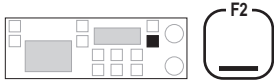
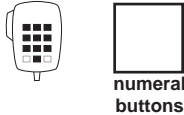
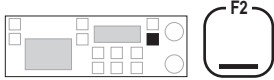
Action	Notes
<p>3. To select one of the four tone call groups, rotate</p> 	
<p>4. Press</p> 	<p>Example of the display for tone call group T3:</p> <div style="border: 1px solid black; padding: 5px;"> <p>Tone Pair: 3 Hi: --- Hz Low:--- Hz EXIT ENTER</p> </div>
<p>5. Enter the high frequency</p> 	<p>Set a frequency value in the range 300–2800Hz.</p> <p>This will cancel existing settings.</p>
<p>6. Press</p> 	<p>For example, a high frequency of 1400Hz looks like this:</p> <div style="border: 1px solid black; padding: 5px;"> <p>Tone Pair: 3 Hi: 1 4 0 0 Hz Low:--- Hz EXIT ENTER</p> </div>

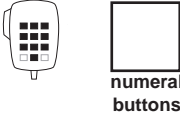
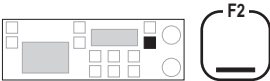
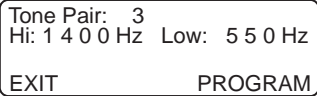
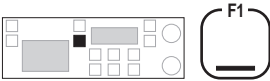
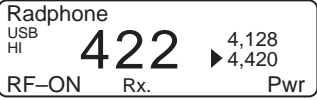
Action	Notes
<p>7. Enter the low frequency</p> 	<p>Set a value in the range 300–2800Hz.</p> <p>To cancel an existing setting and leave the low frequency unset, enter 0.</p> <p>Leave the low frequency unset if you want this tone call group to use a single frequency.</p>
<p>8. To save your changes, press</p> 	<p>For example, a low frequency of 550Hz looks like this:</p> 
<p>9. Do you want to set up another tone call group?</p> <p>Yes ➤ Return to Step 3.</p> <p>No ➤ Step 10.</p>	
<p>10. To return to Channel mode, press three times</p> 	<p>Example of the display:</p> 



99-beacon call response on/off (option)

Setup code 241



This procedure controls whether your transceiver can respond to a received 99-beacon call (selective call ending in 99).





The transceiver responds to a 99-beacon call by transmitting a beacon signal of four long tones.

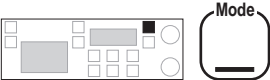
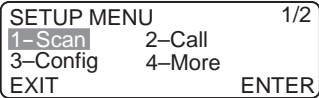
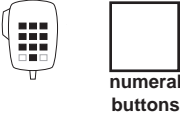

Before you can use this procedure, you need to enable the selcall option (see Chapter 7, Password entry to enable transceiver options).

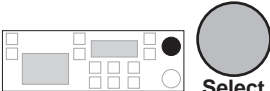
To switch the transceiver's response to 99-beacon calls on or off:

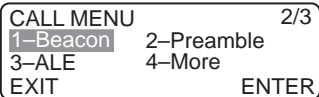
Action	Notes
<p>1. Repeatedly press</p>  <p>until you see the display for Setup mode.</p>	<p>The display shows:</p> 
<p>2. Enter 241</p> 	<p>The display shows:</p>  <p>or</p> 

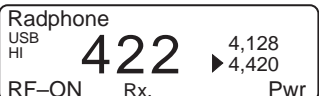
Action	Notes
<p>3. To switch between 'ENABLED' and 'DISABLED', rotate</p> 	<p>Select:</p> <ul style="list-style-type: none"> • 'ENABLED' to make your transceiver respond to received 99-beacon calls • 'DISABLED' to prevent your transceiver responding to received 99-beacon calls.
<p>4. To save your change, press</p> 	<p>The display shows:</p> 
<p>5. To return to Channel mode, press twice</p> 	<p>Example of the display:</p> 



9 Link Setup mode

Link Setup mode allows you to access transceiver options that affect transceiver operation and security.

This chapter describes the following Link Setup procedures:

- Link Setup mode enter/exit (9-2)
- Antenna band or channel control (9-5)
- PIN setup (9-7)
- Setup mode availability on/off (9-10)
- Transceiver reset to factory settings (9-12).

If you make a mistake and want to exit half way through a Link Setup procedure, press the **F1** button on the control panel or **PTT** button on the microphone. This will return you to the start of Link Setup mode without making any changes.

Link Setup mode enter/exit

To use Link Setup mode, you have to take off the bottom cover of the transceiver and position an internal link. When the link is fitted, the transceiver is muted and the **PTT** button is disabled.

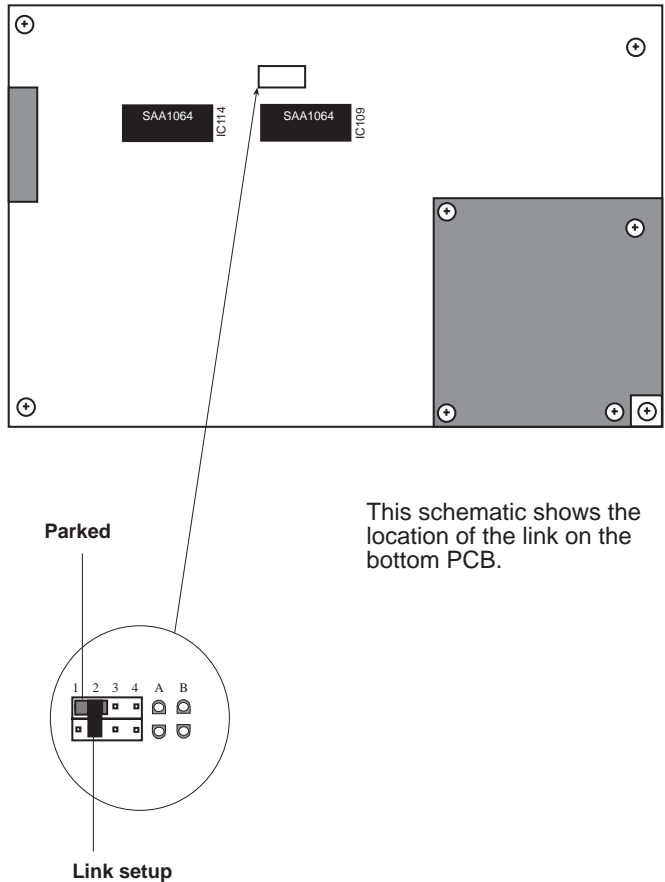

Figure 9.1 Moving the link for Link Setup mode

To use Link Setup mode:

Action	Notes
1. Ensure the transceiver is switched off.	
2. Remove the bottom cover by removing the screws on either side and lifting the cover off.	The bottom cover usually has four rubber feet fitted.
3. Locate the link shown in Figure 9.1 and move it to the Link setup position.	The link is a small connector that slides over two pins on the board. Pull it up gently to remove it.
4. Switch on the transceiver.	The display shows: <div data-bbox="693 898 1013 995" style="border: 1px solid black; padding: 5px; width: fit-content; margin: 10px auto;"> <pre>LINK SETUP MENU 1-Pin 2-Inhibit 3-Antenna 4-Reset ENTER</pre> </div> The transceiver only detects a changed link position when the transceiver is first switched on.
5. Follow one of the Link Setup procedures to make your changes.	See the Link Setup procedures later in this chapter. When all procedures have been completed continue with Step 6–8.

Action	Notes
6. Switch off the transceiver.	
7. Return the link to the original Parked position.	
8. Replace the bottom cover.	You are now ready to switch on the transceiver and continue normal operation.



Antenna band or channel control

This procedure controls the output of switching signals at the **Antenna Control** connector on the back panel of the transceiver.

You only need to use this procedure if you are using the transceiver to control equipment such as a multiple antenna installation or a switchable multi-frequency antenna. If you are using an automatic tuning antenna, any settings made by this procedure are ignored.

You can select:

- ‘CHANNEL’ if you want the transceiver to control equipment according to the single frequency of the selected channel
- ‘BAND’ if you want the transceiver to control equipment according to the operating frequency band of the supporting equipment (for example, add-on high power linear amplifiers).

For further details, contact your Codan agent.

To change the antenna control setting:

Action	Notes
1. Enter Link Setup mode.	<p>See <i>Link Setup mode enter/exit</i> on page 9-2.</p> <p>The display shows:</p> <div data-bbox="695 1203 1012 1299" style="border: 1px solid black; padding: 5px;"> <pre>LINK SETUP MENU 1-Pin 2-Inhibit 3-Antenna 4-Reset ENTER</pre> </div>

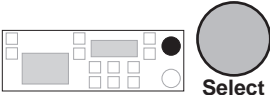
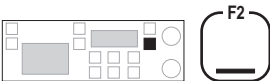
Action	Notes
<p>2. Enter 3</p> 	<p>The display shows:</p> <div data-bbox="638 263 957 359" style="border: 1px solid black; padding: 5px;"> <p>Antenna Control BAND EXIT ENTER</p> </div> <p>or</p> <div data-bbox="638 422 957 518" style="border: 1px solid black; padding: 5px;"> <p>Antenna Control CHANNEL EXIT ENTER</p> </div>
<p>3. To switch between 'BAND' and 'CHANNEL', rotate</p> 	<p>Select:</p> <ul style="list-style-type: none"> • 'BAND' if you want to control equipment by frequency band • 'CHANNEL' if you want to control equipment by channel frequency.
<p>4. Press</p> 	<p>The display shows:</p> <div data-bbox="638 973 957 1069" style="border: 1px solid black; padding: 5px;"> <p>LINK SETUP MENU 1-Pin 2-Inhibit 3-Antenna 4-Reset ENTER</p> </div>
<p>5. Exit Link Setup mode.</p>	<p>See <i>Link Setup mode enter/exit</i> on page 9-2.</p>



PIN setup

This procedure sets, changes or cancels the transceiver PIN.

Setting a PIN is a security feature. No one will be able to use the transceiver unless they know the programmed PIN.

You must know the current PIN to be able to change or cancel use of a PIN.







Do not forget your PIN!

If you do, you will be unable to use the transceiver. You will have to obtain a password from Codan to delete the PIN.

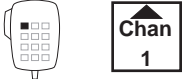
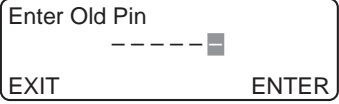
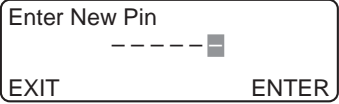
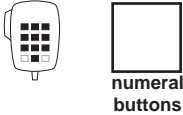
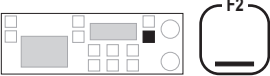
To set, change or cancel a PIN:

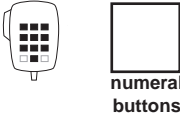
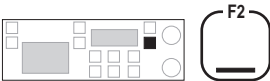
Action	Notes
1. Enter Link Setup mode.	See <i>Link Setup mode enter/exit</i> on page 9-2. The display shows:
	<div style="border: 1px solid black; padding: 5px; width: fit-content;"> <pre>LINK SETUP MENU 1-Pin 2-Inhibit 3-Antenna 4-Reset ENTER</pre> </div>

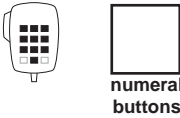
Action	Notes
<p>2. Enter 1</p> 	<p>If a PIN is currently set, the display shows:</p>  <p>If no PIN is currently set, the display shows:</p> 
<p>3. Is a PIN already set?</p> <p>Yes ➤ Step 4.</p> <p>No ➤ Step 6.</p>	
<p>4. Enter the current PIN</p> 	
<p>5. Press</p> 	<p>The transceiver ‘beeps’ twice and switches off if you enter the wrong PIN. Switch the transceiver on and repeat the procedure.</p>

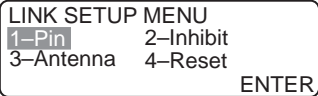
Action	Notes
<p>6. Enter the new PIN</p> 	<p>Enter up to 6 digits.</p> <p>To cancel the use of a PIN, enter 0.</p>
<p>7. Press</p> 	<p>The display shows:</p> 
<p>8. Enter the new PIN again</p> 	<p>The transceiver asks you to enter the PIN again to check that you are entering the right number.</p> <p>If the number is different the second time you enter it, the transceiver 'beeps'. Enter the new PIN again from Step 6.</p>
<p>9. Press</p> 	<p>The display shows:</p> 
<p>10. Exit Link Setup mode.</p>	<p>See <i>Link Setup mode enter/exit</i> on page 9-2.</p>



Setup mode availability on/off

This procedure switches the availability of Setup mode on or off.

After you have used Setup mode to set how the transceiver operates, denying casual access to Setup mode safeguards against accidental deletion or modification of programmed information.

For example, a transport manager controlling a fleet of ships might use this procedure to stop the transceivers installed in the ships from being modified once they have been set up.

To switch the availability of Setup mode on or off:

Action	Notes
<p>1. Enter Link Setup mode.</p>	<p>See <i>Link Setup mode enter/exit</i> on page 9-2.</p> <p>The display shows:</p> <div data-bbox="639 890 960 989" style="border: 1px solid black; padding: 5px;"> <pre>LINK SETUP MENU 1-Pin 2-Inhibit 3-Antenna 4-Reset ENTER</pre> </div>
<p>2. Enter 2</p> <div data-bbox="316 1114 378 1197" style="display: inline-block; vertical-align: middle;">  </div> <div data-bbox="426 1114 498 1189" style="display: inline-block; vertical-align: middle; border: 1px solid black; padding: 5px; margin-left: 20px;"> <p>F1 2</p> </div>	<p>The display shows:</p> <div data-bbox="639 1114 960 1209" style="border: 1px solid black; padding: 5px; margin-bottom: 10px;"> <pre>Setup Mode ENABLED Setup mode enabled EXIT ENTER</pre> </div> <p>or</p> <div data-bbox="639 1278 960 1374" style="border: 1px solid black; padding: 5px;"> <pre>Setup Mode DISABLED Setup mode disabled EXIT ENTER</pre> </div>

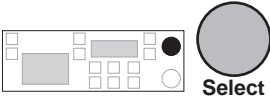
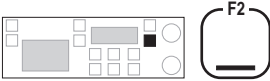
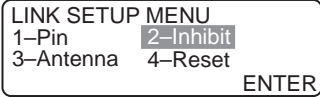
Action	Notes
<p>3. To switch between 'ENABLED' and 'DISABLED', rotate</p> 	<p>Select:</p> <ul style="list-style-type: none"> • 'ENABLED' to allow use of Setup mode • 'DISABLED' to prevent use of Setup mode.
<p>4. Press</p> 	<p>The display shows:</p> 
<p>5. Exit Link Setup mode.</p>	<p>See <i>Link Setup mode enter/exit</i> on page 9-2.</p>



Transceiver reset to factory settings

This procedure resets the transceiver to factory settings.

You can:

- delete all unprotected channels
- reset user settings to the factory default values
- reset user settings to the factory default values and delete all channels except for the factory set Radphone channels.







Think carefully before using this procedure! It can delete all protected channels set up by Codan (except for Radphone channels) listed in the Marine Frequency List supplied with the transceiver.

User settings include all settings in the transceiver except for:

- channel information
- PIN
- transceiver options installed by Codan or enabled by password
- display brightness and contrast settings.

To reset some or all of the transceiver settings to their factory values:

Action	Notes
1. Enter Link Setup mode.	See <i>Link Setup mode enter/exit</i> on page 9-2. The display shows: <div data-bbox="693 467 1012 563" style="border: 1px solid black; padding: 5px;"> LINK SETUP MENU 1-Pin 2-Inhibit 3-Antenna 4-Reset ENTER </div>
2. Enter 4	The display shows: <div data-bbox="693 684 1012 780" style="border: 1px solid black; padding: 5px;"> Press F2 to: Delete all unprotected channels EXIT RESET </div>
3. To switch between the three types of reset, rotate	<div data-bbox="342 691 549 770" style="display: flex; align-items: center; gap: 10px;">  <div style="border: 1px solid black; padding: 5px; text-align: center;">4 Chan ▼</div> </div> <div data-bbox="342 943 613 1038" style="display: flex; align-items: center; gap: 10px;">  <div style="border: 1px solid black; border-radius: 50%; width: 40px; height: 40px; display: flex; align-items: center; justify-content: center;">  </div> <div style="margin-left: 5px;">Select</div> </div> <div data-bbox="689 863 1023 1321"> Select: <ul style="list-style-type: none"> • ‘Delete all unprotected channels’ to delete just unprotected channels • ‘Reset user settings to factory defaults’ to reset user settings but not channels • ‘Reset user settings, delete all channels’ to reset user settings and all channels except factory set Radphone channels. </div> <div data-bbox="732 1337 1003 1404" style="text-align: center;">  <i>Use with caution!</i> </div>

Action

Notes

4.

Press

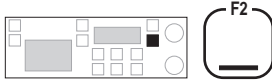

The display looks like one of the following:

Press F2 to confirm:
Delete all unprotected channels
EXIT RESET

Press F2 to confirm:
Reset user settings to factory defaults
EXIT RESET

Press F2 to confirm:
Reset user settings, delete all channels
EXIT RESET

To exit this procedure without resetting anything, press

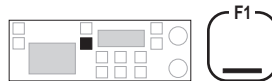

5.

To start the reset, press

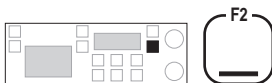

The display shows:

LINK SETUP MENU
1-Pin 2-Inhibit
3-Antenna 4-Reset
ENTER

6.

Exit Link Setup mode.

See *Link Setup mode enter/exit* on page 9-2.



10 Display messages

This chapter lists all messages that are shown on the transceiver display. These include:

- transceiver status messages
- operator error messages
- system error messages.

Some error messages are accompanied by one or more ‘beeps’.

Message	Meaning	Action
ALE ACK timeout	The transceiver cannot communicate with the 9300 ALE controller.	If the 9300 ALE controller is connected, check the cables between the ALE and transceiver. If no ALE is connected, see <i>Chapter 7, RS-232 connected equipment</i> to remove ALE from the setup. If you need help, contact your Codan agent.
ALE not initialised	The 9300 ALE controller has not been initialised.	To initialise the ALE controller, switch it off and then on again. If no ALE controller is connected, see <i>Chapter 7, RS-232 connected equipment</i> to remove ALE from the setup.
Antenna untuned	The auto tuner or antenna is not tuned.	Press the Tune button to tune the antenna.
Auto-tuning	The antenna is automatically being tuned prior to a selcall, selective beacon call or page call being sent.	None.
Bad ALE ACK	The transceiver cannot communicate with the 9300 ALE controller.	If the 9300 ALE controller is connected, check the cables between the ALE and transceiver. If no ALE is connected, see <i>Chapter 7, RS-232 connected equipment</i> to remove ALE from the setup. If you need help, contact your Codan agent.
Bad ALE SCall channel	A channel in the ALE scan table has not been assigned to a selcall group.	Assign a selcall group (S1–S5) to this ALE selcall channel. See <i>Chapter 8, Selcall ID setup</i> .

Message	Meaning	Action
Bad record type XX	Data was corrupted during XP programming.	Check the XP cables. Switch the transceiver off and then on again. If the problem remains, contact your Codan agent for help.
Bad type/inst XX/XX	The transceiver detected an internal data fault.	Switch the transceiver off and then on again. If the problem remains, contact your Codan agent for help.
BBRAM Ck/Sum Err	Data in the battery backup RAM has become corrupted.	Contact your Codan agent for help.
BBRAM update failed	The transceiver cannot read/write data to the battery backup RAM.	Contact your Codan agent for help.
Call stack empty	There are no selcall, telcall or page calls stored in the call memory.	Refer to the <i>9390 User guide</i> , <i>Chapter 6, Reviewing and returning calls held in memory.</i>
Channel not found	This channel number is not used.	Select a channel that exists.
Channel protected	The selected channel is protected against change or deletion.	Contact your Codan agent if you need to delete or change this channel.
Channel space full	The maximum number of channels have been set up.	If you want to add channels, first delete unwanted channels that are not protected (NP). See <i>Chapter 3, Deleting a channel.</i> For protected channels (P), contact your Codan agent for help.

Display messages

Message	Meaning	Action
Channel used	This channel already exists and you are about to change its channel settings.	Continue unless you do not want to change this channel. See <i>Chapter 3, Customising channels</i> .
Clarifier	Clarifier mode has been selected.	Clarify by using the Select knob on the control panel. Refer to the <i>9390 User guide, Chapter 4, Using Clarifier mode</i> .
Cloning failed	Cloning the transceiver has failed.	Check the programming cables. Switch the transceiver off and then on again. Try cloning again. If the problem remains, contact your Codan agent for help.
Cloning finished	Cloning has completed successfully.	None.
Completed	The transceiver has finished loading information from the 9300 ALE controller.	None.
Data	The transceiver is in Data mode.	None.
Disconnect Err	The transceiver received a 'disconnect call' when it was not operating with an IPC-500.	If the problem remains, contact your Codan agent for help.
Empty scan table	No channels have been set up in the selected scan table.	To set up a scan table, see <i>Chapter 3, Creating a scan table</i> .
Error PIN mismatch	You entered a different number the second time you entered your new PIN.	Set up the PIN again. See <i>Chapter 9, PIN setup</i> .

Message	Meaning	Action
Error: no self ID	No selcall self ID has been set up.	See <i>Chapter 8, Selcall ID setup</i> .
External RAM bad	The transceiver cannot read/write to parallel RAM on power up.	Switch the transceiver off and then on again. If the problem remains, contact your Codan agent for help.
Frequency not found	No channel has been set up for this frequency.	If you want to receive on this frequency, see <i>Chapter 3, Creating a receive-only channel</i> . If you want to send on this frequency, contact your Codan agent.
FSK calibration fail	The selcall decoder is not calibrated.	Switch the transceiver off and then on again. If the message reappears, contact your Codan agent for help.
I2C bus error XXXX:XXXX	There is a major hardware fault on one of the I ² C bus lines.	Contact your Codan agent for help.
Intrnl Tmr Alloc Err	The transceiver detected an internal timer allocation error.	Switch the transceiver off and then on again. If the problem remains, contact your Codan agent for help.
Invalid IPC channel	This channel is not available for IPC-500 use.	Contact your Codan agent for help.
Link established	The transceiver has set up an ALE link with the other station.	Proceed with your call. For details on ALE, see <i>Chapter 5, ALE option settings</i> .
Link failed	The transceiver failed to set up an ALE link. The call has failed.	Try sending another ALE call. For details on ALE, see <i>Chapter 5, ALE option settings</i> . Contact your Codan agent if you need help.

Display messages

Message	Meaning	Action
Loading ALE data	The transceiver is loading information from the 9300 ALE controller.	Wait for loading to finish.
Low battery	The battery voltage has dropped below 10 volts.	Recharge or change the battery.
No ALE scan table	No channels have been set up in the ALE scan table.	To set up an ALE scan table, see <i>Chapter 3, Creating a scan table</i> (set scan type 'ALE').
No calls available	Either selective calling has not been enabled or no selcall group is assigned to this channel.	See <i>Chapter 7, Password entry to enable transceiver options</i> . For changing channel settings, see <i>Chapter 3, Changing channel options</i> . Select one of the selcall groups S1–S5. If the channel is protected, contact your Codan agent for help.
No channels fitted	No channels have been set up in the transceiver.	Contact your Codan agent for help.
No deflt rec for XX	The transceiver could not read a default record.	Switch the transceiver off and then on again. If the problem remains, contact your Codan agent for help.
No destination ID	No selcall called ID has been set up.	Refer to the <i>9390 User guide, Chapter 5, Selcall</i> for how you enter the selcall ID of the station you want to call.

Message	Meaning	Action
No GPS information	No data was received from the GPS receiver.	If no GPS receiver is connected, switch off GPS error 'beeping' (see <i>Chapter 6, GPS timeout on/off</i>). If a GPS receiver is plugged into the RS232 socket, make sure that the RS-232 setting is set to 'GPS NMEA-0183' (see <i>Chapter 7, RS-232 connected equipment</i>). Check cables.
No real time clock	The clock is faulty.	Contact your Codan agent for help.
No response	There was no response from the destination station after sending a page call.	Find the best signal path to use by sending selective beacon calls on available channels. Send the page call again. If there is still no response, check that the privacy number is set correctly (see <i>Chapter 5, Call privacy on/off</i>).
No selcall send	This channel does not allow you to send selcalls.	Contact your Codan agent for help.
No tones programmed	No tone call frequencies have been set up.	See <i>Chapter 8, Tone call setup</i> .
Not enabled	This option is switched off.	To switch the option on, refer to the relevant procedure in this book.
Not tuned	The antenna has not been tuned.	Press the Tune button to tune the antenna.
Option not fitted	This option has not been enabled in the transceiver.	If you want this option, contact your Codan agent.
Page call succeeded	A page call was acknowledged.	None.

Message	Meaning	Action
Parallel EEPROM bad	Data in the parallel E ² PROM has become corrupted.	Contact your Codan agent for help.
Program inhibited	The selected channel is protected from deletion.	If you want to copy this channel to another channel number, see <i>Chapter 3, Copying a channel to a new channel number</i> . If you need help, contact your Codan agent.
PTT cutout	Transmission time has exceeded the set limit.	If you want to change the time limit, see <i>Chapter 7, PTT transmit cutout</i> .
PTT inhibited	The selected channel is a receive-only channel.	Select another channel if you want to transmit.
Queue full	The internal task queue is full.	Switch the transceiver off and then on again. If the problem remains, contact your Codan agent for help.
RAM fault	The transceiver cannot read data from the parallel RAM.	Contact your Codan agent for help.
RTC Ck/Sum Err	The transceiver detected a real time clock checksum error.	Switch the transceiver off and then on again. Check the clock's lithium backup battery. If the problem remains, contact your Codan agent for help.
S'call mute disabled	Selcall mute availability is switched off.	To make selcall mute available, see <i>Chapter 8, Selcall mute availability on/off</i> .

Message	Meaning	Action
Scan abort	Scanning has stopped because the PTT or another button was pressed.	To exit Scan mode, refer to the <i>9390 User guide, Chapter 4, Scanning for incoming calls.</i>
Scan inhibited	Scan table editing is not currently allowed.	To allow scan tables to be edited, see <i>Chapter 8, Scan table editing on/off.</i>
Scan program full	This scan table is full because it contains the maximum number of 10 channels.	See <i>Chapter 3, Creating a scan table.</i>
Scan-tuning	The antenna is automatically being tuned now that Scan mode has been initialised.	None.
SEEPROM Ck/Sum Err	Data in the serial E ² PROM has become corrupted.	Contact your Codan agent for help.
Serial BBPROM bad	The transceiver cannot read/write reliably to the battery backup ROM on power up.	Contact your Codan agent for help.
Serial EEPROM bad	The transceiver cannot read/write reliably to the serial E ² PROM on power up.	Contact your Codan agent for help.
Serial EEPROM fail XX	The transceiver detected an error in reading/writing data to the serial E ² PROM.	Contact your Codan agent for help.
Telcall disabled	Making telcalls from the transceiver is not currently allowed.	To switch the availability of telcalls on, see <i>Chapter 8, Telcall availability on/off.</i>

Message	Meaning	Action
Tone is disabled	You cannot send a tone call because no tone call group has been assigned to this channel.	To assign a tone call group to this channel, see <i>Chapter 3, Changing channel options</i> .
Transmit inhibited	The selected channel is a receive-only channel.	Select a channel enabled for transmission.
Tune abort	Antenna tuning has been cancelled because the PTT button on the microphone has been pressed.	If necessary, tune the antenna again.
Tune fail	Antenna tuning failed.	Check the position of the antenna (for example, too close to buildings), then press the Tune button to tune the antenna again.
Tune pass	The antenna was successfully tuned.	None.
Tuner fault	The transceiver failed to tune the antenna within two minutes.	Check the installation (for example, cables to the antenna tuner), then press the Tune button to tune the antenna again. If the problem remains, contact your Codan agent for help.
Tuning	The Tune button was pressed and the antenna is now being tuned.	None.
Unknown error: XX	The transceiver detected an unknown data error.	Contact your Codan agent for help.
Unlock error VC01	VC01 is unlocked.	Contact your Codan agent for help.
Unlock error VC01&2	VC01 and VC02 are unlocked.	Contact your Codan agent for help.

Message	Meaning	Action
Unlock error VC02	VC02 is unlocked.	Contact your Codan agent for help.
Value too high	The entered number is too large.	Enter the correct number.
Value too low	The entered number is too small.	Enter the correct number.
Writing SEE defaults	Now reprogramming serial E ² PROM with default settings.	None.
Out of PA range	A channel has a frequency outside the PA operating frequency band.	Contact your Codan agent for help.



Display messages

11 Appendix



This chapter:

- describes the pin arrangements of connectors on the transceiver and control head (11-2)
- lists the ancillary equipment you can connect to the transceiver (11-8)
- explains how to use the optional RS-232/I²C Interface to connect combinations of ancillary equipment (11-10)
- lists the transceiver specifications (11-14)
- lists the transceiver options available (11-15)
- lists the accessories available for the transceiver (11-16).

Connectors

Only suitably qualified personnel should use the information contained in this section. Failure to observe the stated and implied criteria could result in damage to the transceiver.

This section covers:

- the microphone socket
- the **Antenna Control** connector
- the **Remote Control** connector
- the **GP** connector
- the **RS232** socket
- the loudspeaker **L/S** socket
- the **Ext Alarm** socket.

Microphone socket

The microphone socket is unmarked. It is located at the left of the front panel.

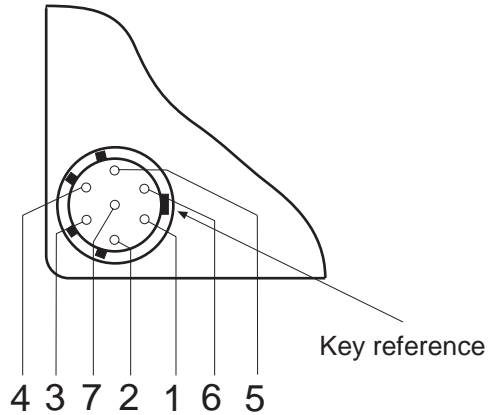

Pin	Function
1	Loudspeaker audio output
2	Microphone input
3	Ground
4	Data in
5	PTT in (active low) and data out
6	Battery (switched)
7	Front panel speaker (ground return)

Antenna Control connector

The **Antenna Control** connector is located at the left of the back panel.

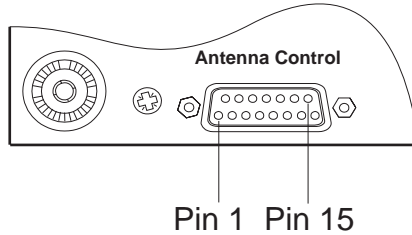

Pin	Function
1	Binary coded decimal channel 4
2	Binary coded decimal channel 8
3	Not used
4	Tune in and out (active low)
5	Scan antenna (active low)
6	Not used
7	Not used
8	PTT out (+10V=Tx)
9	Binary coded decimal channel 1
10	Binary coded decimal channel 2
11	Tuned in
12	Battery (switched)
13	Battery (switched)
14	Ground
15	Ground

Remote Control connector

The **Remote Control** connector is located at the right of the back panel.



*Make sure that the transceiver is disconnected from the DC power source before connecting anything to the **Remote Control** connector.*

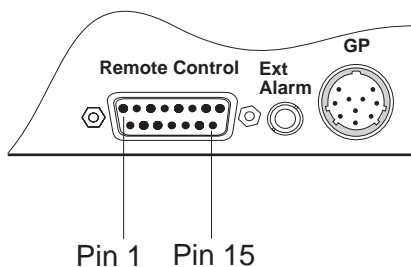

Pin	Function
1	Speaker
2	Remote PTT
3	External audio input
4	Power on
5	Data (I ² C bus, 5V)
6	Not used
7	Clock (I ² C bus, 5V)
8	Rx and Tx indicator
9	Ground
10	Ground
11	Transmitter audio input
12	Receiver demodulated output
13	Receiver audio output
14	Interrupt (I ² C bus, 5V)
15	Battery (switched)

GP connector

The 10-pin **GP** connector is located at the right of the back panel. It is used for ALE controllers, modems and fax interfaces.

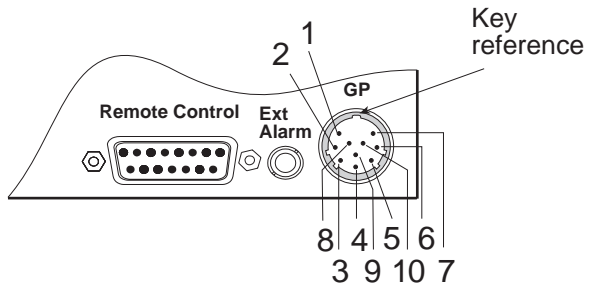

Pin	Function
1	Ground
2	Receiver output
3	Transmitter input
4	Quiet line
5	Alarm input
6	PTT input (active low)
7	Scan
8	Battery (switched)
9	RS-232 receive
10	RS-232 transmit

RS-232 socket

The RS-232 socket is labelled **RS232**. It is located at the middle of the back panel.

Connection	Function
Tip	Data input to transceiver
Ring	Data output from transceiver
Sleeve	Ground

Loudspeaker socket

The Loudspeaker socket is labelled **L/S**. It is located at the middle of the back panel.

Connection	Function
Tip	Speaker audio output
Sleeve	Ground

External alarm socket

The external alarm socket is labelled **Ext Alarm**. It is located at the right of the back panel.

Connection	Function
Tip	Relay switch contact
Sleeve	Relay switch contact (ground)



Connecting ancillary equipment

The following ancillary equipment plugs into the rear panel of the transceiver:

- 8571 Remote control interface
- 9300 ALE controller
- 9366 control head
- automatic antenna and antenna tuner
- computer
- data and fax modem
- external alarm
- GPS receiver
- IPC-500 telephone interconnect.

The following table shows the connections on the transceiver rear panel for ancillary equipment.

Equipment connected to either the **RS232** socket or **GP** connector on the transceiver rear panel is controlled by the transceiver's RS-232 and baud rate settings. See *Chapter 7, RS-232 connected equipment* and *RS-232 connection baud rate*.

If you want to connect a combination of ALE controllers, modems, GPS receivers and computers, you will need to use the optional RS-232/I²C Interface described on page 11-10.

Ancillary equipment	Transceiver rear panel connection	Notes
8571 Remote control interface	Remote Control connector	
9300 ALE controller	GP connector	Set RS-232 setting to '9300 ALE' and baud rate to '9600'.
9366 control head	Remote Control connector	
Automatic antenna and antenna tuners	Antenna Control connector	
Computer	RS232 socket	Set RS-232 setting to 'COMPUTER' and baud rate to the value used by the computer (typically '9600').
Data and fax modems	GP connector	
Extension loudspeaker	L/S socket	
External alarm	Ext Alarm socket	
GPS receiver	RS232 socket	Set RS-232 setting to 'GPS NMEA-0183' and baud rate to the value used by the GPS receiver (typically '4800').
IPC-500 telephone interconnect	Remote Control connector	



Using the optional RS-232/I²C Interface

The RS-232/I²C Interface is an adaptor that plugs into the **Remote Control** connector. It provides two additional sockets for connecting a GPS receiver and computer.

You need to use this interface when connecting any combination of ALE controllers, modems, GPS receivers and computers as the transceiver can only support one RS-232 port.

The interface has:

- a **GPS** socket for a GPS receiver
- a **COMPUTER** socket for a computer
- a **Remote Control** connector for remote control equipment or a control head.

Internal switches control the equipment connections:

- the **GPS** switch controls use of the **GPS** socket
- the **COMP** switch controls use of the **COMPUTER** socket
- the **I²C** switch is only used if a second interface is connected
- the **GPS A** and **GPS B** switches set the baud rate for **GPS** socket
- the **COMP A** and **COMP B** switches set the baud rate for the **COMPUTER** socket.

Setting up the RS-232/I²C Interface

If you need assistance in setting up the interface, contact your Codan agent.

The internal switches are labelled on the inside of the cover to the interface as follows:

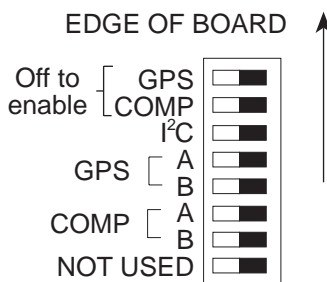

Switches may only mark the **On** or **Off** position.

The table below shows the possible baud rate settings for either pair of **GPS A/B** and **COMP A/B** switches:

GPS A or COMP A switch	GPS B or COMP B switch	Setting
on	on	9600 baud (no parity, 1 stop bit)
off	on	4800 baud (no parity, 1 stop bit)
on	off	2400 baud (no parity, 1 stop bit)
off	off	1200 baud (no parity, 1 stop bit)

To set up the interface:

Action	Notes
1. Remove the single screw securing the back cover of the interface and remove the cover.	
2. Do you want to use the GPS socket? Yes ➤ Step 3. No ➤ Step 5.	If you are not using this socket, make sure that the GPS switch is set to the on position (only the On or Off position may be marked).
3. Set the GPS switch to the off position.	The off position enables the socket.
4. Use the GPS A and GPS B switches to set the baud rate for the GPS receiver.	Refer to the table above. The most common setting is 4800 baud.
5. Do you want to use the COMPUTER socket ? Yes ➤ Step 6. No ➤ Step 8.	If you are not using this socket, make sure that the COMP switch is set to the on position (only the On or Off position may be marked).
6. Set the COMP switch to the off position.	The off position enables the socket.

Action	Notes
7. Use the COMP A and COMP B switches to set the baud rate for the computer.	Refer to the table above. The most common setting is 9600 baud.
8. Replace the cover and secure it with the screw.	

If you want to connect more ancillary equipment such as an additional computer, plug a second interface into the **Remote Control** connector of the first interface.

Make sure that the **I²C** switches are not set to the same position for both units. Set one to the on position and the other to the off position.



Specifications

Frequency range	Transmit: 2 to 26.5MHz Receive: 250kHz to 30MHz
Channel capacity	Up to 600 channels
Operating mode	Single sideband (J3E; USB–LSB)
Transmitted power output	125 watts (PEP)
Supply voltage	12V DC nominal, negative earth Normal operating range 10.5V to 15V DC Maximum operating range 9V to 16V DC Reverse polarity protection is provided.
Overvoltage protection	Shutdown at 16V DC (nominal) for duration of overvoltage
Supply current	Receive (no signal): 0.75A Transmit J3E voice: 6A (average) J3E two tone: 9–12A
Size and weight	9390 transceiver (excluding cradle) Dimensions: 250mm W x 320mm D x 78mm H Weight: 3.3kg 9391 control head (including cradle) Dimensions: 250mm W x 70mm D x 90mm H Weight: 0.9kg



Transceiver options

The options available for the 9390 transceiver are listed below.

Some options require physical modifications to your transceiver.

Code	Options
ALE	Enable Automatic Link Establishment
F	Fan for continuous data transmission
GPS	Enable Global Positioning System (GPS) capability
M	Morse facility (replaces selective call Ext Alarm connector)
PH	Headphone socket
STE	Enable selective calling (beacon, selcall, telcall and page)
TXE	Enable user programming of transmit frequency (where permitted by local licensing authorities)



Accessories

The following accessories are available for the 9390 transceiver:

Code	Accessories
121	2-module clamp suitable for locking 9390 with another item of equipment having the same physical design
122	3-module clamp suitable for locking 9390 with two other items of equipment having the same physical design
157	E-plate (radio earth plate) for fibreglass or wooden vessels
649	Extension loudspeaker
705	Copper earth strip 50 mm x 0.46 mm (26 gauge) for connecting transceiver to E-plate
711	Bulkhead mounting fuse holder for transceiver DC power cable—supplied with 32 amp fuse
712	32 amp fuse for code 711
733	Aerial DC isolator
752	RS-232/ I^2C Interface unit to provide two additional RS-232 facilities for GPS and computer.
2037	Service manual for 400 watt PA type 4404
2051	Service manual for type 9390 series
9391	Control head complete with hand PTT/key-pad control microphone and 6 metres of interface cable fitted with connectors



	—9—		
99-beacon call			
response on/off	8-26		
	—A—		
accessories	11-16		
ALE			
connecting the unit	11-8		
connection settings	11-10		
option	7-2		
reset	5-9		
scanning	3-24, 8-2		
settings	5-2		
sounding interval	5-11		
AM option	7-2		
ancillary equipment	2-16		
connecting the units	11-8		
connection settings	11-10		
antenna			
band or channel control	9-5		
connector	11-4		
setup	2-16		
automatic link establishment	<i>See</i> ALE		
	—B—		
battery power supply	2-10		
beep loudness	5-13		
	—C—		
call			
lockout	8-16		
preamble length	5-15		
privacy on/off	5-17		
changing			
		channel comment	3-6
		channel options	3-8
		receive frequency	3-11
		transmit frequency	3-21
		channel	
		changing receive frequency	3-11
		comment	3-6
		copying	3-4
		creating and editing	3-2
		creating in Free-Tune Receiver	3-16
		creating receive-only	3-13
		deleting	3-19
		options	3-2, 3-8
		protected	3-3
		Radphone	3-3
		recall by frequency	7-20
		settings	3-2
		standard marine	3-3
		transmit frequency	3-21
		type	3-2
		clock	
		calibration	5-19
		setting	5-21
		clone a transceiver	5-26
		coast station	2-2
		computer	
		connecting the unit	11-8
		connection settings	11-10
		connecting ancillary equipment	11-8
		connection settings	11-8, 11-10
		connectors	11-2
		antenna control	11-4
		external alarm	11-7
		GP	7-18, 7-24, 7-27, 11-6
		loudspeaker	11-7
		microphone	11-3
		remote control	11-5
		RS-232	7-24, 7-27, 11-7
		control head	

Index

grounding 2-12
installing 2-7
copying a channel 3-4
creating
 channels 3-2
 receive-only channel 3-13, 3-16
 scan table 3-24
 telephone directory 3-31
 transmit channel 3-21

—D—

deleting
 channel 3-19
 PIN 7-6
 scan table 3-29
display
 brightness 6-2
 contrast 6-4
 frequency 6-6
 messages 10-1

—E—

earthing 2-12
editing
 channel 3-2
 scan table 3-24
 telephone directory 3-31
enabling transceiver option 7-2
error messages 10-1
external alarm connector 11-7

—F—

fault finding error messages 10-1
Free-Tune Receiver mode
 availability on/off 6-9
 creating receive-only channel 3-16
fuses 11-16

—G—

global positioning system *See* GPS
glossary 1-4
GP connector 7-18, 7-24, 7-27, 11-6

GPS
 connecting the unit 11-8
 connection settings 11-10
 display on/off 6-11
 option 7-3
 timeout on/off 6-13
grounding 2-12

—I—

ID
 display on power up 7-14
 setup 8-6
 size compatibility 8-13
installing
 control head 2-7
 transceiver 2-5

—L—

LCD *See* display
Link Setup mode
 antenna band or channel control 9-5
 enter/exit 9-2
 PIN setup 9-7
 Setup mode availability on/off 9-10
 transceiver reset 9-12
lockout 8-16
loudspeaker connector 11-7

—M—

marine channels 3-3
messages
 full list 10-1
 on power up 7-8
microphone connector 11-3
mounting
 control head 2-7
 transceiver 2-5
mute
 during scanning 3-24
 on power up 7-11
 selcall 8-19

—O—

operating the transceiver *See user guide*
 options
 ALE 7-2
 AM 7-2
 enabling 7-2
 GPS 7-3
 list of 7-2, 11-15
 of a channel 3-8
 Selcall 7-3
 Selcall Lockout 7-3
 TXE 3-3, 3-21

—P—

password
 deleting PIN 7-6
 enabling transceiver option 7-2
 personal identification number *See* PIN
 PIN
 deleting 7-6
 setup 9-7
 power supply 2-10
 power up
 message on/off 7-8
 mute setting 7-11
 selcall self ID display on/off 7-14
 protected channel 3-3
 PTT
 release beep on/off 7-16
 transmit cutout 7-18

—R—

Radio Direct Dial 8-7
 Radphone 3-3
 RDD 8-7
 rear panel connectors 11-2
 recall channels by frequency on/off 7-20
 receive frequency 3-2
 remote control connector 11-5
 RF gain on/off 7-22
 RS-232
 connected equipment 7-24
 connection baud rate 7-27

socket 7-24, 7-27, 11-7
 RS-232/I²C Interface 11-10

—S—

scan table
 automatic scanning start 8-2
 creating 3-24
 deleting 3-29
 editing on/off 8-4
 types of 3-24
 selcall
 group 8-6
 ID setup 8-6
 ID size compatibility 8-13
 lockout on/off 8-16
 lockout option 7-3
 mute availability on/off 8-19
 selective calling 1-5
 option 7-3
 Setup mode
 advanced users 4-7
 availability on/off 9-10
 list of procedures 4-3
 tree 4-8
 using 4-1
 ship station 2-3
 sockets *See* connectors
 specifications 11-14
 station
 coast 2-2
 ship 2-3

—T—

telcall availability on/off 8-21
 telephone directory creation 3-31
 tone call setup 8-23
 transceiver
 accessories 11-16
 grounding 2-12
 installing 2-5
 options 7-2, 11-15
 reset 9-12
 using *See user guide*
 transmit frequency 3-2

Index

troubleshooting messages 10-1
TXE option 3-3, 3-21

using the transceiver

—U—

See user guide