

MF/HF

MF/HF Radiotelephone

Models: FS-I 575/2575/5075

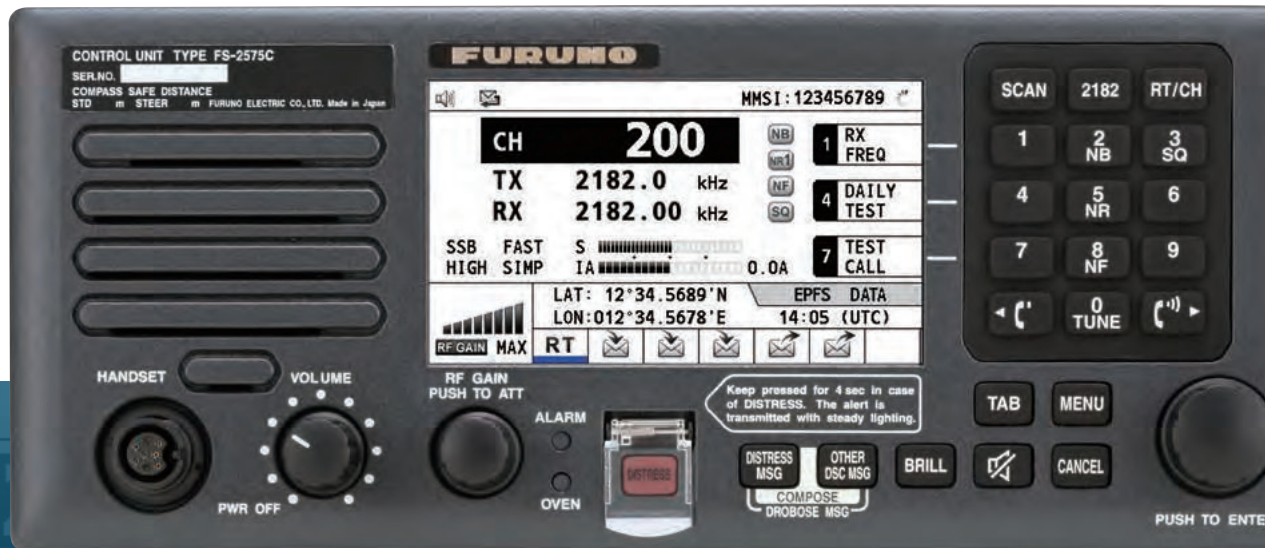



Reliable MF/HF Radiotelephone for general and distress communications with integrated DSC/DSC Watch Receiver



**Models: FS-1575 (150 W)
FS-2575 (250 W)
FS-5075 (500 W)**

- ▶ **MF/HF radiotelephone with DSC facility**
- ▶ **Fully meets GMDSS carriage requirements for SOLAS ships operating in A2, A3 and A4 sea areas**
- ▶ **Meets the new ITU recommendation on digital selective calling system for use in the Maritime Mobile Service, ITU-R M.493-14**
- ▶ **High-contrast 4.3" bright color LCD (480x272 pixels)**
- ▶ **Capable of distress, safety and routine communication**
- ▶ **Instant selection of 256 user-specified channels with a rotary knob or direct keypad input**
- ▶ **Quick access to DSC message composition by dedicated keys on the control unit**
- ▶ **Full-duplex kit available (optional supply for the FS-5075 only)**
- ▶ **Quick access to dedicated functions in the menu operation using numeric keypad**

High-contrast 4.3" bright color LCD

Display Modes

Radiotelephone display

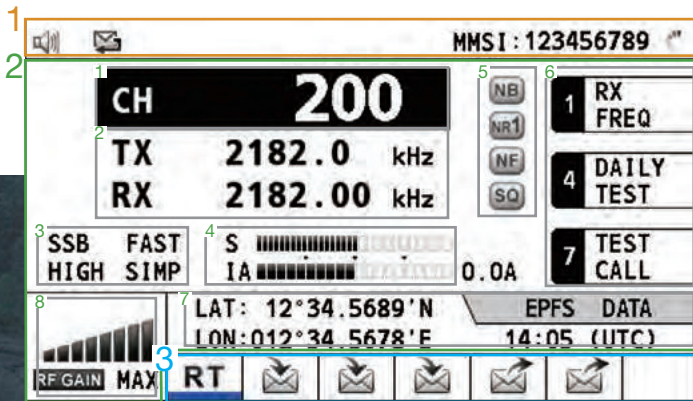

DSC SCAN display

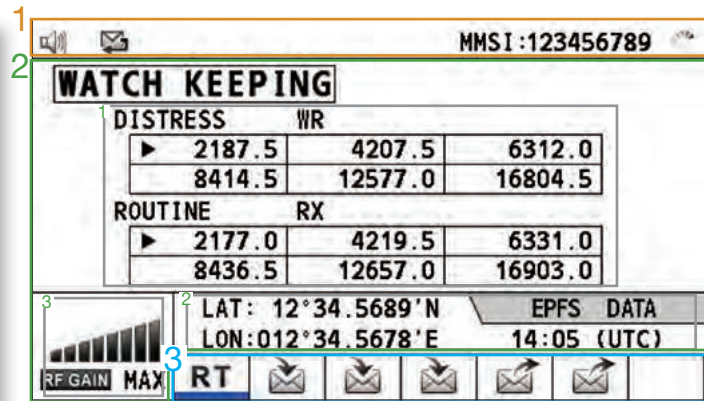

1 Status segment

Indicating the status of equipment, i.e., speaker ON/OFF, unread DSC message in the inbox, hardware error, etc. Also, MMSI is shown in radiotelephone and DSC scan displays.

2 Information segment

Displaying:

- 1 user channel selected
- 2 operating frequencies
- 3 class of emission, AGC, output power and communication mode
- 4 signal strength, meter reading (IC, VC, RF, VS and IA (antenna current))
- 5 currently activated functions, i.e., noise blanker, etc.
- 6 short-cut functions assigned for 1, 4 and 7 on the numeric keypad
- 7 own ship L/L, Time
- 8 indications of RF input attenuator ON/OFF as well as RF gain

2 Information segment

Displaying:

- 1 DSC watch frequencies (both distress and routine)
- 2 own ship L/L, Time
- 3 indications of RF input attenuator ON/OFF as well as RF gain

3 Tab segment

Up to 7 active procedures can be displayed in this segment. The procedures are for operating: radiotelephone, distress alert transmission, general DSC message transmission and general DSC message reception.

Quick-access functions



On the menu setting, three quick-access functions can be assigned for 1, 4 and 7 on the numeric keypad, and those assigned functions are displayed on the Radiotelephone display. The list of functions assigned for quick-access includes: TX frequency setting, RX frequency setting, class of emission setting, AGC setting, output power setting, TX frequency monitoring, showing the list of test messages, showing the list of message files, execution of daily test, showing the list of log files, and intercom functions.

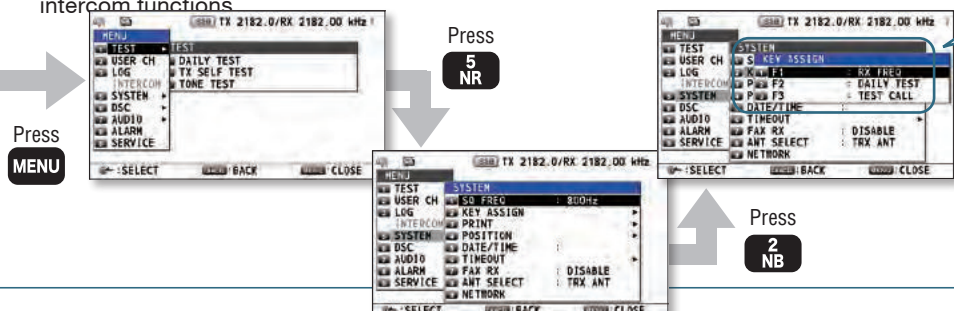

DSC display

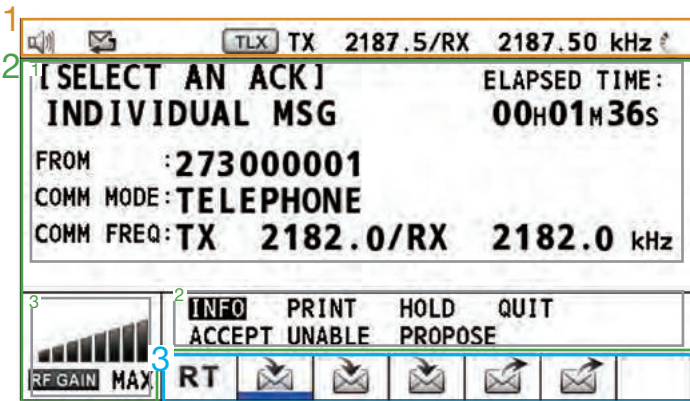

Menu display

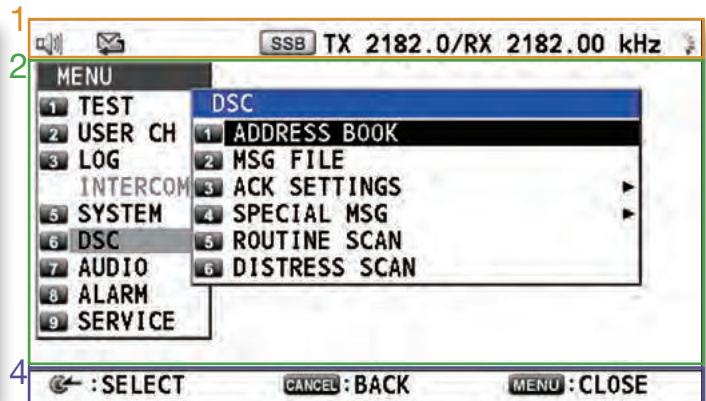

1 Status segment

Indicating status of equipment, i.e., speaker ON/OFF, unread DSC message in the inbox, hardware error, etc., TX/RX frequencies/class of emission for successive communication.

2 Information segment

Displaying:

- 1 DSC contents, status and information
- 2 a list of available operator actions
- 3 indications of RF input attenuator ON/OFF as well as RF gain

2 Information segment

Displaying menu tree

4 Guide segment

Guide to short-cut key functions is displayed.

mission, distress alert reception,

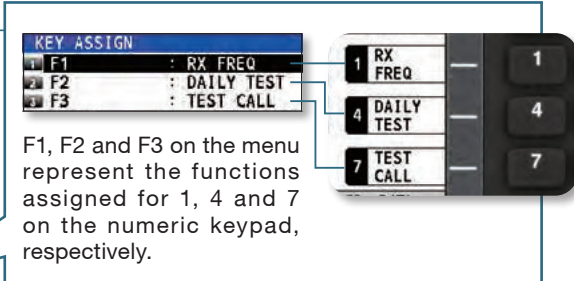

F1, F2 and F3 on the menu represent the functions assigned for 1, 4 and 7 on the numeric keypad, respectively.

Press 1



Night Mode

Night mode is selectable for wheelhouse operation.

Control Panel



Simplified menu operation

Numbers are assigned for each of the menu items, and the operator can access each of the menu items either by turning and pressing the PUSH TO ENTER knob to select menu items or simply pressing number on the numeric keypad.

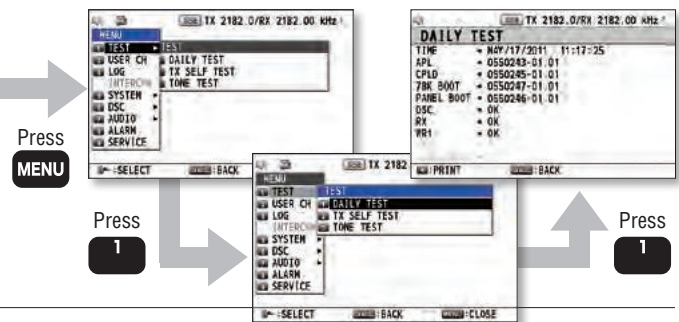

1	Volume/Power knob :	Sound volume control/Switching of Power ON/OFF
2	RF GAIN knob :	Adjustment of reception gain
	PUSH TO ATT :	Press to activate/deactivate RF attenuator
3	DISTRESS :	Long-press to transmit a DSC distress alert
4	DISTRESS MSG :	Composition of DSC message for distress alert
	OTHER DSC MSG :	Composition of DSC message except for distress alert and DROBOSE (DSC relay on behalf of someone else*)
	Press DISTRESS MSG + OTHER DSC MSG :	Composition of DSC message for DROBOSE
5	BRILL :	Activation of the brilliance control dialog box
	TAB :	Activation of tab segment control on the screen
	MENU :	Opening/closing of the menu dialog box
	CANCEL :	Deactivates alarm/deletion of error and pop-up messages/halting of DSC message composition/exiting from the message composition dialog box/distress cancellation/returning to a previous menu level
	[Speaker Icon] :	Switching the speaker ON/OFF
6	PUSH TO ENTER knob :	Shifts the selector and pointer/adjusts the degree of parameter, i.e., brilliance and switch over the display mode Press to confirm the entered values
7	SCAN :	Switches to the DSC SCAN mode/if pressed during the DSC SCAN mode, routine scan will be halted
	2182 :	Sets to 2182 kHz SSB
	RT/CH :	Switches to radiotelephone mode, and if pressed in radiotelephone mode, channel setting box will be summoned
	1 :	Used to enter the following number and symbols (. @ - _ / : 1) as well as quick access to short cut function
	2 NB :	Used to enter A, B, C and 2, and to switch noise blanker setting ON/OFF
	3 SQ :	Used to enter D, E, F and 3, and to switch squelch setting ON/OFF
	4 :	Used to enter G, H, I and 4 as well as quick access to short cut function
	5 NR :	Used to enter J, K, L and 5, and to switch noise reduction setting ON/OFF
	6 :	Used to enter M, N, O and 6
	7 :	Used to enter P, Q, R, S and 7 as well as quick access to short cut function
	8 NF :	Used to enter T, U, V and 8, and to switch notch filter ON/OFF
	9 :	Used to enter W, X, Y, Z and 9
	[Left Arrow] :	Used to reduce the receiver volume of the handset/to shift the pointer in channel/frequency selection dialog box
	0 TUNE :	Used to enter the number "0", space and the following symbols (! " # \$ % & ' () * + , - . / : ; < = > ? @ [\] ^ _ { } ~) / to tune impedance between an antenna and a transceiver
	[Right Arrow] :	Used to raise the receiver volume of the handset/to shift the pointer in channel/frequency selection dialog box

* composition and relay of the occurrence of a distress event obtained by non-DSC means

SPECIFICATIONS

MODEL	FS-1575	FS-2575	FS-5075
PRODUCT NAME	SSB RADIOTELEPHONE		

GENERAL CHARACTERISTICS

Rules and Regulations	ITU-R M.1082-1, ITU-R M.1173-1, ITU-R M.476-5, ITU-R M.490, ITU-R M.491-1, ITU-R M.492-6, ITU-R M.493-14, ITU-R M.541-10, ITU-R M.625-4, ITU-R M.821-1, IMO Res. A.694(17), IMO Res. A.806(19), IMO Res. MSC36 (63), IMO Res. MSC 68 (68), MSC/Circ. 862, IEC 61162-1 Ed. 4, IEC60945 Ed. 4, ETS 300 067 ed. 1, EN 300 338-1 V1.3.1, EN 300 338-2 V1.3.1, EN 301 033 V1.4.1, EN 300 373-1 V1.4.1		
Frequency Range	TX: RX:	1605.0kHz to 27500.0kHz 100kHz to 29999.99kHz	
Number of Channels	256 user-specified channels plus ITU, SSB/TELEX channels		
Communication Mode	Simplex/Semi-duplex		Simplex/Semi-duplex/Duplex (option)
Class of Emission	J3E, H3E, A1A, J2B		

TRANSCEIVER

RF Output Power	150 W pep	250 W pep	500 W pep (HF) / 400 W pep (MF)
Antenna	10-18 m whip or wire		
Tuning Speed	within 15 sec		
Receiver Sensitivity	less than +7 dBμV (4.0-29.99999 MHz, J3E) / less than +13 dBμV (1.6-4 MHz, J3E)		

DSC

Receiving	General	All DSC frequencies in MF/HF	
Frequency	Distress and safety	DSC distress/safety frequencies: 2187.5 kHz, 4207.5 kHz, 6312.0 kHz, 8414.5 kHz, 12577.0 kHz, 16804.5 kHz	
Message Storage	TX:	50 distress messages, plus 50 non-distress messages	
	RX:	50 messages, telephone no., frequencies, etc.	

POWER SUPPLY

24 VDC, 100/110/120/200/220/240 VAC with optional AC/DC Power Supply PR-850A (FS-2575/5075) / PR-241 × 2 (FS-1575)			
	20 A (TX), 5.0 A (RX)	40 A (TX), 5.0 A (RX)	60 A (TX), 5.0 A (RX)

EQUIPMENT LIST

Standard	1	Transceiver Unit	FS-1575T (FS-1575), FS-2575T (FS-2575), FS-5075T (FS-5075)	1	Unit
	2	Control Unit	FS-2575C	1	Unit
	3	Handset	HS-2003	1	Unit
	4	Antenna Coupler	AT-5075 (FS-2575/5075) AT-1575 (FS-1575)	1	Unit
Option	1	Printer	PP-520		
	2	Printer Interface	IF-8500		
	3	External Speaker	SEM-21Q		
	4	Control Unit	FS-2575C		
	5	NBDP Terminal Unit	IB-585		
	6	BK Interface	BK-300		
	7	Whip Antenna			
	8	AC/DC Power Supply	PR-850A (FS-2575/5075) PR-241 × 2 (FS-1575)		
	9	Full Duplex Kit (for FS-5075)	OP05-125		
	10	Matching Box	ARD-1		
	11	Preamp	FAX-5		
	12	WR2 kit	OP05-123		

INTERCONNECTION DIAGRAM

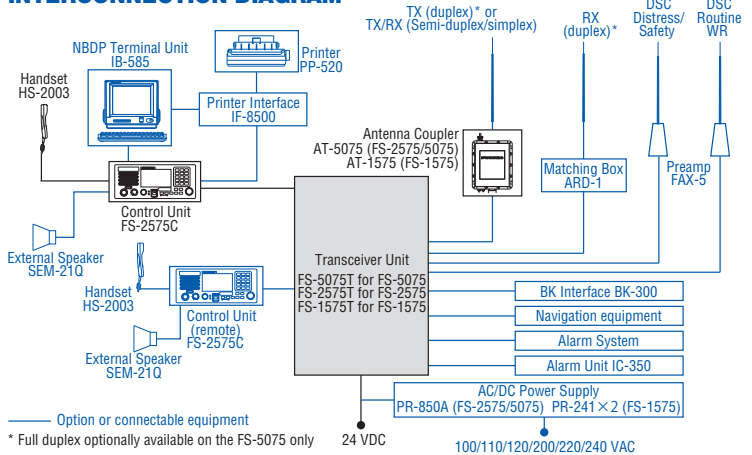

CONTROL UNIT

FS-2575C
1.9 kg 4.2 lb

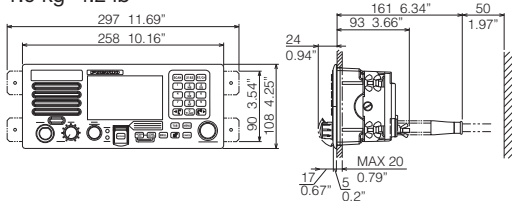

ANTENNA COUPLER

AT-5075
8.5 kg 18.7 lb

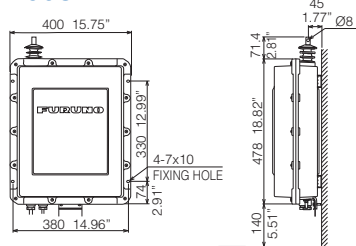

AT-1575 (Stainless type drawings)
2.6 kg 5.7 lb

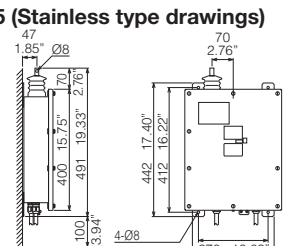

TRANSCEIVER UNIT

FS-5075T
27 kg 59.5 lb

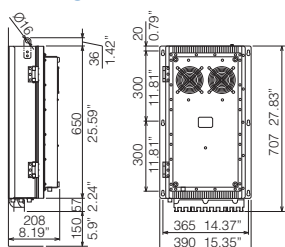

FS-2575T
20 kg 44.1 lb

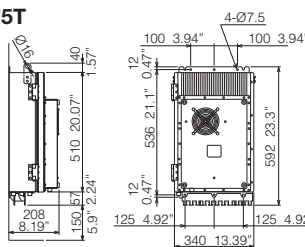

FS-1575T
16 kg 35.3 lb

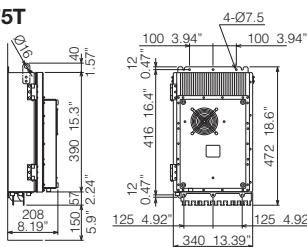

HANDSET

HS-2003
0.5 kg 1.2 lb

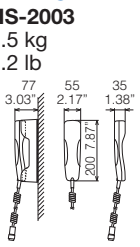

Beware of similar products

All brand and product names are registered trademarks, trademarks or service marks of their respective holders.

SPECIFICATIONS SUBJECT TO CHANGE WITHOUT NOTICE

FURUNO ELECTRIC CO., LTD.
Japan | www.furuno.com

FURUNO U.S.A., INC.
U.S.A. | www.furunousa.com

FURUNO PANAMA S.A.
Republic of Panama | www.furuno.com.pa

FURUNO (UK) LIMITED
U.K. | www.furuno.co.uk

FURUNO NORGE A/S
Norway | www.furuno.no

FURUNO DANMARK A/S
Denmark | www.furuno.dk

FURUNO SVERIGE AB
Sweden | www.furuno.se

FURUNO FINLAND OY
Finland | www.furuno.fi

FURUNO POLSKA Sp. z o.o.
Poland | www.furuno.pl

FURUNO DEUTSCHLAND GmbH
Germany | www.furuno.de

FURUNO FRANCE S.A.S.
France | www.furuno.fr

FURUNO ESPAÑA S.A.
Spain | www.furuno.es

FURUNO ITALIA S.R.L.
Italy | www.furuno.it

FURUNO HELLAS S.A.
Greece | www.furuno.gr

FURUNO (CYPRUS) LTD
Cyprus | www.furuno.com.cy

FURUNO SHANGHAI CO., LTD.
China | www.furuno.com/cn

FURUNO CHINA CO., LTD.
Hong Kong | www.furuno.com/cn

FURUNO KOREA CO., LTD
Korea

FURUNO SINGAPORE
Singapore | www.furuno.sg

PT FURUNO ELECTRIC INDONESIA
Indonesia | www.furuno.id

FURUNO ELECTRIC (MALAYSIA) SND. BHD.
Malaysia | www.furuno.my