



OPERATING AND SERVICE INSTRUCTIONS

**TWO-METER
TRANSMITTER/RECEIVER
MODEL SR-42A**

NOTE

ALL MENTION OF THE SR-42 IN THIS MANUAL ALSO REFERS TO THE SR-42A.

WARRANTY

The Hallicrafters Company warrants each new radio product manufactured by it to be free from defective material and workmanship and agrees to remedy any such defect or to furnish a new part in exchange for any part of any unit of its manufacture which under normal installation, use and service discloses such defect, provided the unit is delivered by the owner to our authorized radio dealer, wholesaler, from whom purchased, or, authorized service center, intact, for examination, with all transportation charges prepaid within ninety days from the date of sale to original purchaser and provided that such examination discloses in our judgment that it is thus defective.

This warranty does not extend to any of our radio products which have been subjected to misuse, neglect, accident, incorrect wiring not our own, improper installation, or to use in violation of instructions furnished by us, nor extended to units which have been repaired or altered outside of our factory or authorized service center, nor to cases where the serial number thereof has been removed, defaced or changed, nor to accessories used therewith not of our own manufacture.

Any part of a unit approved for remedy or exchange hereunder will be remedied or exchanged by the authorized radio dealer or wholesaler without charge to the owner.

This warranty is in lieu of all other warranties expressed or implied and no representative or person is authorized to assume for us any other liability in connection with the sale of our radio products.

the hallicrafters co.

1941 20000



Figure 1. Hallicrafters' Model SR-42A Two-Meter Transmitter/Receiver

156-006800

SECTION I GENERAL DESCRIPTION

1-1. INTRODUCTION

The Model SR-42 is a compact, self-contained two-meter radio station. Its compact size, ease of mounting, and universal power supply make the SR-42 ideally suitable as a 12-volt DC mobile unit as well as a 117-volt AC fixed-station unit. The unit is factory equipped with a transmitter crystal installed in position No. 1 for operation on 145.14 MC. Three other positions are available for four-channel transmitter operation. The receiver is tunable throughout the 144 to 148 MC band.

The only additional items required for AC operation are a high impedance microphone with push-to-talk switch and a suitable antenna.

A Model MR-40 Mobile Kit is required for 12-volt DC operation. This kit includes a heavy-duty vibrator, a DC power cable assembly, and the necessary brackets and hardware for mobile mounting.

Model HA-3 Noise Suppression Kit with instruction manual is available through Hallicrafters dealers to provide optimum noise free mobile operation.

NOTE

An FCC license is required by anyone operating this equipment.

1-2. FEATURES

The receiver used in the SR-42 is a double-conversion superheterodyne type, incorporating the following features:

- Low-noise, neutralized-nuistor RF stage.
- Low-noise triode first mixer.
- High-pass input filter.

Eleven tuned RF and IF circuits.
 Automatic full-time noise limiter.
 Zener-regulated variable oscillator.
 Crystal-controlled second oscillator.
 Double-spaced, copper-plate variable oscillator capacitor.
 Planetary drive for easier tuning.
 Dual tuning range for greater bandspread.
 Calibrated "S" meter.
 Heavy-duty speaker with a 3/4-inch voice coil and one-ounce Alnico V magnet.
 Adjustable threshold squelch.

Transmitter features include:
 High-frequency type CR-23/U crystals for less TVI.
 Automatic RF output meter switching.
 Frequency "SPOT" switch.
 Four panel switch selected crystal sockets.
 Provisions for external VFO.
 Microphone gain control.
 Convenient "Push-to-Talk" operation.
 High-quality, sealed, changeover relay.
 Hinged cover for easy access to crystal sockets and tubes.

SECTION II SPECIFICATIONS

RECEIVER

Sensitivity

1 microvolt for 10 DB S/N ratio (30% modulation).

Noise Figure

5-7 DB

Power Gain

0.5 watt for a one-microvolt, 30% modulated input.

AVC Figure of Merit

Better than 45 DB.

IF Rejection

Better than 85 db

Input Impedance

50 ohms (unbalanced).

Output Impedance

3.2 ohms.

Tuning Range

143.9-148.1 MC

IF Frequencies

20,15 MC and 1650 KC.

Reception Mode

Type A3 emission (AM).

TRANSMITTER

Power Input

12 to 14 watts

Tuning Range

143.75 to 148.1 MC (minimum).

Crystal Type

CR-23/U

Crystal Frequency

24 to 24.66 MC

or

Output Frequency/6
(Amateur Band Coverage).

Microphone Input

High impedance with "push-to-talk"

Frequency Response

-3DB at 300 and 3800 CPS.

Output Impedance

50 ohms (unbalanced).

Transmission Mode

Type A3 emission (AM).

GENERAL

NOTE

A Model MR-40 Kit is required for 12-volt mobile operation. This kit includes a heavy-duty vibrator, a DC power cable assembly and the necessary brackets and hardware for mobile mounting.

AC Operation

105/125 volts, 60 cycles, 65 watts maximum.

DC Operation

11/16 volts (negative ground), 6 amperes maximum.

Antenna Receptacle

Accepts Amphenol Type 83-ISP connector.

Microphone Receptacle

Accepts Amphenol Type 80-MC2M connector.

Number of Tubes

Eleven, Plus five diodes and two zener regulators.

Overall Dimensions (HWD)

5-1/2 by 12-1/8 by 8-1/4 inches.

Shipping Weight

17 pounds.

SECTION III INSTALLATION

3-1. UNPACKING

After unpacking the SR-42, examine it for damage which may have occurred in transit. Should any sign of damage be apparent, immediately file a claim with the carrier stating the extent of the damage. Carefully check all shipping labels and tags for instructions before removing or destroying them.

3-2. LOCATION

The SR-42 unit may be placed in any location that will permit free air circulation through the ventilation holes and openings in the cabinet.

In fixed-station use, avoid excessively warm locations such as those near radiators and heating vents. Also, avoid direct blasts of air from circulating fans, etc. Do not place any object on the cabinet cover that will impair natural ventilation. In mobile installations, avoid direct air blasts from heaters or air-conditioning units.

3-3. CONNECTION TO POWER SOURCE.

The SR-42 may be used for 117-volt, 60-cycle AC operation or 12-volt DC, negative ground operation by selecting the correct power cord and plug assembly.

In fixed installations where a 117-volt AC source will be used, the power cord with the

standard two-contact, molded plug on one end is used to connect to the AC outlet.

In mobile installations, the power lead with the in-line fuseholder is used. It is recommended that the bare end of this wire be connected directly to the positive (ungrounded) battery terminal. If additional length is required, wire no smaller than No. 14 AWG should be used. Connection of this lead to other points may cause instability due to poor voltage regulation, increased ignition interference, etc., which will impair normal operation.

CAUTION

The SR-42 is wired for 12-volt negative-ground operation. If it is desired to use this unit in vehicles having a 12-volt positive-ground system, it will be necessary to reverse the polarity of relay diode CR3 and relay electrolytic filter capacitor C68.

Also, the zener filament regulator CR6 must be insulated from the chassis and have its connections reversed. Special hardware and instructions are available through the Hallicrafter's Service Dept. An additional wire is required to be connected from the SR-42 chassis (screw terminal on rear) to the fire-wall or frame of the vehicle. This wire, No. 14 AWG or larger, completes the battery circuit.

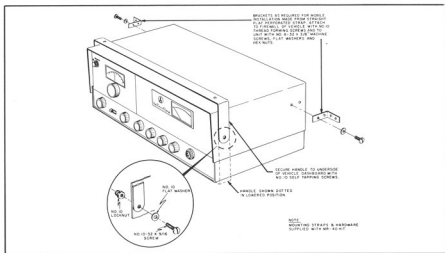

Figure 2. Mobile Installation of the SR-42 Unit.

156-004189-20

3-4. ANTENNAS

The SR-42 is designed for 50-ohm termination; therefore any two-meter antenna providing 50-ohm termination may be used. Antenna polarization is very important at these frequencies and should be considered when choosing an antenna. Generally speaking, the antenna polarization should be compatible with that of the stations you will normally contact.

The antenna should be connected to the antenna receptacle on the back of the unit, using RG-8/U or RG-58/U coaxial cable (RG-8/U is recommended for lengths in excess of 25 feet).

It is important that the antenna be adjusted for the lowest possible VSWR at your normal operating frequency. Additional information on antennas may be found in the ARRL Handbook or in the ARRL Antenna Manual.

3-5. VFO INPUT SOCKET CONNECTIONS

When the SR-42 XTAL-VFO switch is placed in the VFO position, it is possible to control the transmitter frequency from an external variable frequency oscillator.

The external oscillator should be capable of supplying 3 to 4 volts (RMS) across 150 ohms over a frequency range of 24 to 24.66 MC. The output of this oscillator should be connected to pin 6 and ground (pin 7) of the VFO socket which is mounted on the rear chassis apron.

4-

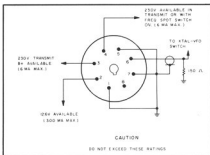

Figure 3. VFO Socket, Showing Pin Applications.

156-004147

Voltages are available at this socket to provide power for such a unit. (See figure 3).

3-6. HEADPHONES

The headphone jack, located on the rear chassis apron, is wired so that the internal speaker is automatically disabled when the headphone plug is inserted.

The headphone impedance is not critical; therefore phones up to 2000 ohms impedance will give good results.

SECTION IV

CONTROLS AND OPERATION

CAUTION

DO NOT APPLY POWER UNLESS THIS UNIT IS TERMINATED INTO AN ANTENNA OR DUMMY LOAD KNOWN TO BE NEAR 50 OHMS.

IN MOBILE OPERATION, TURN THE SR-42 OFF BEFORE ENGAGING THE ENGINE STARTER SWITCH. FAILURE TO DO SO MAY MATERIALLY SHORTEN THE LIFE OF THE POWER SUPPLY VIBRATOR.

4-1. CONTROLS

A. OFF - AF GAIN

After the antenna and power source connections have been made, rotate the gain control knob clockwise until a click is heard. The dial and meter windows should illuminate indicating that power is applied. Rotate control clockwise as necessary for desired audio output level.

B. REC. RANGE

This control selects a receiver tuning range of 144 to 146 MC or 146 to 148 MC.

If the control is set for 144-146, the upper, or 144 to 146 MC dial calibrations, should be used to indicate the frequency of reception.

If the control is set for 146-148, the lower, or 146- to 148-MC dial calibrations, should be used.

C. TUNING

This control rotates the dial and variable oscillator capacitor through a planetary drive system, to provide the desired frequency of reception. As mentioned in paragraph 4-1B, the dial calibrations used must correspond to the setting of the REC. RANGE control.

D. XTAL-VFO

This is a five-position switch used for selection of any one of four crystals which may be inserted into the corresponding sockets directly behind this control on the inside top of the chassis. In the fifth position, all crystal sockets

are disconnected and connection is made to pin No. 6 of the VFO socket for external VFO input between pin No. 6 and ground (pin No. 7).

E. GRID

This control is used to resonate the final amplifier input to the desired frequency. The 144-148 markings for this control are not calibration points but merely indicate the correct direction of rotation when tuning to a higher or lower operating frequency.

Always adjust this control for maximum upward meter deflection when in the "transmit" position, i.e., push-to-talk switch on microphone closed.

F. PLATE

This control is used to resonate the plate circuit of the final amplifier to the desired frequency. The same comments as in paragraph 4-1E apply to this control.

G. LOAD

This control adjusts the output coupling to provide optimum power transfer into the antenna load. There will be interaction between the PLATE and LOAD controls; therefore both should be adjusted repeatedly until no further upward meter deflection is obtained.

NOTE

The GRID, PLATE, and LOAD controls should always be adjusted for maximum upward meter deflection at the frequency of operation.

H. FREQ. SPOT

This switch, which should normally be in the OFF position, is used to apply plate voltage to the transmitter oscillator when in the "Receive" mode. This generates a strong unmodulated signal which may be tuned in on the receiver to indicate the frequency of transmission.

I. SQUELCH

The SQUELCH control is used to silence the receiver output in the absence of a

signal. In the fully counterclockwise position the squelch circuit is inoperative (i.e., no silencing). In practice, the SQUELCH control should be advanced clockwise just to the point where off signal background noise disappears. Advancing the control beyond this point will prevent weak signals from being heard. However, the S Meter will indicate the presence of a signal even though the output is squelched.

J. MIC. GAIN (Rear chassis apron)

This control is used to adjust the amount of audio applied to the carrier (percentage of modulation). The correct setting of this control may be determined by viewing the modulated RF output signal on an oscilloscope or by checking with operators of nearby stations. The control should be adjusted for maximum undistorted talk power. Do not attempt to over-modulate.

Once set, this control need not be readjusted unless the microphone is changed. Normal setting of this control will usually be approximately two-thirds clockwise rotation when viewed from chassis rear.

K. METER ZERO (Rear chassis apron)

This control provides an electrical zero adjustment of the meter to compensate for tube and component aging which normally occur.

1. To zero the meter, apply power to the SR-42 for at least fifteen minutes to allow circuit stabilization.
2. Remove the antenna and rotate the METER ZERO adjustment as necessary to cause the meter pointer to rest directly above the calibration mark at the extreme left end of the meter scale.

NOTE

This adjustment must be made in the "Receive" mode only.

4-2. RECEIVER OPERATION

To operate the SR-42 as a receiver, proceed as follows:

1. Connect a two-meter, 50-ohm antenna to the ANTENNA receptacle located on the rear apron of the chassis.
2. Connect AC or 12-VDC power cord to an appropriate voltage source.
3. Rotate OFF-AF GAIN control clockwise until a click is heard. The dial

and meter windows should illuminate, indicating that power has been applied.

4. Adjust AF GAIN control for desired audio output level.
5. Set REC. RANGE to the desired range.
6. Rotate TUNING control to the desired frequency.

NOTE

The dial calibration used must correspond to the setting of the REC RANGE control.

4-3. TRANSMITTER OPERATION

To operate the SR-42 as a transmitter, proceed as follows:

1. Connect antenna and power source.
2. Connect microphone to MIC receptacle.
3. Insert desired crystal into one of the four crystal sockets which will be found directly behind the XTAL-VFO switch on the chassis top.
4. Rotate XTAL-VFO switch to the corresponding XTAL position.
5. Preset GRID, PLATE and LOAD control knobs to mid-rotation (dot straight up).
6. Depress and hold microphone push-to-talk switch in the closed position.
7. Adjust GRID, PLATE and LOAD controls for maximum upward meter deflection. Repeat adjustments until no further increase in meter reading is obtainable.
8. Release push-to-talk switch.
9. Rotate the MIC GAIN control, located on rear chassis apron, to approximately two thirds of full rotation in a clockwise direction (When viewed from chassis rear). See paragraph 4-1J for complete information on adjustment of this control.
10. The SR-42 is now ready for transmission.

NOTE

Do not attempt to operate near the band edge unless accurate frequency measuring instruments are available to insure that all of the transmitted signal is within the specified band limits. Do not attempt to over-modulate.

- The frequency of transmission can be "spotted" on the receiver dial by placing the **FREQ SPOT** switch in the **ON** position and tuning the receiver until a strong unmodulated signal is heard.
- Return the **FREQ SPOT** switch to the **OFF** position.

NOTE

If the operating frequency is changed, the **GRID**, **PLATE**, and **LOAD** controls should be readjusted for maximum output.

4-4. TRANSMITTER CRYSTALS

High-frequency transmitter crystals similar to those used in citizens band and other modern day equipment are used to minimize spurious outputs generated in the process of high-order multiplication.

These crystals are readily available from any of the well-known crystal manufacturers. To order crystals proceed as follows:

- Divide the desired operating frequency by 6 to determine the crystal frequency.

Example: The desired operating frequency is

$$\frac{147}{6} = 24.500 \text{ MC (crystal frequency).}$$

- The crystal order of the manufacturer should contain the following information:

Crystal Type - CR-23/U

Crystal Frequency - 24.500 MC.

SECTION V THEORY OF OPERATION

5-1. RECEIVER (Figure 4)

An RF signal (144 to 148-MC) is applied to the antenna input and is fed through the high-pass filter and the changeover relay, to the broadband antenna coil. The signal is transformed to a higher impedance and the resultant voltage is applied to the grid of the neutralized 13CW4 nuvistor where it is amplified.

After amplification, the signal is fed through a 144- to 148-MC bandpass coupler to the first mixer stage. Here it is heterodyned with the voltage developed by the variable oscillator to produce a difference or IF frequency of 20.15 MC.

The variable oscillator has a basic tuning range of 61.925 to 62.925 MC which is doubled to provide a tuning range of 144 to 146 MC. In the 146 to 148-MC range, a coil is connected in parallel with the oscillator coil to shift the doubled oscillator tuning range exactly two megacycles higher in frequency. The oscillator plate voltage is

controlled by a zener regulator to maintain stable operation over a wide range of input voltage variations. In mobile operation, the oscillator filament voltage is also zener regulated to compensate for the wide range of input voltage variations normally encountered in mobile operation.

The 20.15-MC first IF signal is fed through a double-tuned transformer to the grid of the second mixer where it is heterodyned with the output of an 18.5-MC crystal-controlled oscillator to produce a second IF frequency of 1650 KC.

The 1650-KC IF signal is fed through three double-tuned transformers and two amplifier stages to the envelope detector where the signal is rectified to produce an audio signal and AVC voltage.

The AVC voltage after filtering is applied to both 1650-KC IF amplifiers and to the RF amplifier to provide automatic gain control.

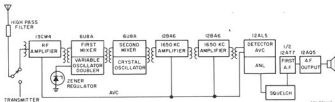

Figure 4. Receiver Block Diagram.

100-30640

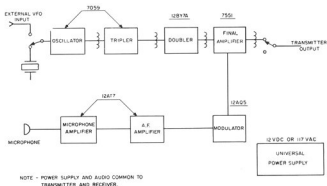

Figure 5. Transmitter Block Diagram.

154 004511

The audio signal, after RF filtering, is fed through the automatic, self-adjusting noise-limiter circuitry to the AF GAIN control. From the receiver audio gain control, it is fed through the squelch diode to a set of relay contacts, two audio stages, and the output transformer to the speaker. It should be noted that these two audio stages and the output transformer, as well as a microphone preamplifier stage, are used to modulate the transmitter.

In the "Receive" position, the antenna is connected to the receiver input, plate voltage is removed from the transmitter oscillator, tripler and doubler stage, the microphone preamplifier plate voltage is removed, the receiver audio is connected to the audio amplifier, the speaker voice coil circuit is completed, and the final transmitter amplifier cathode circuit is opened.

5-2. TRANSMITTER (Figure 5)

The transmitter signal is generated in the triode section of the 7059 oscillator/tripler stage. This may be done by using a crystal or by placing the XTAL-VFO switch in VFO position and feeding in an external signal of the proper amplitude and frequency. The output of the triode section is broad tuned to cover the 24- to 24.66-MC range.

The 24- to 24.66-MC signal is applied to the pentode or tripler section of the same tube to develop a signal in the 72- to 74-MC range. The output of this stage is fed through a bandpass coupler and applied to the grid of the 12BY7A doubler stage. Here, the frequency is doubled to 144 to 148 MC.

This signal is fed to the final amplifier stage for further amplification. The output of the final amplifier is connected to a link-coupled tank circuit to resonate the plate circuit and transform the amplifier plate impedance to the desired 50 ohms. The signal is then fed through a set of relay contacts and high pass filter to the ANTENNA receptacle.

Modulation of the plate and screen circuits of the final amplifier is accomplished in the conventional manner. The degree, or percentage, of modulation, is controlled by adjustment of the MIC GAIN control on the rear chassis apron.

In the "transmit" mode, voltage is removed from RF, mixers and IF stages of the receiver, the antenna is connected to the transmitter, the speaker voice coil circuit is opened, the final amplifier cathode circuit is completed and voltage is applied to the microphone preamplifier as well as the transmitter oscillator tripler and doubler stages.

5-3. POWER SUPPLY

The power supply used is of the universal, full-wave voltage-doubler type. Silicon rectifiers are used for good voltage regulation and reduced heat. Either 117-VAC or 12-VDC operation is available by proper choice of power cord and plug assemblies. All connections are made automatically when the cords are changed. A heavy-duty vibrator is used for DC operation.

5-4. "S" METER-RF OUTPUT METER

A bridge circuit is used to provide a forward reading meter which is used in Receive and Transmit. Plate current for the two AVC-controlled IF amplifier tubes is measured by the meter and is proportional to the AVC voltage (or incoming signal strength). The meter is calibrated in "S" units to 9 and in decibels above S9. S9 will represent an incoming signal of 50 microvolts at the ANTENNA receptacle.

In Transmit, a small portion of the RF output signal is rectified and filtered. This rectified current is measured by the meter and gives an indication of the relative output of the transmitter. When the SR-42 is terminated into 50 ohms, the meter will read between one-half and three-quarters of full scale at maximum transmitter output. Readings above or below this level indicate incorrect antenna termination or improper tuning.

SECTION VI SERVICE DATA

6-1. CHASSIS REMOVAL

1. Remove power cable.
2. Disconnect antenna.
3. Disconnect microphone.
4. Remove six screws in cabinet bottom.
5. Slide chassis forward in cabinet to remove.

NOTE

Hinged cover provides easy access to pilot lights, tubes, crystals, etc.

6-2. SERVICE AND OPERATING QUESTIONS.

For further information regarding operation or servicing of this equipment, contact the dealer from whom the unit was purchased. The Hallicrafters Company maintains an extensive system of Authorized Service Centers where any required service will be performed promptly and efficiently at no charge if this equipment is delivered to the service center within 90 days from date of purchase by the original buyer and the defect falls within the terms of the warranty. It is necessary to present the bill of sale in order to establish warranty status. After expiration of the warranty, repairs will be made for a nominal

charge. All Hallicrafters Authorized Service Centers display the sign shown below. For the location of the one nearest you, consult your dealer or telephone directory.

Make no service shipments to the factory as The Hallicrafters Company will not accept responsibility for unauthorized shipments.

The Hallicrafters Company reserves the privilege of making revisions in current production of equipment and assumes no obligation to incorporate such revisions in earlier models.



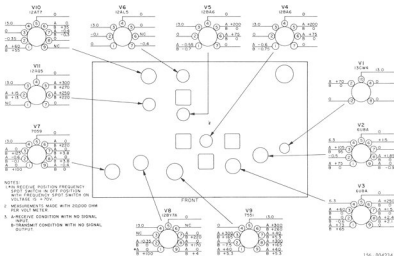

Figure 6. Voltage Chart.

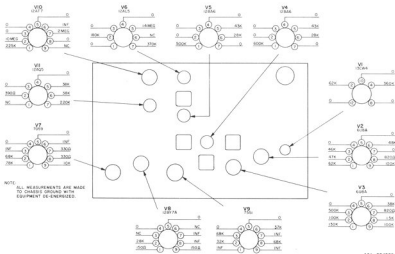

Figure 7. Resistance Chart.

SECTION VII ALIGNMENT

7-1. GENERAL

Alignment should not be attempted until all other possible causes of faulty operation have been exhausted.

NOTE

Do not make any adjustments unless the operation of this unit is fully understood and adequate test equipment is available.

7-2. TEST EQUIPMENT REQUIRED (Receiver)

1. Signal generator with 1650-KC to 148-MC coverage, 50-ohm termination impedance, and 30%, 400-cycle modulation.
2. Audio output meter providing 3,2-ohm termination. The AC scale of a VTVM may be used, in which case a 3- or 4-ohm, 2-watt resistive load should be used.

7-3. INITIAL CONTROL SETTINGS

NOTE

Disconnect speaker and terminate output transformer secondary with 3.2-ohm load. Connect output meter across load. Allow at least fifteen minutes warmup before making any adjustment.

TUNING 146 MC
REC RANGE 144 to 146 MC
AF GAIN Fully advanced.
SQUELCH OFF

7-4. 1650-KC IF ALIGNMENT

1. Connect the hot lead from the signal generator through a 0.01-to 0.05-mfd. capacitor to pin 2 of V3 (ground shield of generator lead to the chassis).
2. Set generator at 1650 KC (30%, 400-cycle modulation) and increase level as necessary to obtain indication on audio output meter.
3. Adjust top and bottom cores of T4, T3, and T2 for maximum audio output. Keep generator output at the lowest practical level.

7-5. 20.15-MC IF ALIGNMENT

1. Connect hot lead of signal generator through a 0.01 to 0.05-mfd. capacitor to pin 9 of V2 (shield to chassis).
2. Set generator at 20.15 MC (30%, 400-cycle modulation) and adjust top and bottom cores of T1 for maximum audio output. Keep generator output at the lowest practical level.

NOTE

With certain core settings in the 20.15-MC IF, the 18.5-MC oscillator will not oscillate, causing the receiver to appear dead. Should this occur, rotate the transformer cores one or two turns, or until a signal can be found.

7-6. ANTENNA AND BANDPASS ALIGNMENT

1. Connect signal generator to ANTENNA input receptacle.
2. Set generator at 146 MC (30%, 400-cycle modulation) and adjust L1, L2, and L3 for maximum audio output.
3. Tune receiver and generator to 144 MC and adjust L1 and L3 for maximum audio output.
4. Tune receiver and generator to 148 MC and adjust L2 for maximum audio output.
5. Check for uniform gain at 144, 146 and 148 MC. If the variation is greater than 3 DB, repeat the above adjustments.

7-7. VARIABLE OSCILLATOR ADJUSTMENT

1. Disconnect output termination and meter, and connect speaker.
2. Set receiver dial at 144 MC. (REC. RANGE switch at 144 to 146 MC).
3. Set generator at 144 MC (modulated).
4. Adjust oscillator coil L5 until a signal is heard.
5. Set receiver dial to 146 MC.

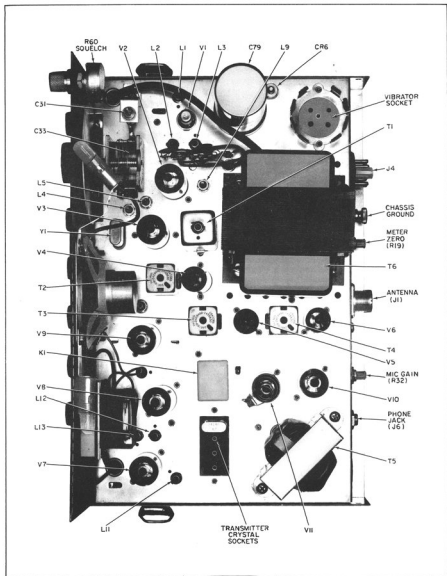

Figure 8. Top View of Chassis, Showing Component Locations.

154-006482

6. Set generator to 146 MC.
7. Adjust trimmer C31 until a signal is heard.
8. Repeat these adjustments until the calibration is correct at 144 and 146 MC.
9. Set REC RANGE switch to 146 to 148 MC.
10. Set receiver dial to 146 MC.
11. Set generator to 146 MC.
12. Adjust coil L4 until a signal is heard.
13. There may be some interaction between the two coil adjustments; therefore, the above adjustments should be repeated, if necessary, for accurate calibration.

NOTE

Small errors in calibration in the 144- to 146-MC range may be corrected by slight readjustment of trimmer C31 only. Calibration in the 146- to 148-MC range should not be attempted until calibration has been established in the 144- to 146-MC range. Adjustment of the 146- to 148-MC range must be made by coil L4.

7-8. RECEIVER OSCILLATOR MULTIPLIER COIL ADJUSTMENT.

1. Set receiver dial at 146 MC.
2. Adjust coil L9 for maximum increase in circuit noise (no signal).

7-9. HIGH PASS FILTER COIL ADJUSTMENT

1. Set receiver dial at 146 MC.
2. Set signal generator at approximately 106 MC and increase generator output to 10,000 microvolts.
3. Adjust generator tuning slightly until a signal is heard.

4. Adjust core in L8 for minimum receiver output.

7-10. TRANSMITTER OSCILLATOR COIL ADJUSTMENT

1. This adjustment should be made with a 24.66-MC crystal installed in the transmitter. If a 24.66-MC crystal is not available, select the highest frequency crystal that you intend to use.
2. Tune the transmitter in the normal manner for maximum output.
3. Adjust the core of coil L11 for maximum upward RF output meter deflection and then back the core out approximately one-quarter turn (high frequency side of resonance) to ensure oscillator starting.

NOTE

If no transmitter output can be obtained, turn core of coil L11 out of coil winding approximately two turns or until an indication of RF output is obtained and then make adjustment as described above.

7-11. TRANSMITTER BANDPASS ADJUSTMENT

If the transmitter power output is uniform across the 144- to 148-MC range, no adjustment should be made. If adjustment is found to be necessary, proceed as follows:

1. Insert crystal which will give output near 148 MC and tune transmitter for maximum output.
2. Adjust core in L12 for maximum output.
3. Insert crystal which will give output near 144 MC and tune transmitter for maximum output.
4. Adjust core in L13 for maximum output. Repeat adjustments until power output is uniform at 144 and 148 MC.

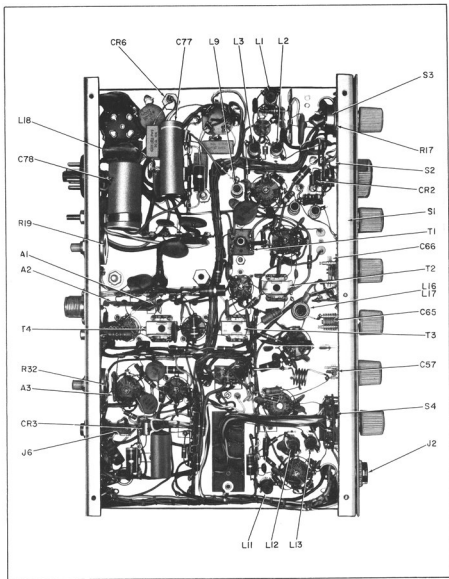

Figure 9. Bottom Chassis View, Showing Component Locations

156 004528

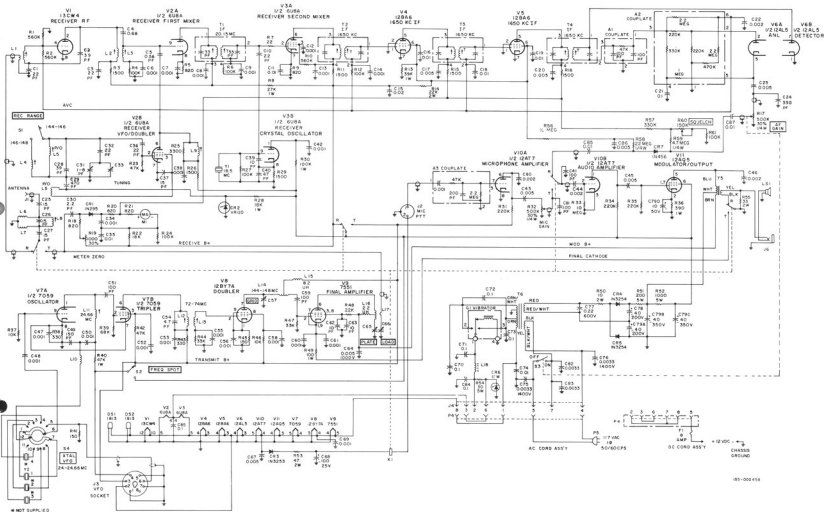

Figure 10. Schematic Diagram of Model SR-42A.

NOTE:
UNLESS OTHERWISE SPECIFIED,
ALL RESISTORS ARE IN OHMS $\pm 10\%$, $1/2$ WATT.
ALL CAPACITORS ARE IN MICROFARADS (SEE
PARTS LIST FOR VOLTAGE RATINGS).

